

FEATURES

- Range of input voltages: 10-18V, 18-36V, 36-75V
- Models include:
 - 3.3V @ 3.5A or 6A
 - 5V @ 3.5A or 6A
 - 15V @ 1.2A
 - 12V @ 1.4A

- Guaranteed efficiencies to 89%
- 15-30 Watts in 1" x 2" package
- 340kHz synchronous-rectifier topologies
- -40 to +60/70°C ambient w/o derating
- Fully isolated (1500Vdc); I/O protected
- Trim and On/Off Control
- Designed to meet UL1950/EN60950 certifications
- CE mark (75VIN models)

PRODUCT OVERVIEW

UEP Series DC/DC Converters deliver the most power/current (up to 6A/6Amps) from a 1" x 2" package. And because of their footprint compatibility, they are a great drop in replacements for their bigger siblings, the standard 2" x 2" and 1.6" x 2" devices, commonly used in the industry.

By combining a high frequency (340kHz), high-efficiency (to 89%), synchronous-rectifier topology with the newest components and time-tested, fully automated, SMT-on-pcb construction, these UEP Models are able to bring you 15-30W in the standard 2" x 1" package from which most competitors can only get 5-10W. All UEP's deliver their full output power over ambient temperature ranges from -40°C to as high as +70°C (model and input voltage dependent) without heat sinks or supplemental forced-air cooling. Devices derate to +100°C.

Output voltages are 3.3, 5, 12 or 15 Volts. Input voltage ranges are 10-18V ("D12" models), 18-36V ("D24" models) or 36-75V ("D48") models. All models feature input pi filters, input undervoltage and overvoltage lockout, input reverse-polarity protection, output overvoltage protection, output current limiting, and continuous



Typical units

short-circuit protection. Standard features also include on/off control and output-trim. All models are designed to meet IEC950, UL1950 and EN60950 safety requirements for OPERATIONAL insulation. "D48" models (36-75V inputs) are CE marked.

UEP Series DC/DC's are packaged in low-cost, light-weight, diallyl phthalate (UL94V-0 rated) plastic packages with standoffs. EMC compliance is achieved via a low-noise design rather than through expensive metal shielding.

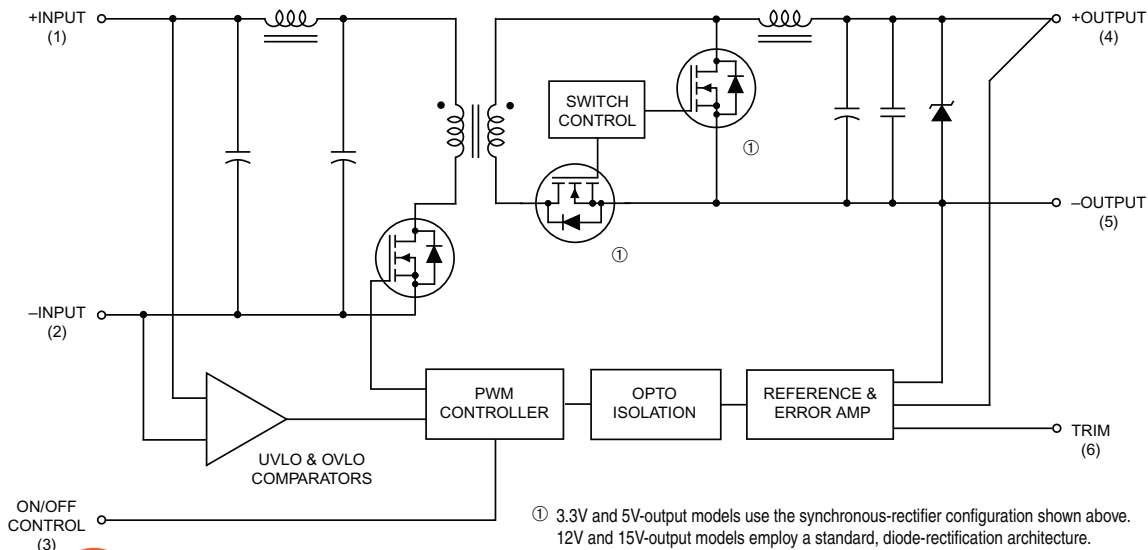

Figure 1. Simplified Schematic

Typical topology is shown.



Performance Specifications and Ordering Guide ①

Model	Output						Input			Efficiency		Package (Case, Pinout)
	V _{out} (Volts)	I _{out} (mA)	R/N (mVp-p)		Regulation (Max.)		V _{in} Nom. (Volts)	Range (Volts)	V _{out} (mA)	Min.	Typ.	
			Typ.	Max.	Line	Load ③						
UEP-3.3/4500-D12	3.3	4500	85	100	±0.2%	±0.5%	12	10-18	80/1490	83.5%	84.5%	C15, P21
UEP-3.3/4500-D24	3.3	4500	85	100	±0.2%	±0.5%	24	18-36	50/730	85.5%	87.5%	C15, P21
UEP-3.3/4500-D48	3.3	4500	85	100	±0.2%	±0.5%	48	36-75	35/360	85.5%	87.5%	C15, P21
UEP-3.3/6000-D48	3.3	6000	85	100	±0.2%	±0.3%	48	36-75	40/470	86%	88%	C15, P21
UEP-5/3500-D12	5	3500	85	100	±0.2%	±0.5%	12	10-18	120/1760	84%	86%	C15, P21
UEP-5/3500-D24	5	3500	85	100	±0.2%	±0.5%	24	18-36	65/850	86%	88%	C15, P21
UEP-5/3500-D48	5	3500	85	100	±0.2%	±0.5%	48	36-75	40/430	86%	88%	C15, P21
UEP-5/6000-D48	5	6000	85	100	±0.2%	±0.3%	48	36-75	35/710	88%	91%	C15, P21
UEP-12/1400-D12	12	1400	85	100	±0.2%	±0.5%	12	10-18	60/1650	82.5%	85%	C15, P21
UEP-12/1400-D24	12	1400	85	100	±0.2%	±0.5%	24	18-36	45/800	85%	87%	C15, P21
UEP-12/1400-D48	12	1400	85	100	±0.2%	±0.5%	48	36-75	20/400	85%	87%	C15, P21
UEP-15/1200-D12	15	1200	85	100	±0.2%	±0.5%	12	10-18	60/1760	82.5%	85%	C15, P21
UEP-15/1200-D24	15	1200	85	100	±0.2%	±0.5%	24	18-36	45/860	85%	87%	C15, P21

① Typical at TA = +25°C under nominal line voltage and full-load conditions, unless otherwise noted.

② Ripple/Noise (R/N) is tested/specified over a 20MHz bandwidth. All models are specified with no external input/output capacitors.

③ Load regulation is specified over no load to 100% load conditions for 3.3 and 5V_{out} models, 25mA to 100% load conditions for 12 and 15 V_{out} models.

④ Nominal line voltage, no-load/full-load conditions.

PART NUMBER STRUCTURE

U EP - 3.3 / 4500 - D48 N - C

Output Configuration:
U = Unipolar

External Pinout

Nominal Output Voltage:
3.3, 5, 12 or 15 Volts

Input Voltage Range:
D12 = 10-18 Volts (12V nominal)
D24 = 18-36 Volts (24V nominal)
D48 = 36-75 Volts (48V nominal)

Maximum Output Current
in mA

ROHS-6
Hazardous Substance Compliance

N Suffix
Available for 12V_{out} and 15V_{out} Models

Optional Functions

UEP converters are designed such that the 12 and 15V_{out} models can be configured for either positive logic on/off control (no suffix) or negative logic ("N" suffix). 3.3 and 5V_{out} models are available with positive logic only (no suffix).

No Suffix On/Off Control function (positive polarity) on pin 3

N On/Off Control function (negative polarity) on pin 3. (12V and 15V models only)

MECHANICAL SPECIFICATIONS

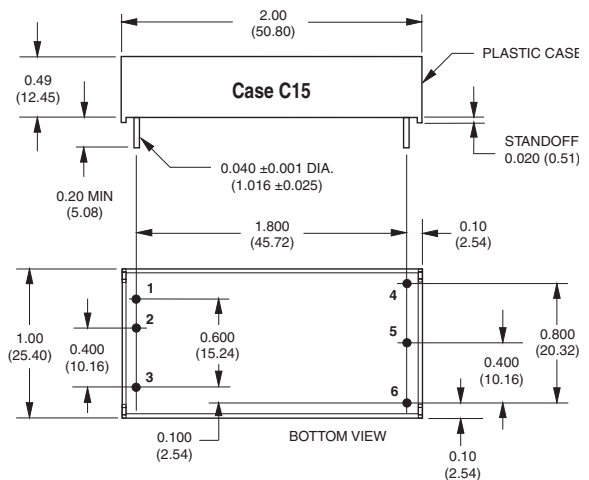

I/O Connections	
Pin	Function P21
1	+Input
2	-Input
3	On/Off Control
4	+Output
5	-Output
6	Trim

Dimensions are in inches (mm shown for ref. only).

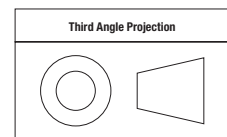

Tolerances (unless otherwise specified):
.XX ± 0.02 (0.5)
.XXX ± 0.010 (0.25)
Angles ± 2°

Components are shown for reference only.

Performance/Functional Specifications

Typical @ T_A = +25°C under nominal line voltage and full-load conditions, unless noted. ① ②

Input	
Input Voltage Range:	
D12 Models	10-18 Volts (12V nominal)
D24 Models	18-36 Volts (24V nominal)
D48 Models	36-75 Volts (48V nominal)
Overvoltage Shutdown:	
D12 Models	18.5-21 Volts (20V typical)
D24 Models	37-40 Volts (38V typical)
D48 Models ⑦	77-81 Volts (78.5V typical)
Start-Up Threshold: ③	
D12 Models	9.3-9.8 Volts (9.6V typical)
D24 Models	16.5-18 Volts (17V typical)
D48 Models	34-36 Volts (35V typical)
Undervoltage Shutdown: ③	
D12 Models	7-8.5 Volts (8V typical)
D24 Models	15.5-17.5 Volts (16.5V typical)
D48 Models	32.5-35.5 Volts (34.5V typical)
Input Current:	
Normal Operating Conditions	See Ordering Guide
Standby Mode (Off, OV, UV)	5mA
Input Filter Type	Pi
Reverse-Polarity Protection	Brief duration, 10A maximum
On/Off Control (Optional, Pin 3): ④	
D12, D24, & D48 Models	On = open or 13V - +V _{IN} , I _{IN} = 50μA max. Off = 0-0.8V, I _{IN} = 1mA max.
D12N, D24N, & D48N Models	On = 0-0.5V, I _{IN} = 50μA max. Off = open or 2.4-10V, I _{IN} = 3.7mA max.
Output	
V_{OUT} Accuracy (50% load):	±1.5%, maximum
Minimum Loading: ②	
3.3V/5V Outputs	No load
12V/15V Outputs	25mA
Ripple/Noise (20MHz BW) ① ⑤	See Ordering Guide
Line/Load Regulation	See Ordering Guide
Efficiency	See Ordering Guide
Isolation Voltage:	
Input-to-Output	1500Vdc minimum
Isolation Capacitance	470pF
Isolation Resistance	100MΩ
Current Limit Inception: ③	
6A Models	7-8 Amps
4.5A Models	5.5-7 Amps (6.25 Amps typ.)
3.5A Models	5.5-6 Amps (5.25 Amps typ.)
1.4A Models	1.9-2.7 Amps (2.3 Amps typ.)
1.2A Models	1.5-2.1 Amps (1.8 Amps typ.)
Short Circuit: ③	
Average Current	Hiccup, indefinite 3 Amps maximum
V_{OUT} Trim Range ③	±5%
Overvoltage Protection ③	Zener/transorb clamp, magnetic feedback
Temperature Coefficient	±0.02% per °C. Dynamic Characteristics
Dynamic Characteristics	
Transient Response (50-100% load)	300μsec max. to ±1.5% of final value
Start-Up Time: ③	
V _{IN} to V _{OUT}	50msec
On/Off to V _{OUT}	30msec

Dynamic Characteristics (continued)	
Switching Frequency	
6A Models	400kHz (±20kHz)
1.2A-4.5A Models	340kHz (±40kHz)
Environmental	
Operating Temperature (Ambient):	
Without Derating ⑥	-40 to +60/70°C
With Derating	to +100°C (See Derating Curves)
Case Temperature:	
Maximum Allowable	+100°C
Storage Temperature	-40 to +105°C
Physical	
Dimensions	2" x 1" x 0.51" (51 x 25 x 12.95mm)
Shielding	None
Case Material	Diallyl phthalate, (UL94V-0 rated)
Pin Material	Gold-plated copper alloy with nickel underplate
Weight	1.4 ounces (39.7 grams)

- ① All models are specified with no external input/output capacitors.
- ② See Minimum Output Loading Requirements under Technical Notes.
- ③ See Technical Notes for details.
- ④ The On/Off Control is designed to be driven with open-collector logic or the application of appropriate voltages (referenced to -Input (Pin 2)). Applying a voltage to the On/Off Control pin when no input voltage is applied to the converter may cause permanent damage. See Technical Notes.
- ⑤ Output noise may be further reduced with the addition of external output capacitors. See Technical Notes.
- ⑥ Operating temperature range without derating is model and input-voltage dependent. See Temperature Derating.
- ⑦ UEP-3.3/600-D48 and UEP-5/6000-D48 do not have overvoltage shutdown. See Absolute Maximum Ratings for allowable input voltages.

Absolute Maximum Ratings	
Input Voltage:	
Continuous:	
D12 Models	22 Volts
D24 Models	44 Volts
D48 Models	88 Volts
Transient (100msec):	
D12 Models	22 Volts
D24 Models	44 Volts
D48 Models	88 Volts
Input Reverse-Polarity Protection	Current must be <10 Amps. Brief duration only. Fusing recommended.
Output Overvoltage Protection:	
3.3V Outputs	4.5 Volts, unlimited duration
5V/12V/15V Outputs	6.8/15/18 Volts, unlimited duration
Output Current	Hiccup. Devices can withstand sustained output short circuits without damage.
Case Temperature	+100°C
Storage Temperature	-40 to +105°C
Lead Temperature	See soldering guidelines

These are stress ratings. Exposure of devices to greater than any of these conditions may adversely affect long-term reliability. Proper operation under conditions other than those listed in the Performance/Functional Specifications Table is not implied.

TECHNICAL NOTES

Floating Outputs

Since these are isolated DC/DC converters, their outputs are "floating." Designers will usually use the -Output (pin 5) as the ground/return of the load circuit. You can, however, use the +Output (pin 4) as ground/return to effectively reverse the output polarity.

Minimum Output Loading Requirements

3.3 and 5V models employ a synchronous-rectifier design topology. All models regulate within spec and are stable under no-load conditions. 12/15V models employ a traditional forward, diode-rectification architecture and require 25mA loading to achieve their listed regulation specs. Operation under 25mA load conditions will not damage the 12/15V devices; however they may not meet all listed specifications.

Filtering and Noise Reduction

All UEP Series DC/DC Converters achieve their rated ripple and noise specifications with no external input/output capacitors. In critical applications, input/output noise may be further reduced by installing external I/O caps. Input capacitors should be selected for bulk capacitance, low ESR and high rms-ripple-current ratings. Output capacitors should be selected for low ESR and appropriate frequency response. All caps should have appropriate voltage ratings and be mounted as close to the converters as possible. The most effective combination of external I/O capacitors will be a function of load and layout conditions.

Input Fusing

Certain applications and/or safety agencies may require the installation of fuses at the inputs of power conversion components. Fuses should also be used if the possibility of sustained, non-current-limited, input-voltage polarity reversals exists. For DATEL UEP Series DC/DC Converters, you should use slow-blow type fuses with values no greater than the following.

VIN Range	Fuse Value
D12 Models	3 Amps
D24 Models	2 Amps
D48 Models (1.2-4.5A)	1 Amp
D48 Models (6A)	2 Amp

Trimming Output Voltages

These converters have a trim capability (pin 6) that allows users to adjust the output voltage $\pm 5\%$. Adjustments to the output voltage can be accomplished via a trim pot, Figure 2, or a single fixed resistor as shown in Figures 3 and 4. A single fixed resistor can increase or decrease the output voltage depending on its connection. Fixed resistors should have an absolute TCR less than 100ppm/ $^{\circ}$ C to minimize sensitivity to changes in temperature.

A single resistor connected from the Trim (pin 6) to the +Output (pin 4), see Figure 3, will decrease the output voltage. A resistor connected from the Trim (pin 6) to -Output (pin 5) will increase the output voltage.

Trim adjustment greater than 5% can have an adverse effect on the converter's performance and is not recommended.

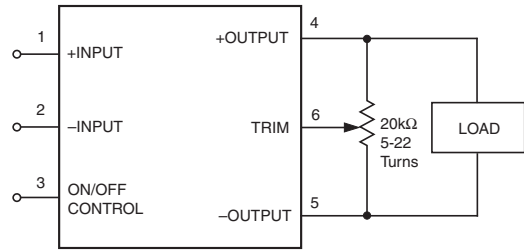

Figure 2. Trim Connections Using A Trim Pot

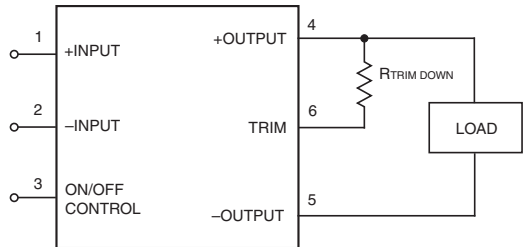

Figure 3. Trim Connections To Decrease Output Voltage Using Fixed Resistors

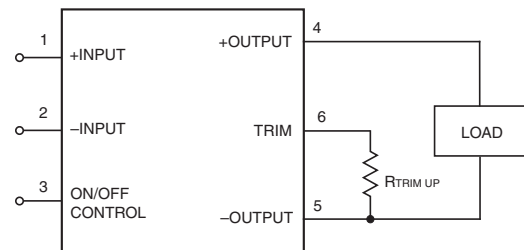

Figure 4. Trim Connections To Increase Output Voltage Using Fixed Resistors

Model	Trim Equation
UEP-3.3/4500-D12	$R_{T_{DOWN}} (k\Omega) = \frac{2.49(V_O - 1.27)}{3.3 - V_O} - 16.9$
UEP-3.3/4500-D24	
UEP-3.3/4500-D48	
UEP-3.3/6000-D48	$R_{T_{UP}} (k\Omega) = \frac{3.16}{V_O - 3.3} - 16.9$
UEP-5/3500-D12	$R_{T_{DOWN}} (k\Omega) = \frac{2.49(V_O - 2.527)}{5 - V_O} - 15$
UEP-5/3500-D24	
UEP-5/3500-D48	
UEP-5/6000-D48	$R_{T_{UP}} (k\Omega) = \frac{6.292}{V_O - 5} - 15$
UEP-12/1400-D12	$R_{T_{DOWN}} (k\Omega) = \frac{6.34(V_O - 5.714)}{12 - V_O} - 49.9$
UEP-12/1400-D24	
UEP-12/1400-D48	
UEP-15/1200-D12	$R_{T_{DOWN}} (k\Omega) = \frac{7.87(V_O - 7.136)}{15 - V_O} - 63.4$
UEP-15/1200-D24	
UEP-15/1200-D48	
	$R_{T_{UP}} (k\Omega) = \frac{56.16}{V_O - 15} - 63.4$

Accuracy of adjustment is subject to tolerances of resistor values and factory-adjusted output accuracy. V_O = desired output voltage.

Input Overvoltage/Undervoltage Shutdown and Start-Up Threshold

Under normal start-up conditions, devices will not begin to regulate until the ramping-up input voltage exceeds the Start-Up Threshold Voltage (35V for "D48" models). Once operating, devices will not turn off until the input voltage drops below the Undervoltage Shutdown limit (34V for "D48" models). Subsequent re-start will not occur until the input is brought back up to the Start-Up Threshold. This built in hysteresis prevents any unstable on/off situations from occurring at a single input voltage.

Input voltages exceeding the input overvoltage shutdown specification listed in the Performance/Functional Specifications will cause the device to shutdown. A built-in hysteresis of 0.6 to 1.6 Volts for all models will not allow the converter to restart until the input voltage is sufficiently reduced.

The two 6 Amp models do not feature overvoltage shutdown and withstand surges to 100V without shutting down. For custom overvoltage protection, contact DATEL.

Input Reverse-Polarity Protection

If the input-voltage polarity is accidentally reversed, an internal diode will become forward biased and likely draw excessive current from the power source. If the source is not current limited (<10A) nor the circuit appropriately fused, it could cause permanent damage to the converter.

On/Off Control

The input-side, remote On/Off Control function (pin 3) can be ordered to operate with either polarity (negative polarity available for 12 and 15 Volt models only). Positive-polarity devices (standard, no part-number suffix) are enabled when pin 3 is left open or is pulled high (+13V to V_{IN} applied with respect to -Input, pin 2, (see Figure 2). Positive-polarity devices are disabled when pin 3 is pulled low (0-0.8V with respect to -Input). Negative-polarity devices are off when pin 3 is open or pulled high (+2.4V to +10V), and on when pin 3 is pulled low (0-0.5V). See Figure 3.

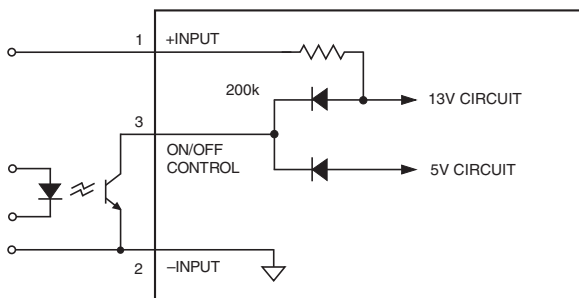

Figure 2. Driving the Positive Polarity On/Off Control Pin

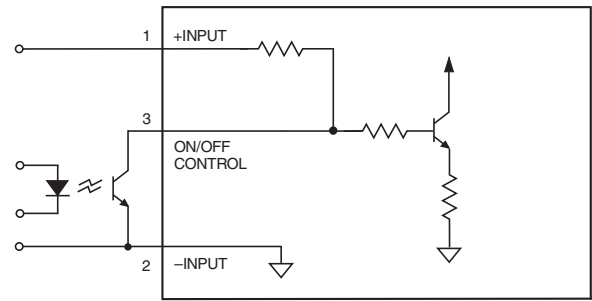

Figure 3. Driving the Negative Polarity On/Off Control Pin

Dynamic control of the remote on/off function is best accomplished with a mechanical relay or an open-collector/open-drain drive circuit (optically isolated if appropriate). The drive circuit should be able to sink appropriate current (see Performance Specs) when activated and withstand appropriate voltage when deactivated.

Applying an external voltage to pin 3 when no input power is applied to the converter can cause permanent damage to the converter.

Start-Up Time

The V_{IN} to V_{OUT} start-up time is the interval of time where the input voltage crosses the turn-on threshold point, and the fully loaded output voltage enters and remains within its specified accuracy band. Actual measured times will vary with input source impedance, external input/output capacitance, and load. The UEP Series implements a soft start circuit that limits the duty cycle of the PWM controller at power up, thereby limiting the Input Inrush current.

The On/Off Control to V_{OUT} start-up time assumes the converter has its nominal input voltage applied but is turned off via the On/Off Control pin. The specification defines the interval between the time at which the converter is turned on and the fully loaded output voltage enters and remains within its specified accuracy band. Similar to the V_{IN} to V_{OUT} start-up, the On/Off Control to V_{OUT} start-up time is also governed by the internal soft start circuitry and external load capacitance.

Current Limiting

When output increases to 120% to 190% of the rated output current, the DC/DC converter will go into a current limiting mode. In this condition the output voltage will decrease proportionately with increases in output current, thereby maintaining a somewhat constant power dissipation. This is commonly referred to as power limiting. Current limit inception is defined as the point where the full-power output voltage falls below the specified tolerance. See Performance/Functional Specifications. If the load current being drawn from the converter is significant enough, the unit will go into a short circuit condition. See "Short Circuit Condition."

Short Circuit Condition

When a converter is in current limit mode the output voltages will drop as the output current demand increases. If the output voltage drops too low, the magnetically coupled primary side voltages will also drop, thereby shutting down the PWM controller.

Following a time-out period, the PWM will restart, causing the output voltage to begin ramping to its appropriate value. If the short-circuit condition persists, another shutdown cycle will be initiated. This on/off cycling is referred to as "hiccup" mode. The hiccup cycling reduces the average output current, thereby preventing internal temperatures from rising to excessive levels. The UEP is capable of enduring an indefinite short circuit output condition.

Thermal Shutdown

These UEP converters are equipped with Thermal Shutdown Circuitry. If environmental conditions cause the internal temperature of the DC/DC converter rises above the designed operating temperature (typically 118°C case), a precision temperature sensor will power down the unit. When the internal temperature decreases below the threshold of the temperature sensor the unit will self start.

Output Overvoltage Protection

Output voltages are monitored for an overvoltage condition via magnetic coupling to the primary side. If the output voltage should rise to a level which could be damaging to the load circuitry, the sensing circuitry will power down the PWM controller causing the output voltages to decrease. Following a time-out period the PWM will restart, causing the output voltages to ramp to their appropriate values. If the fault condition persists, and the output voltage again climbs to excessive levels, the overvoltage circuitry will initiate another shutdown cycle. This on/off cycling is referred to as "hiccup" mode.

Soldering Guidelines

Murata Power Solutions recommends the specifications below when installing these converters. These specifications vary depending on the solder type. Exceeding these specifications may cause damage to the product. Be cautious when there is high atmospheric humidity. We strongly recommend a mild pre-bake (100° C. for 30 minutes). Your production environment may differ; therefore please thoroughly review these guidelines with your process engineers.

Wave Solder Operations for through-hole mounted products (THMT)

For Sn/Ag/Cu based solders:

Maximum Preheat Temperature	115° C.
Maximum Pot Temperature	270° C.
Maximum Solder Dwell Time	7 seconds

For Sn/Pb based solders:

Maximum Preheat Temperature	105° C.
Maximum Pot Temperature	250° C.
Maximum Solder Dwell Time	6 seconds

Typical Performance Curves

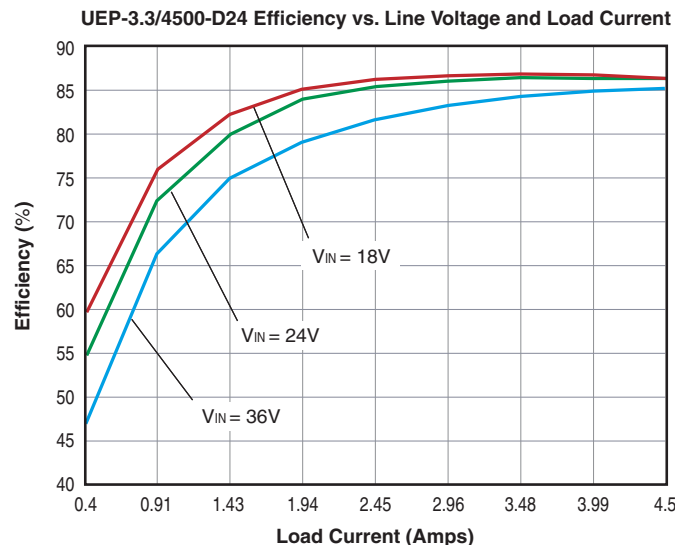
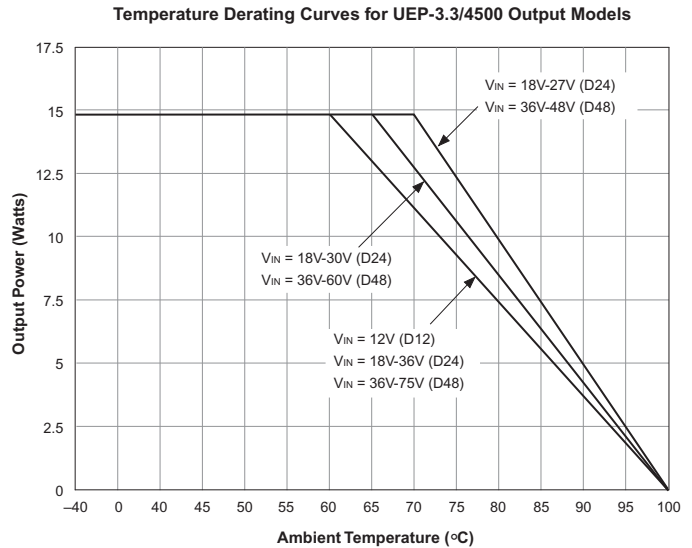

Typical Performance Curves

Temperature Derating Curves for UEP-3.3/6000-D48

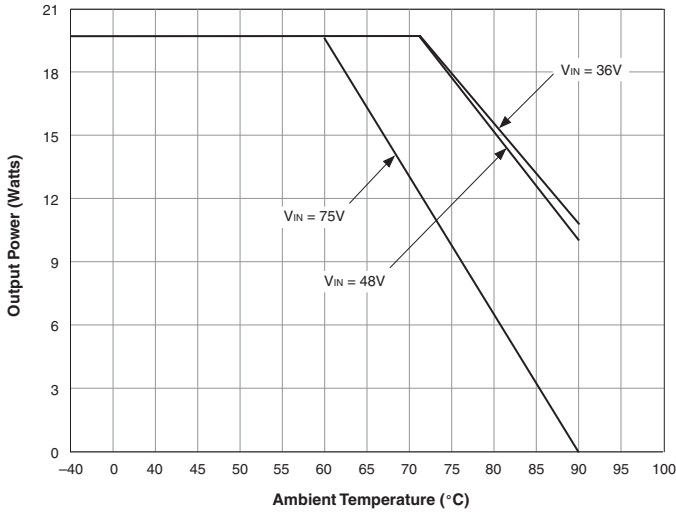

UEP-3.3/4500-D48 Efficiency vs. Line Voltage and Load Current

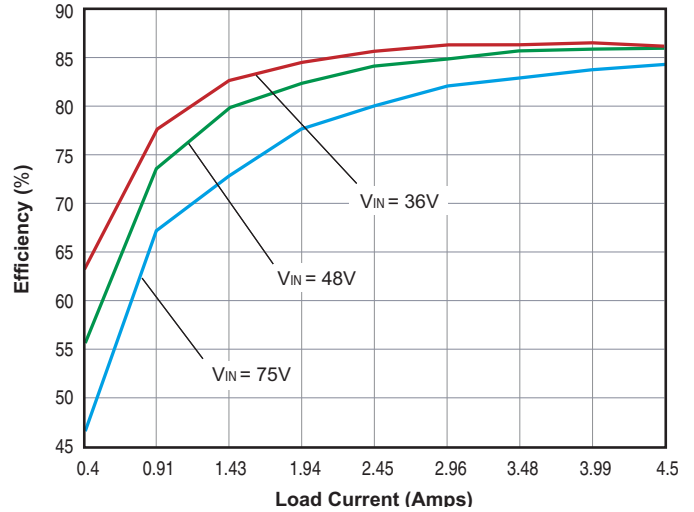

UEP-3.3/4500-D12 Efficiency vs. Line Voltage and Load Current

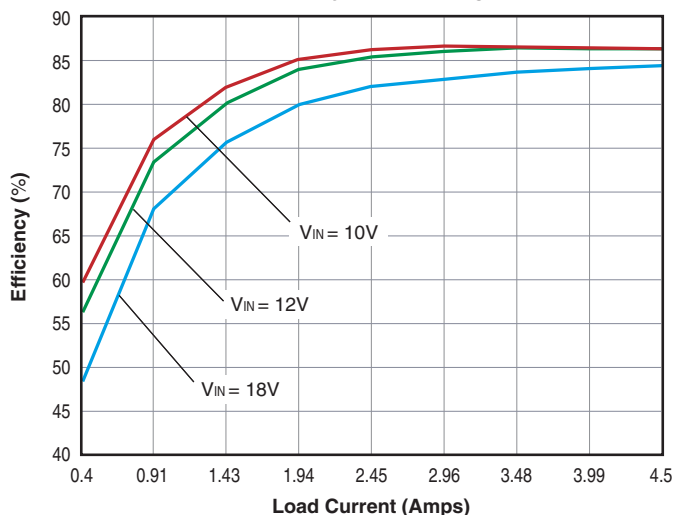

UEP-3.3/6000-D48 Efficiency vs. Line Voltage and Load Current

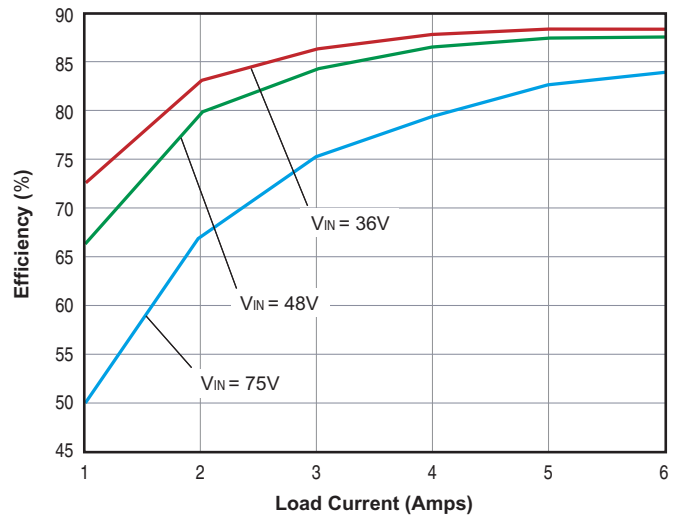

Typical Performance Curves

Temperature Derating Curves for UEP-5/3500 Output Models

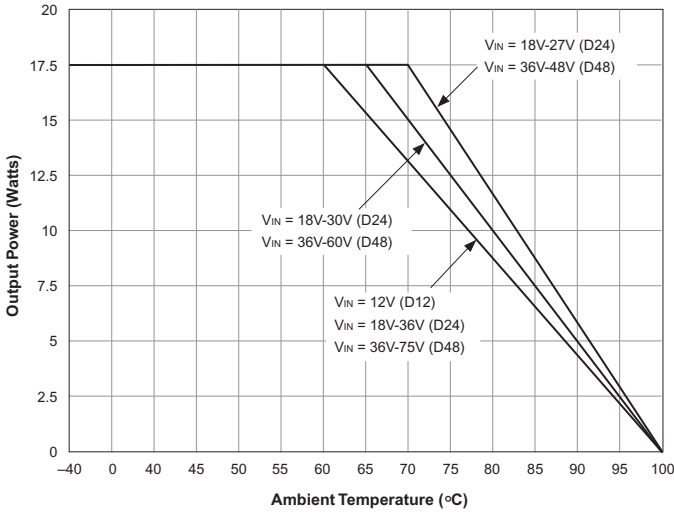

Temperature Derating Curves for UEP-5/6000-D48

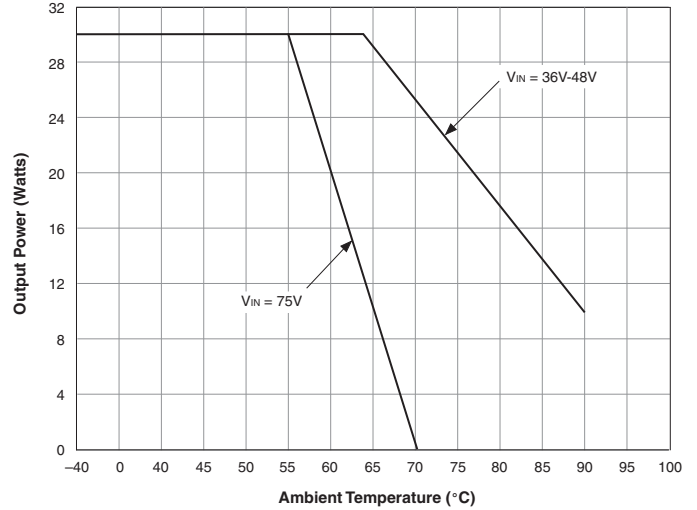

UEP-5/3500-D24 Efficiency vs. Line Voltage and Load Current

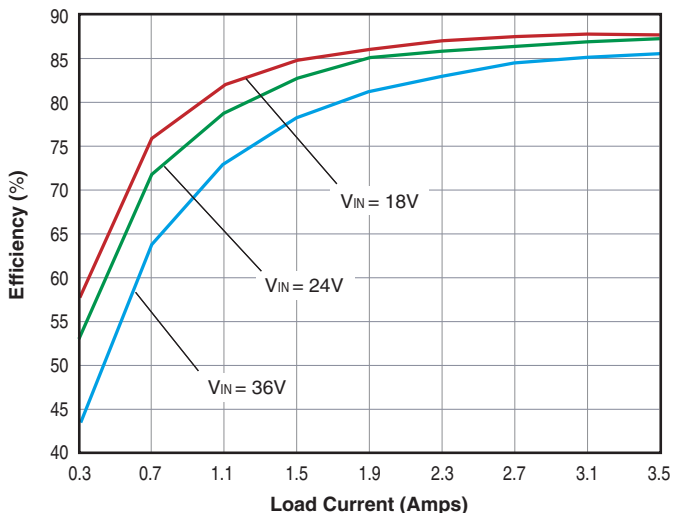

UEP-5/3500-D12 Efficiency vs. Line Voltage and Load Current

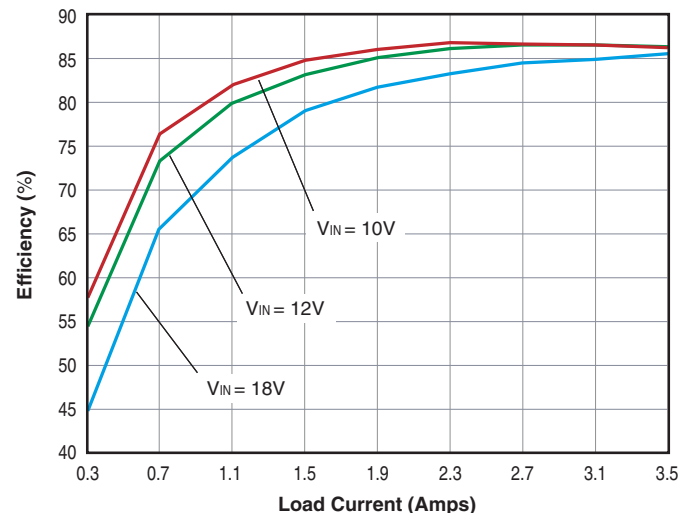

Typical Performance Curves

UEP-5/3500-D48 Efficiency vs. Line Voltage and Load Current

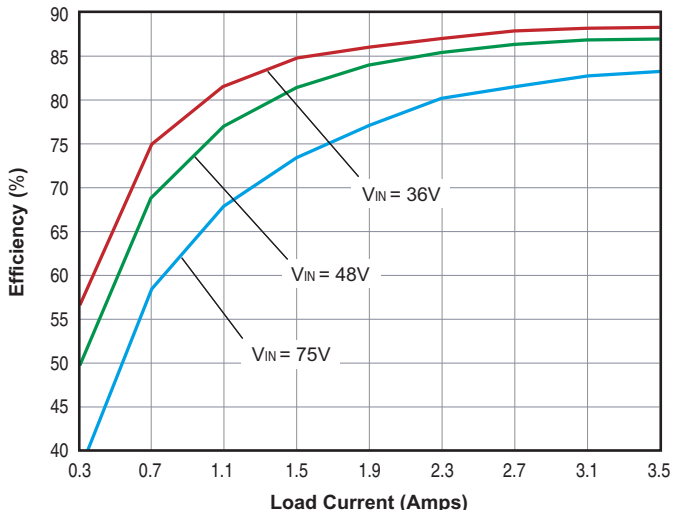

Temperature Derating Curves for 12V Output Models

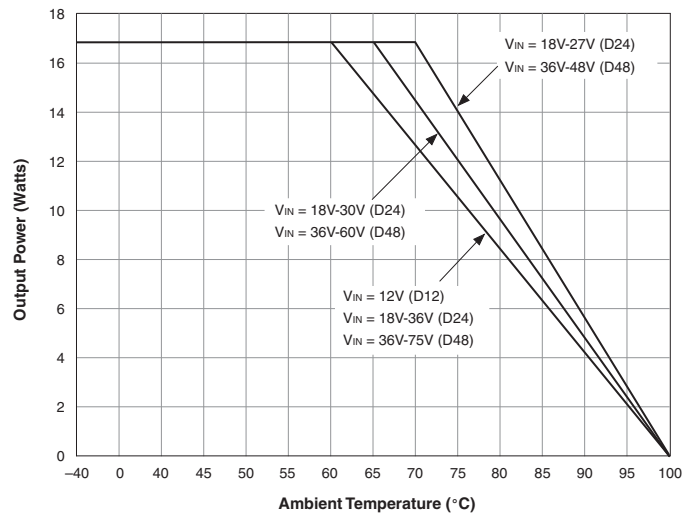

UEP-5/6000-D48 Efficiency vs. Line Voltage and Load Current

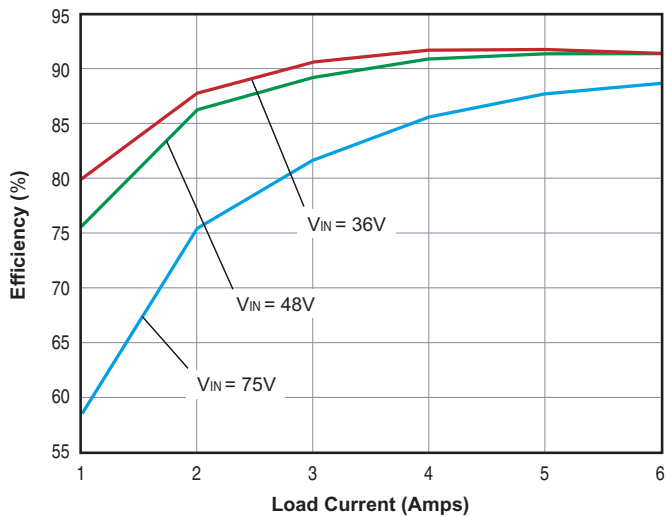

UEP-12/1400-D24 Efficiency vs. Line Voltage and Load Current

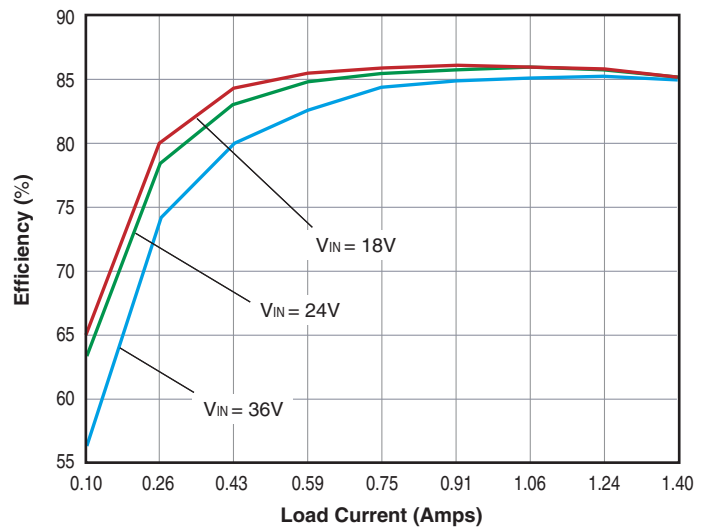

Typical Performance Curves

UEP-12/1400-D12 Efficiency vs. Line Voltage and Load Current

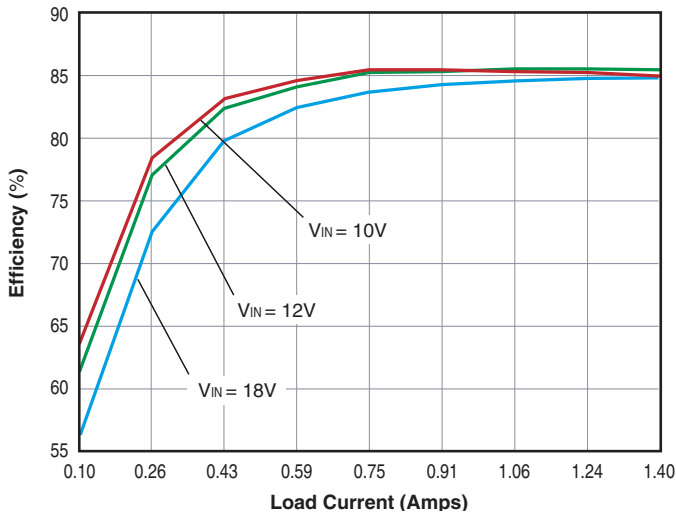

UEP-15/1200-D24 Efficiency vs. Line Voltage and Load Current

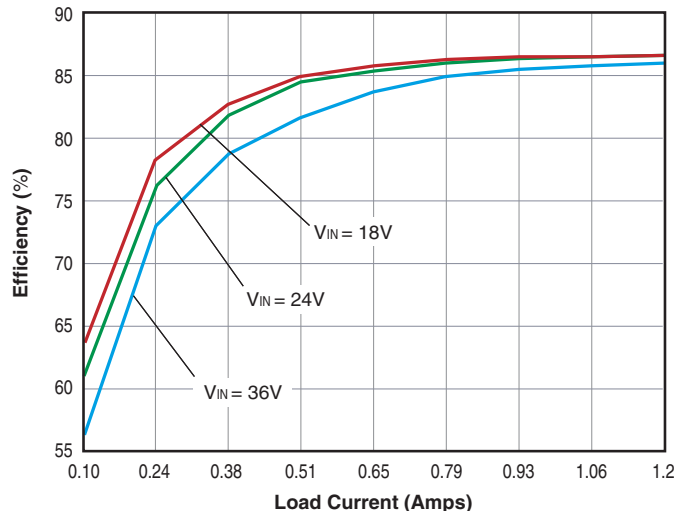

UEP-12/1400-D48 Efficiency vs. Line Voltage and Load Current

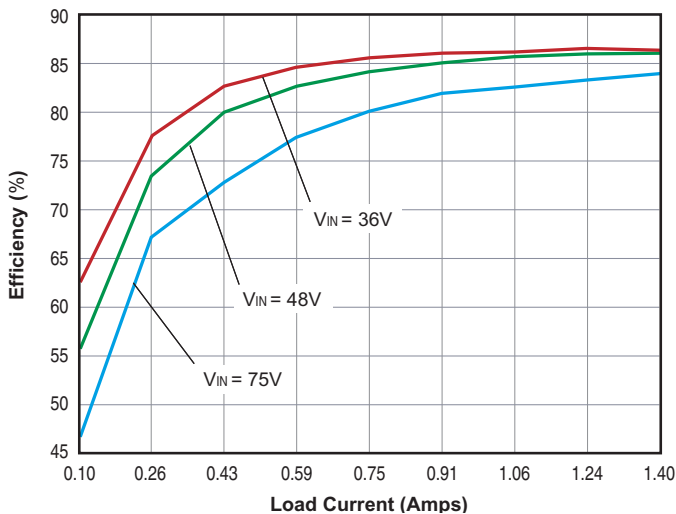

UEP-15/1200-D12 Efficiency vs. Line Voltage and Load Current

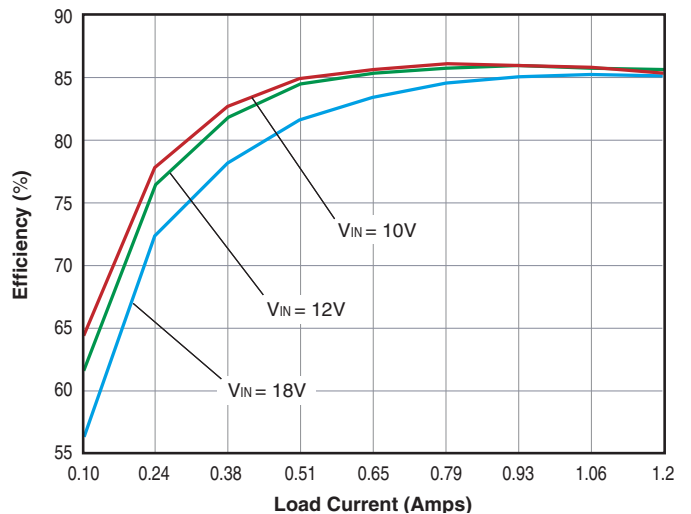

Temperature Derating Curves for 15V Output Models

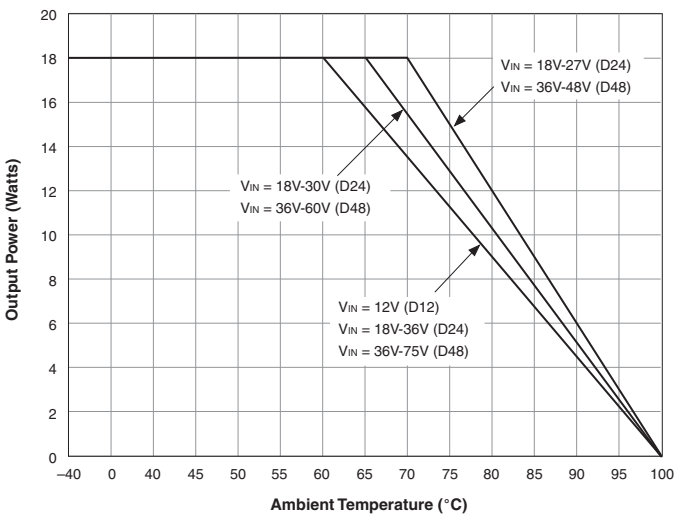

UEP-15/1200-D48 Efficiency vs. Line Voltage and Load Current

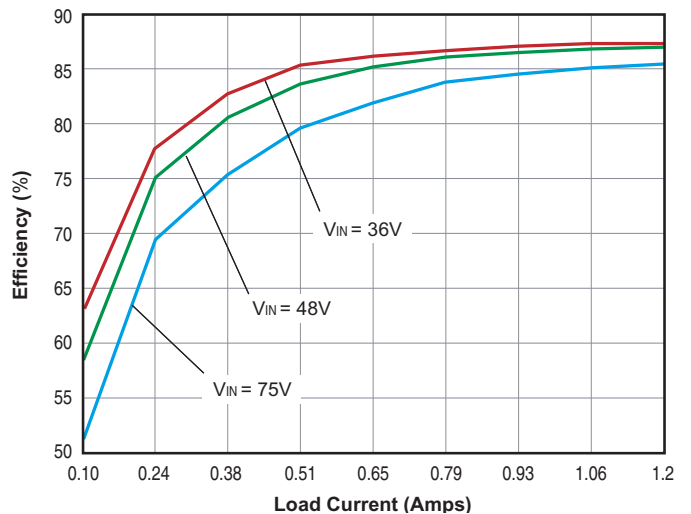

Typical Performance Curves

Output Ripple and Noise (PARD)

(VIN = nominal, 3.3V @ 4.5A, no external capacitors.)

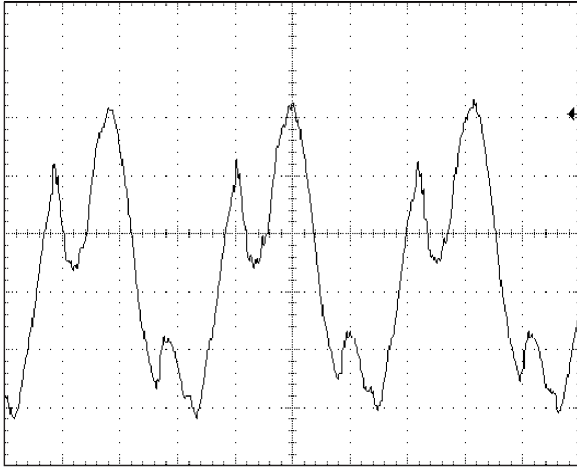

20mV/div, 20MHz BW

Output Ripple and Noise (PARD)

(VIN = nominal, 12V @ 1.4A, no external capacitors.)

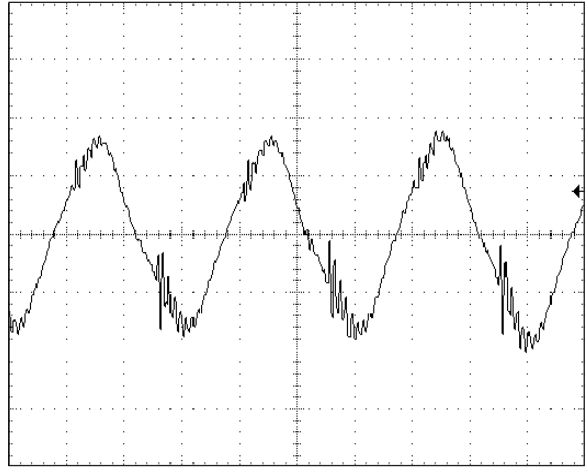

Output Ripple and Noise (PARD)

(VIN = nominal, 15V @ 1.2A, no external capacitors.)

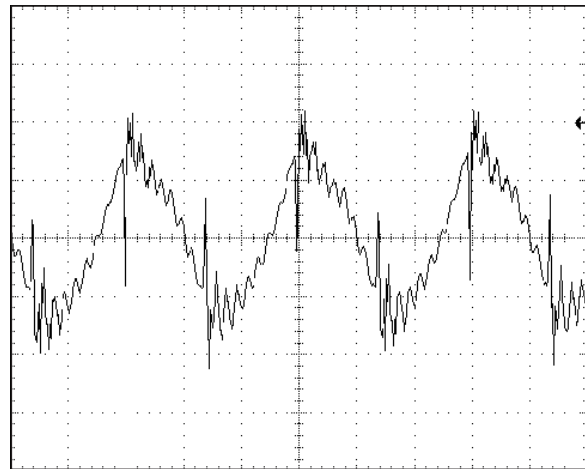

20mV/div, 20MHz BW

Output Ripple and Noise (PARD)

(VIN = nominal, 5V @ 3.5A, no external capacitors.)

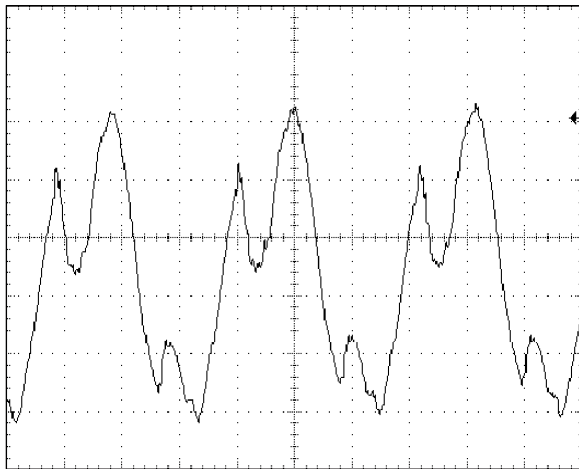

20mV/div, 20MHz BW