



Features

- Higher operating temperatures
- Fully potted
- Designed to meet UL 60950-1 and EN60950-1 (basic insulation)
-  mark available (75V-input models)
- Fully isolated, 1500Vdc guaranteed
- 25/30/35/40W output power
- Standard pinout! Smaller size!
- 2" x 3" package fits 3" x 3" footprint
- +5V and ±12V or +5V and ±15V outputs
- Four input voltage ranges:
10-36V, 18-36V, 18-75V, 36-75V
- High efficiencies (to 86%)
- V_{out} trim and on/off control
- Modifications and customs for OEM's

DATEL's TMP Models are fully potted, 25-40 Watt, triple-output DC/DC converters designed to meet UL 60950-1 and EN60950-1 safety standards. The TMP's higher efficiencies and thermally conductive potting compound enable these devices to achieve higher operating temperatures without derating. The 2" x 3" TMP "footprint" conforms to the standard pinout and pin geometries of most 3" x 3" devices (a 33% space savings) while delivering 60% more power (40W vs. 25W).

Applicable to a wide range of telecom, computer and other OEM applications, TMP Model DC/DC's offer +5V and ±12V or +5V and ±15V outputs. They operate from four different input voltage ranges with total available output power being a function of the selected range. "Q12" models operate from 10-36V and deliver 25W. "Q48" models operate from 18-75V and deliver 30W. For "D24" and "D48" models, the input ranges and output powers are 18-36V at 35W and 36-75V at 40W, respectively.

TMP's employ corrosion-resistant metal cases with plastic headers. Heat-generating transformer cores and power semiconductors are mounted to the cases, which have threaded inserts for add-on heat sinks.

All devices feature input pi filters, input overvoltage shutdown, output overvoltage protection, output current limiting, and thermal shutdown.

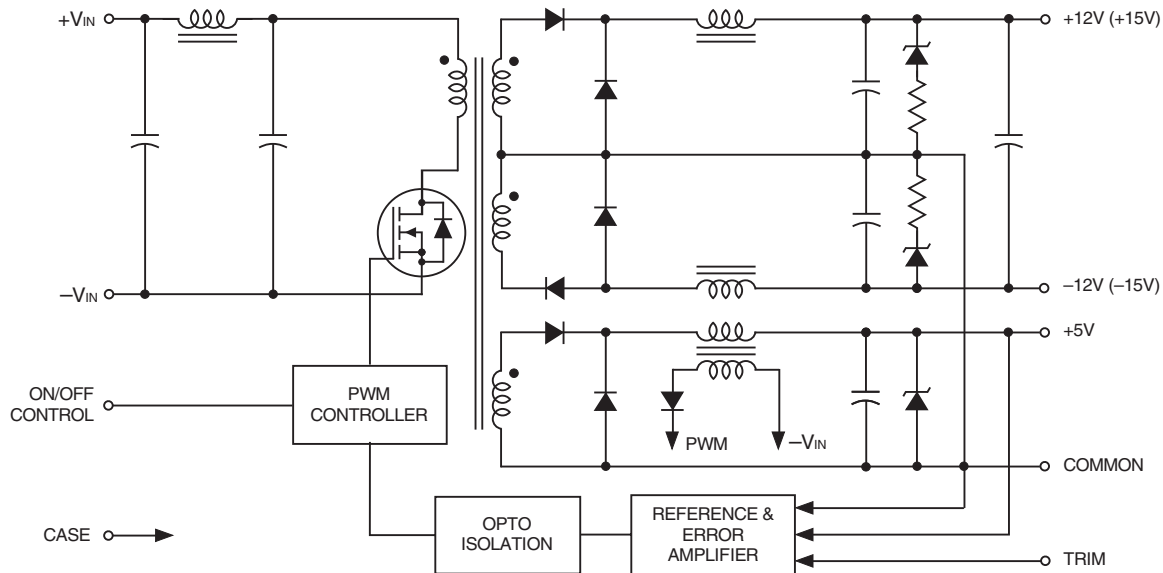

Figure 1. Simplified Schematic



Typical topology is shown

Performance Specifications and Ordering Guide ^①

Model	V _{OUT} (Volts)	I _{OUT} (Amps)	Output		Regulation (Max.)		V _{IN} Nom. (Volts)	Range (Volts)	I _{IN} ^④ (mA)	Efficiency		Package (Case, Pinout)	
			R/N (mVp-p) ^②	Typ.	Max.	Line				Load ^③	Min.		Typ.
TMP-5/5-12/1-Q12-C	+5	5	75	100	±1%	±1.5%	24	10-36	35/1240	82%	84%	C11, P16	
	±12	±1	100	120	±1.5%	±8%							
TMP-5/5-12/1-D24-C	+5	5	75	100	±1%	±1.5%	24	18-36	35/1716	83%	85%	C11, P16	
	±12	±1	100	120	±1.5%	±8%							
TMP-5/5-12/1-Q48-C	+5	5	75	100	±1%	±1.5%	48	18-75	20/727	83%	86%	C11, P16	
	±12	±1	100	120	±1.5%	±8%							
TMP-5/5-12/1-D48-C	+5	5	75	100	±1%	±1.5%	48	36-75	25/969	83%	86%	C11, P16	
	±12	±1	100	120	±1.5%	±8%							
TMP-5/5-15/1-Q12-C	+5	5	75	100	±1%	±1.5%	24	10-36	35/1238	82%	85%	C11, P16	
	±15	±1	100	150	±1.5%	±8%							
TMP-5/5-15/1-D24-C	+5	5	75	100	±1%	±1.5%	24	18-36	35/1696	83.5%	86%	C11, P16	
	±15	±1	100	150	±1.5%	±8%							
TMP-5/5-15/1-Q48-C	+5	5	75	100	±1%	±1.5%	48	18-75	20/735	82%	85%	C11, P16	
	±15	±1	100	150	±1.5%	±8%							
TMP-5/5-15/1-D48-C	+5	5	75	100	±1%	±1.5%	48	36-75	25/981	83%	85%	C11, P16	
	±15	±1	120	150	±1.5%	±8%							

① Typical at T_A = +25°C under nominal line voltage and "full-load" conditions unless otherwise noted. The specific combination of primary and auxiliary currents comprising "full load" varies with part number. See Output Power Considerations and Technical Notes for more details.

② Ripple/Noise (R/N) measured over a 20MHz bandwidth.

③ 10-100% load on the primary +5V output, 20-100% balanced loads on the auxiliary outputs.

④ Nominal line voltage, no-load/full-load conditions.

PART NUMBER STRUCTURE

TMP-5 / 5-12 / 1-D48-C

Output Configuration:
T = Triple

Fully Potted Metal Package

Nominal Primary Output
Voltage (+5 Volts)

Maximum Primary Output
Current in Amps

Nominal Auxiliary Output
Voltages (±12 or ±15 Volts)

RoHS Compliant

Input Voltage Range:

Q12 = 10-36 Volts (24V nom.)

D24 = 18-36 Volts (24V nom.)

Q48 = 18-75 Volts (48V nom.)

D48 = 36-75 Volts (48V nom.)

Maximum Auxiliary Output

Currents in Amps from each output
Some model number combinations may not be available. Please contact Murata Power Solutions.

OUTPUT POWER CONSIDERATIONS

As shown below, TMP Model DC/DC Converters are classified by output power. For triple-output devices, the sum of the output power from the primary +5V output and the two auxiliary (±12V or ±15V) outputs can not exceed the rated power. For example, "D24" models have a maximum power of 35W. Therefore, if you source the maximum primary current of 5A, the devices will only be able to provide 10W of total power from their auxiliary outputs.

Model	Maximum Output Power
Q12	25 Watts
Q48	30 Watts
D24	35 Watts
D48	40 Watts

MECHANICAL SPECIFICATIONS

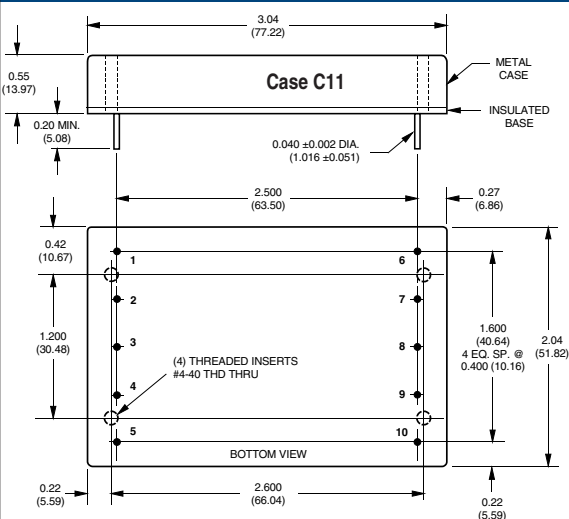

I/O Connections

Pin	Function P16
1	No Pin
2	-Input
3	+Input
4	Case
5	On/Off Control*
6	-12V/15V Out
7	+12V/15V Out
8	Common
9	+5V Out
10	Trim

* See note 4 on next page.

Dimensions are in inches (mm shown for ref. only).

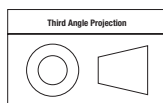

Tolerances (unless otherwise specified):
.XX ± 0.02 (0.5)
.XXX ± 0.010 (0.25)
Angles = 2°

Components are shown for reference only.

Optional Heat Sink Kit (Part Number HS-23 <non-RoHS> or HS-23-C <RoHS>)

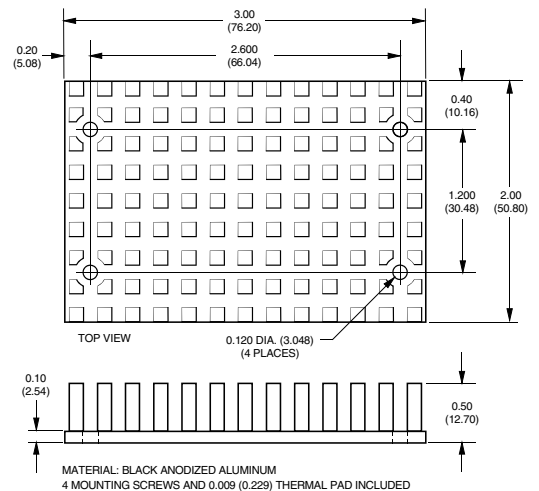

Performance/Functional Specifications

Typical @ TA = +25°C under nominal line voltage and "full-load" conditions, unless noted. ① ②

INPUT	
Input Voltage Range:	
Q12 Models	10-36 Volts (24V nominal)
D24 Models	18-36 Volts (24V nominal)
Q48 Models	18-75 Volts (48V nominal)
D48 Models	36-75 Volts (48V nominal)
Input Current	See Ordering Guide
Input Filter Type	Pi
Overvoltage Shutdown:	
Q12 and D24 Models	40 Volts
Q48 and D48 Models	80 Volts
Reverse-Polarity Protection	Yes (Instantaneous, 6A maximum)
On/Off Control (Pin 5) ③	Pin open = ON, (logic HI) Pin grounded = OFF (logic LO)
Output	
V_{out} Accuracy (50% load):	
+5V Output	±1%
±12V or ±15V Outputs	±3%
Temperature Coefficient	±0.02% per °C
Ripple/Noise (20MHz BW)	See Ordering Guide
Line/Load Regulation	See Ordering Guide
Efficiency	See Ordering Guide
Isolation Voltage ④	1500Vdc, minimum
Isolation Capacitance	500pF
Current Limiting	Continuous, auto-recovery
Overvoltage Protection	Zener/transorb clamps, magnetic fdbk.
Dynamic Characteristics	
Transient Response (50% load step)	300µsec max. to ±3% of final value
Switching Frequency	125kHz (±10%)
Environmental	
Operating Temperature (ambient):	
Without Derating	-40 to +70°C (Model dependent)
With Derating	to +95°C
Maximum Case Temperature	+95°C
Storage Temperature	-40 to +105°C
Relative Humidity	To +85°C / 85% RH, non-condensing
Physical	
Safety	UL/cUL/EN/IEC 60950-1
Dimensions	2.04" x 3.04" x 0.55" (51.8 x 77.2 x 14mm)
Shielding	5-sided
Case Connection	Pin 4
Case Material	Aluminum, black anodized finish with plastic header
Flammability Rating	UL94V-0
Pin Material	Gold-plated copper alloy over nickel underplate
Weight	6 ounces (170 grams)

① These converters require a minimum 10% loading on their primary output and 20% loading on each auxiliary output to maintain specified regulation. Operation under no-load conditions will not damage these devices; however they may not meet all listed specifications.

② "Full load" varies by part number and is determined by the input voltage range as indicated by the part number suffix. See Technical Notes and Output Power Considerations.

- ③ Applying a voltage to the On/Off Control pin when no input power is applied to the converter can cause permanent damage to the converter.
- ④ Listed specification is for input-to-output isolation. Input-to-case and output-to-case isolation is 1000Vdc, minimum.

Absolute Maximum Ratings

Input Voltage:	
Q12/D24 Models	44 Volts
Q48/D48 Models	88 Volts
Input Reverse-Polarity Protection	Current must be <6A. Brief duration only. Fusing recommended.
Output Overvoltage Protection	
+5V Output	6.8 Volts, limited duration
±12V Outputs	15 Volts, limited duration
±15V Outputs	18 Volts, limited duration
Output Current	Current limited. Max. current and short-circuit duration are model dependent.
Storage Temperature	-40 to +105°C

These are stress ratings. Exposure of devices to any of these conditions may adversely affect long-term reliability. Proper operation under conditions other than those listed in the Performance/Functional Specifications Table is not implied.

TECHNICAL NOTES

Filtering and Noise Reduction

All TMP 25-40 Watt DC/DC Converters achieve their rated ripple and noise specifications without the use of external input/output capacitors. In critical applications, input/output ripple and noise may be further reduced by installing electrolytic capacitors across the input terminals and/or low-ESR tantalum or electrolytic capacitors across the output terminals. Output capacitors should be connected between their respective output pin (pin 6, 7 or 9) and Common (pin 8). The caps should be located as close to the power converters as possible. See Figure 7. Typical values are listed in the tables below. In many applications, using values greater than those listed will yield better results.

To Reduce Input Ripple

Q12, D24 Models	47µF, 50V
Q48, D48 Models	10µF, 100V

To Reduce Output Ripple

+5V Output	47µF, 10V, Low ESR
±12/15V Outputs	22µF, 20V, Low ESR

In critical, space-sensitive applications, DATEL may be able to tailor the internal input/output filtering of these units to meet your specific requirements. Contact our Applications Engineering Group for additional details.

Input Fusing

Certain applications and/or safety agencies may require the installation of fuses at the inputs of power conversion components. For DATEL TMP DC/DC Converters, you should use slow-blow type fuses with values no greater than the following:

V _{IN} Range	Fuse Value
Q12	4A
D24	4A
Q48	3A
D48	2A

Temperature Derating and Electrical Performance Curves

Q12 Models (25 Watts)

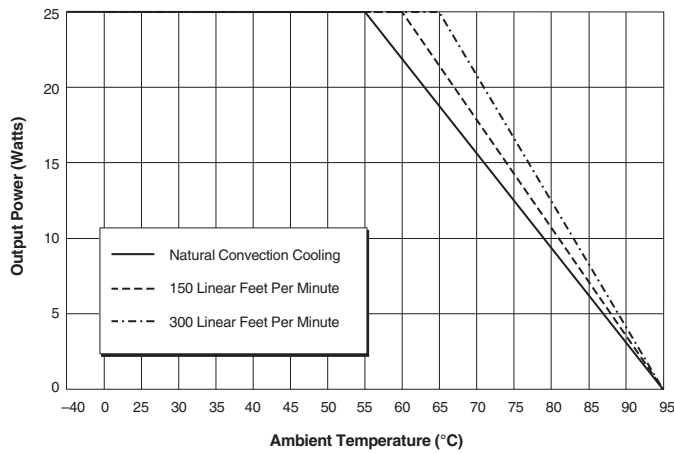

Figure 2a. Temperature Derating Without Heat Sink

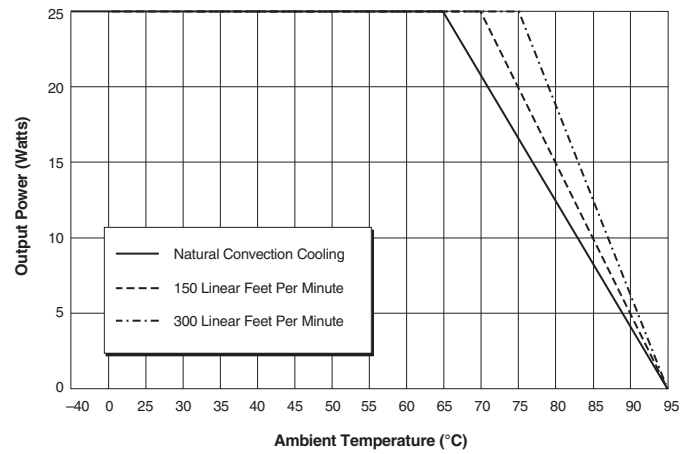

Figure 2b. Temperature Derating With Heat Sink

Q48 Models (30 Watts)

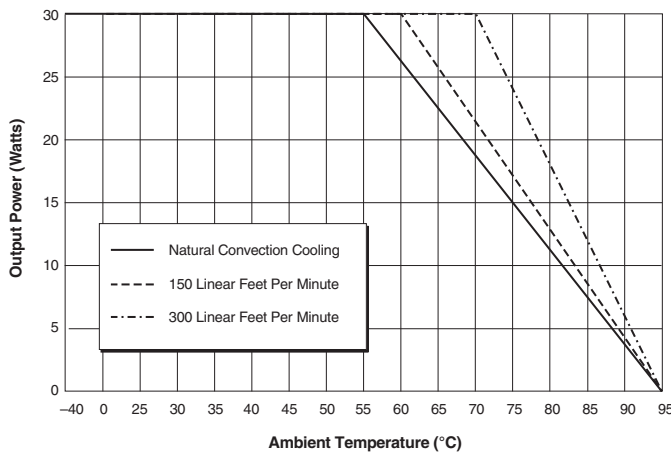

Figure 3a. Temperature Derating Without Heat Sink

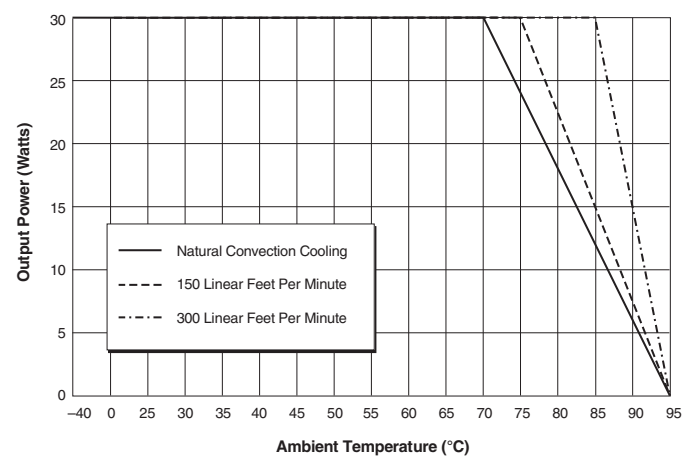

Figure 3b. Temperature Derating With Heat Sink

D24 Models (35 Watts)

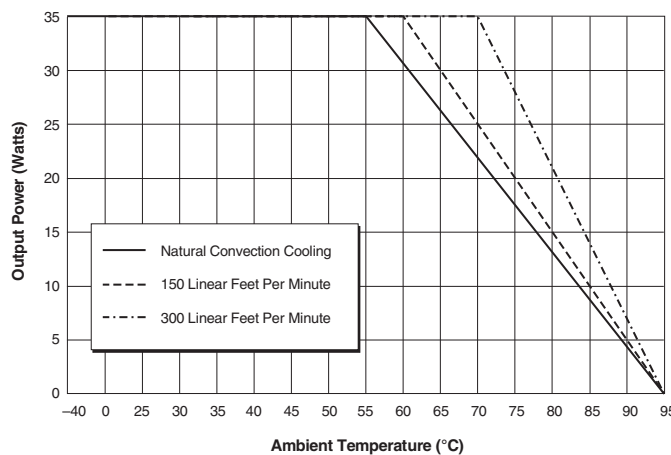

Figure 4a. Temperature Derating Without Heat Sink

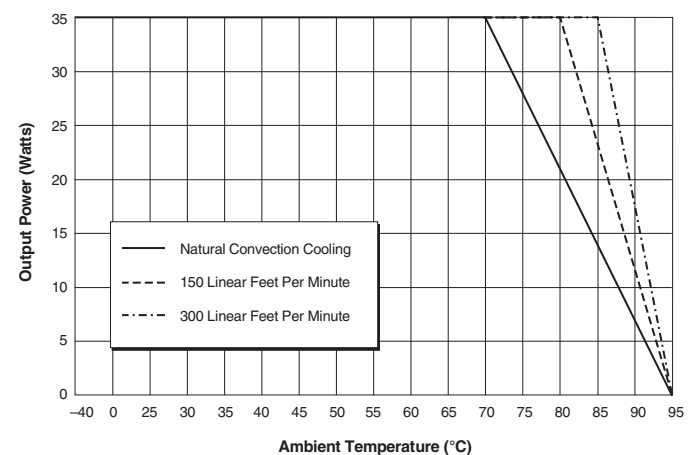

Figure 4b. Temperature Derating With Heat Sink

Temperature Derating and Electrical Performance Curves

D48 Models (40 Watts)

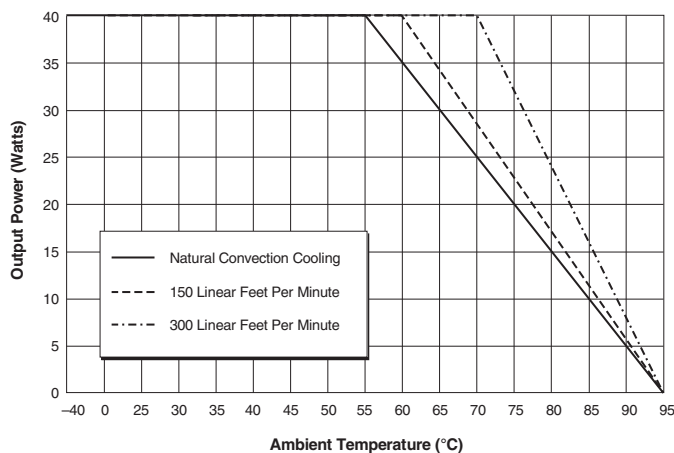

Figure 5a. Temperature Derating Without Heat Sink

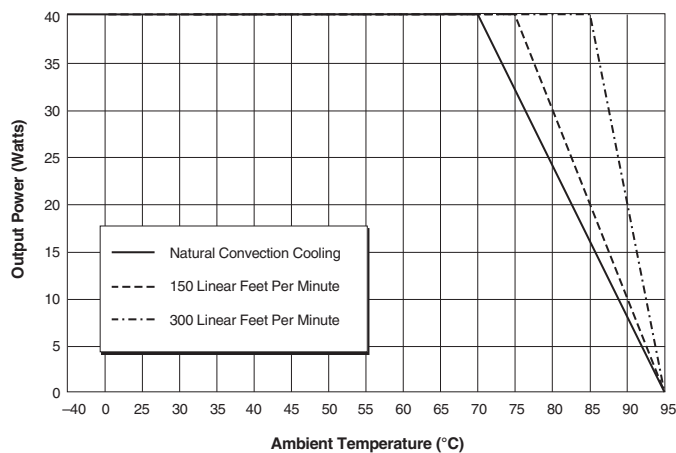

Figure 5b. Temperature Derating With Heat Sink

Output Power

TMP Model, triple-output DC/DC converters incorporate a design tradeoff between total available output power and input voltage range. The total available power is a function of both the nominal input voltage and the "width" of the input voltage range. For a given nominal input (24V or 48V), narrower ranges (2:1 vs. 4:1) have more available power. For a given "width" of input range (2:1 or 4:1), higher nominal inputs (48V vs. 24V) have more available power. Each device, as indicated by its part-number suffix (Q12, Q48, D24, D48), has a total output power limitation of 25, 30, 35 or 40 Watts, respectively. Observing these power limitations is the user's responsibility.

As indicated by its Part Number Structure, each TMP device is capable of sourcing up to 5 Amps of +5V current as well as ±1 Amp of auxiliary (±12V

or ±15V) currents. Users have the flexibility of loading any output up to these limits; however, you must be extremely careful not to exceed the total output power rating of any given device. If, for example, a device with a 30W power rating is sourcing 4A from its +5V output (representing 20W of primary output power), that device can only supply an additional 10W from its auxiliary outputs (±333mA from ±15V outputs or ±417mA from ±12V outputs).

As a consequence of this "power-allocation" flexibility, the definition of "full load," as the condition under which performance specifications are tested and listed, is ambiguous. The following table lists the primary and auxiliary output currents that DATEL uses to define each device's "full load."

Model Number	Voltage Range	Output Power	Definition of "Full Load" for Specification Purposes		
			+5V Current	±12V Currents	±15V Currents
TMP-5/5-12/1-Q12	10-36V	25 Watts	2.6A (13W)	±500mA (12W)	–
TMP-5/5-12/1-Q48	18-75V	30 Watts	3A (15W)	±625mA (15W)	–
TMP-5/5-12/1-D24	18-36V	35 Watts	4A (20W)	±625mA (15W)	–
TMP-5/5-12/1-D48	36-75V	40 Watts	4A (20W)	±833mA (20W)	–
TMP-5/5-15/1-Q12	10-36V	25 Watts	2.5A (12.5W)	–	±417mA (12.5W)
TMP-5/5-15/1-Q48	18-75V	30 Watts	3A (15W)	–	±500mA (15W)
TMP-5/5-15/1-D24	18-36V	35 Watts	4A (20W)	–	±500mA (15W)
TMP-5/5-15/1-D48	36-75V	40 Watts	4A (20W)	–	±667mA (20W)

Table 1. Output Currents Comprising "Full Load"

On/Off Control (Standard)

The On/Off Control pin (pin 5) may be used for remote on/off operation. As shown in Figure 6, the control pin has an internal 10kΩ pull-up resistor to approximately 10V. The converter is designed so that it is enabled when the control pin is left open (normal mode) and disabled when the control pin is pulled low (to less than +0.8V relative to -Input, pin 2).

Dynamic control of the on/off function is best accomplished with a mechanical relay or an open-collector/open-drain drive circuit (optically isolated if appropriate). The drive circuit should obviously be able to sink approximately 1mA when activated and withstand more than 10 Volts when deactivated.

Applying an external voltage to pin 5 when no input power is applied to the converter can cause permanent damage to the converter. The on/off control function, however, is designed such that the converter can be disabled (pin 5 pulled low) while input power is ramping up and then "released" once the input has stabilized. Under these circumstances, it takes approximately 30ms for the output of the fully loaded DC/DC to ramp up and settle to within ±1% of its final value after the converter has been turned on.

Output Trimming

The +5V output may be trimmed ±6% via a single external trimpot or fixed resistor. The trimpot should be connected as shown in Figure 7 with its wiper connected to pin 10 (Trim). A trimpot can also be used to determine the value of a single fixed resistor which should be connected as shown in Figure 8. Connect the resistor between pin 10 (Trim) and pin 9 (+5V Output) to trim "down" the output voltage. Connect the resistor between pins 10 and 8 (Common) to trim "up" the output voltage. Fixed resistors should be metal-film types with absolute TCR's less than 100ppm/°C to ensure stability.

Case Connection

Unlike most other DC/DC converters, TMP DC/DC's do not have their metal case connected to one of their input pins. The "uncommitted" case is connected to pin 4 which, depending on your system configuration, should be connected to either +Input (pin 3) or -Input (pin 2).

Threaded Inserts and Heatsink Installation

CAUTION: Do not use the threaded inserts to bolt the converter down to a PC board. That will place unnecessary force on the mounting pins. Instead, the converter is held securely by only soldering the mounting pins.

When attaching the heat sink from above the converter, use a maximum torque of **2 inch-pounds (0.23 N-m)** on the 4-40 bolts to avoid damaging the threaded inserts. Use a tiny amount of fastener adhesive or 4-40 lockwashers to secure the bolts.

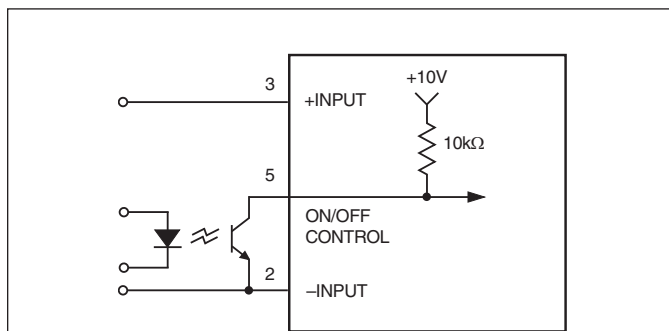

Figure 6. Driving the On/Off Control Pin

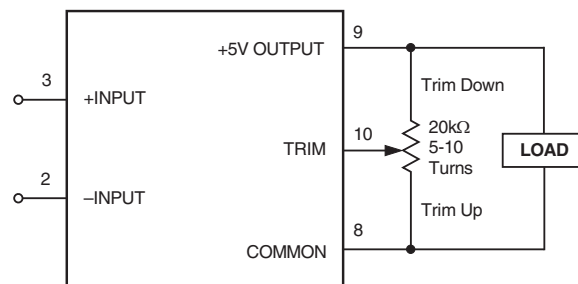

Figure 7. Trim Connections Using a Trimpot

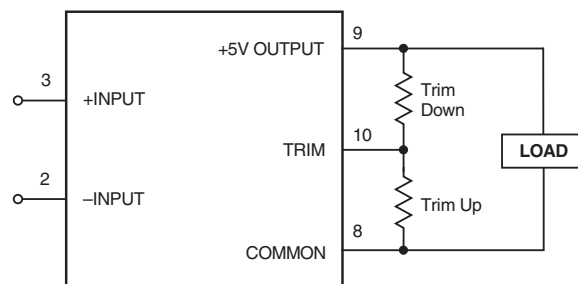

Figure 8. Trim Connections Using Fixed Resistors

Soldering Guidelines

Murata Power Solutions recommends the specifications below when installing these converters. These specifications vary depending on the solder type. Exceeding these specifications may cause damage to the product. Be cautious when there is high atmospheric humidity. We strongly recommend a mild pre-bake (100° C. for 30 minutes). Your production environment may differ therefore please thoroughly review these guidelines with your process engineers.

Wave Solder Operations for through-hole mounted products (THMT)	
For Sn/Ag/Cu based solders:	
Maximum Preheat Temperature	115° C.
Maximum Pot Temperature	270° C.
Maximum Solder Dwell Time	7 seconds
For Sn/Pb based solders:	
Maximum Preheat Temperature	105° C.
Maximum Pot Temperature	250° C.
Maximum Solder Dwell Time	6 seconds