

M3.5 x 12

DETAILS OF HOLES:
CAST AS SHOWN, DRILL
Ø3.2 ± 0.05 X 13.0 ± 0.5 DEEP

2.50

DETAIL C
SCALE 1:1

R1.60

R3.20

R1.60

R4.80

DETAIL B
SCALE 4:1

		FLANGED	
SIZE	PLAIN	POWDER COATED	NYLON COATED
C	455-0030	457-0030	458-0030
	SEALED	FLANGED	
C	456-0030	463-0030	464-0030

Tel No. +44(0)1724273200 Website www.dem-uk.com



PROPRIETARY AND CONFIDENTIAL
THE INFORMATION CONTAINED IN THIS DRAWING IS THE SOLE PROPERTY OF ALPHA 3 MANUFACTURING. ANY REPRODUCTION IN PART OR AS A WHOLE WITHOUT THE WRITTEN PERMISSION OF ALPHA 3 MANUFACTURING IS PROHIBITED.

DEM Manufacturing, Deltron Emicon House
Haggreaves Way, Sawcliffe Ind. Park,
Scunthorpe, North Lincolnshire, DN15 8PF, UK

UNLESS OTHERWISE SPECIFIED:
DIMENSIONS ARE IN MILLIMETRES
LINEAR TOLERANCE:
NO DECIMAL PLACES ±0.5mm
1 DECIMAL PLACE ±0.25mm
2 DECIMAL PLACES ±0.125mm
ANGULAR TOLERANCE: ±1°

FINISH -

DEBURR AND BREAK SHARP EDGES

IF IN DOUBT ASK
DO NOT SCALE DRAWING

MATERIAL DieCast Aluminium Alloy

DRAWN BY

APPROVED BY

BASED ANGLE PROJECTION

B.SILLENCE

B.SILLENCE

SHEET 1 OF 1

SCALE 1:1

A3

TITLE **PROCUREMENT SPECIFICATION FOR 'C' FLANGED BOX**

DRAWING NO. **C BOX FLANGED**

ISSUE **01**

Release

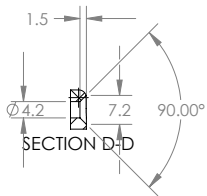
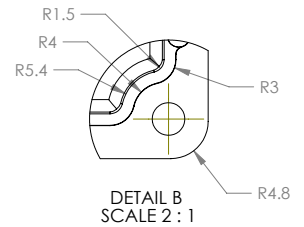
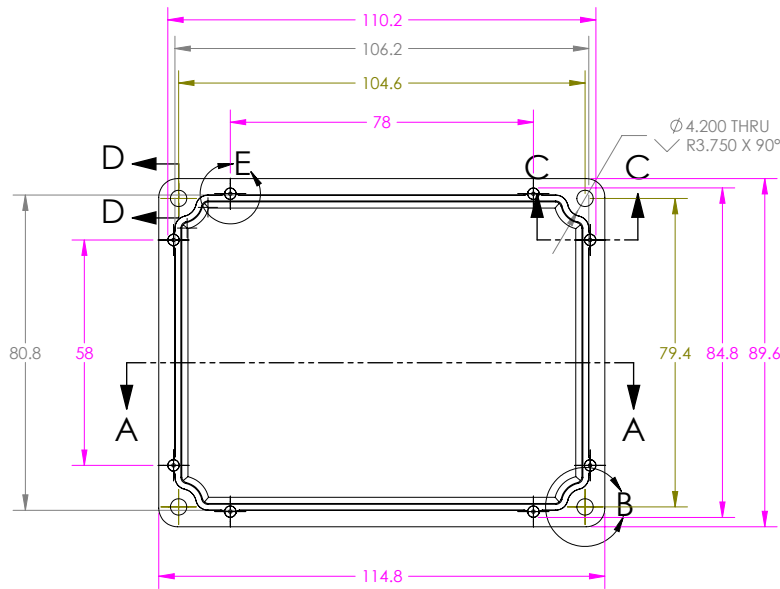
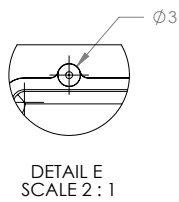
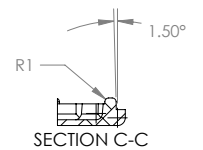
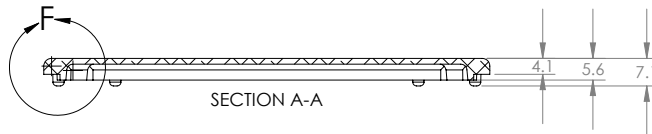
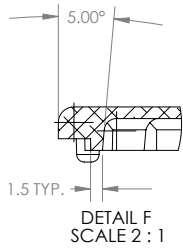

Tel No. +44(0)1724273200 Website www.dem-uk.com



PROPRIETARY AND CONFIDENTIAL
THE INFORMATION CONTAINED IN THIS DRAWING IS THE SOLE PROPERTY OF ALPHA 3 MANUFACTURING. ANY REPRODUCTION IN PART OR AS A WHOLE WITHOUT THE WRITTEN PERMISSION OF ALPHA 3 MANUFACTURING IS PROHIBITED.

DEM Manufacturing, Deltron Emicon House
Haggreaves Way, Sawcliffe Ind. Park,
Scunthorpe, North Lincolnshire, DN15 8BF, UK

UNLESS OTHERWISE SPECIFIED:
DIMENSIONS ARE IN MILLIMETRES
LINEAR TOLERANCE:
NO DECIMAL PLACES ±0.5mm
1 DECIMAL PLACE ±0.25mm
2 DECIMAL PLACES ±0.125mm
ANGULAR TOLERANCE: ±1°

FINISH -
DEBURR AND BREAK SHARP EDGES
DRAWN BY B.SILLENCE
APPROVED BY B.SILLENCE
IF IN DOUBT ASK DO NOT SCALE DRAWING
MATERIAL DieCast Aluminium Alloy

BASED ANGLE PROJECTION

B.SILLENCE
SHEET 1 OF 1
SCALE 1:1
A3

TITLE **PROCUREMENT SPECIFICATION FOR 'C' SIZE BOX LID**
DRAWING NO. C LID
ISSUE 07
Release