

Tel No. +44(0)1724273200 Website www.dem-uk.com



**PROPRIETARY AND CONFIDENTIAL**  
 THE INFORMATION CONTAINED IN THIS DRAWING IS THE SOLE PROPERTY OF ALPHA 3 MANUFACTURING. ANY REPRODUCTION IN PART OR AS A WHOLE WITHOUT THE WRITTEN PERMISSION OF ALPHA 3 MANUFACTURING IS PROHIBITED.

DEM Manufacturing, Deltron Emicon House  
 Hagreaves Way, Sawcliffe Ind. Park,  
 Scunthorpe, North Lincolnshire, DN15 8PF, UK

UNLESS OTHERWISE SPECIFIED:  
 DIMENSIONS ARE IN MILLIMETRES  
 LINEAR TOLERANCE:  
**NO DECIMAL PLACES ±0.5mm**  
**1 DECIMAL PLACE ±0.25mm**  
**2 DECIMAL PLACES ±0.125mm**  
 ANGULAR TOLERANCE: ±1°

FINISH -  
 DEBURR AND BREAK SHARP EDGES  
 IF IN DOUBT ASK  
 DO NOT SCALE DRAWING  
 MATERIAL DieCaste Aluminium Alloy

DRAWN BY  
 APPROVED BY  
 THIRD ANGLE PROJECTION

B.SILLENCE  
 SHEET 1 OF 1  
 SCALE 1:1  
 A3

**PROCUREMENT SPECIFICATION FOR 'D' SIZE FLANGED BOX**  
 DRAWING NO. D BOX FLANGED  
 ISSUE 01  
 Release

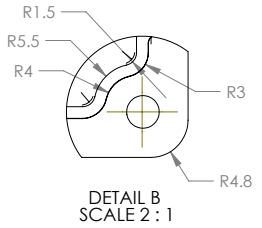
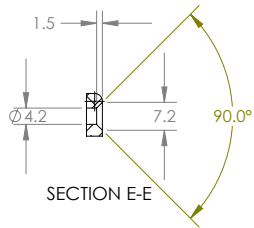
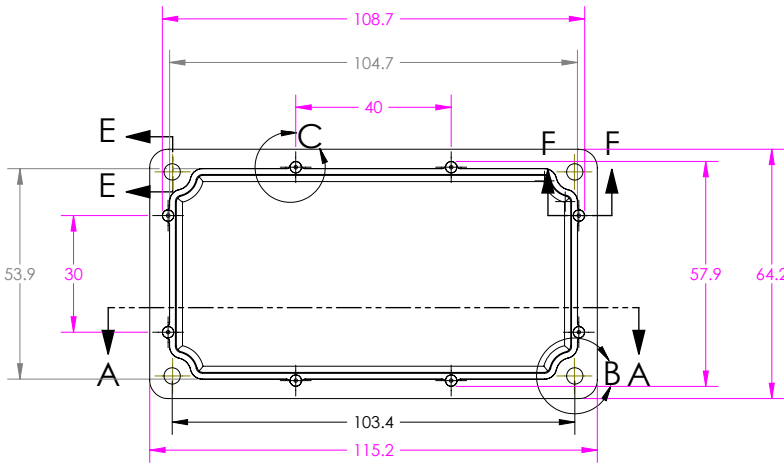
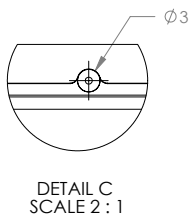
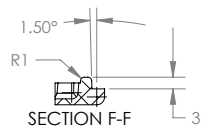
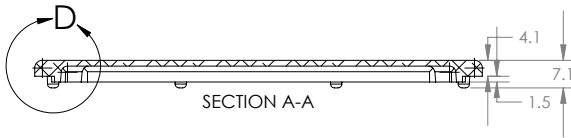
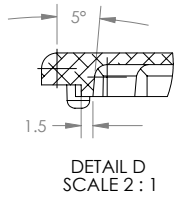

Tel No. +44(0)1724273200 Website www.dem-uk.com



**PROPRIETARY AND CONFIDENTIAL**  
THE INFORMATION CONTAINED IN THIS DRAWING IS THE SOLE PROPERTY OF ALPHA 3 MANUFACTURING. ANY REPRODUCTION IN PART OR AS A WHOLE WITHOUT THE WRITTEN PERMISSION OF ALPHA 3 MANUFACTURING IS PROHIBITED.

DEM Manufacturing, Deltron Emicon House  
Hargreaves Way, Sawcliffe Ind. Park,  
Scunthorpe, North Lincolnshire, DN15 8PF, UK

UNLESS OTHERWISE SPECIFIED:  
DIMENSIONS ARE IN MILLIMETRES  
LINEAR TOLERANCE:  
**NO DECIMAL PLACES ±0.5mm**  
**1 DECIMAL PLACE ±0.25mm**  
**2 DECIMAL PLACES ±0.125mm**  
ANGULAR TOLERANCE: ±1°

FINISH: -  
DEBURR AND BREAK SHARP EDGES  
DRAWN BY: B.SILLENCE  
APPROVED BY: B.SILLENCE  
IF IN DOUBT ASK DO NOT SCALE DRAWING  
MATERIAL: DieCast Aluminium Alloy

BASED ANGLE PROJECTION

B.SILLENCE  
SHEET 1 OF 1  
SCALE 1:1  
A3

TITLE: **PROCUREMENT SPECIFICATION FOR 'D' SIZE BOX LID**  
DRAWING NO.: D LID  
ISSUE: 08  
Release