

	GENERAL PURPOSE		
SIZE	PLAIN	POWDER COATED	NYLON COATED
D	459-0040	461-0040	462-0040
<b>SEALED</b>			
D	460-0040	453-0040	454-0040

Tel No. +44(0)1724273200 Website www.dem-uk.com



**PROPRIETARY AND CONFIDENTIAL**  
THE INFORMATION CONTAINED IN THIS DRAWING IS THE SOLE PROPERTY OF ALPHA 3 MANUFACTURING. ANY REPRODUCTION IN PART OR AS A WHOLE WITHOUT THE WRITTEN PERMISSION OF ALPHA 3 MANUFACTURING IS PROHIBITED.

DEM Manufacturing, Deltron Emicon House  
Haggreaves Way, Sawcliffe Ind. Park,  
Scunthorpe, North Lincolnshire, DN15 8PF, UK

UNLESS OTHERWISE SPECIFIED:  
DIMENSIONS ARE IN MILLIMETRES  
LINEAR TOLERANCE:  
**NO DECIMAL PLACES ±0.5mm**  
**1 DECIMAL PLACE ±0.25mm**  
**2 DECIMAL PLACES ±0.125mm**  
ANGULAR TOLERANCE: ±1°

FINISH -  
DEBURR AND BREAK SHARP EDGES

IF IN DOUBT ASK  
DO NOT SCALE DRAWING

MATERIAL DieCast Aluminium Alloy

DRAWN BY B.SILLENCE  
APPROVED BY ?



SHEET 1 OF 1  
SCALE 1:1.5

DRAWING NO. D BOX  
ISSUE 01  
Release

TITLE **PROCUREMENT SPECIFICATION FOR 'D' SIZE DIECAST BOX**

DRAWING NO. D BOX  
ISSUE 01  
Release

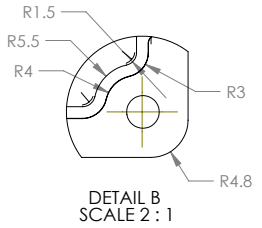
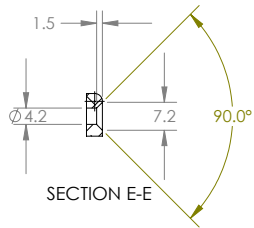
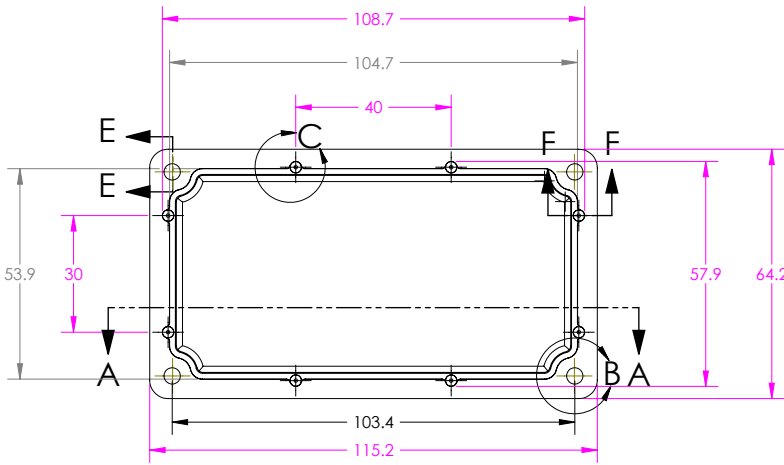
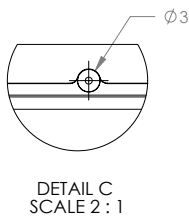
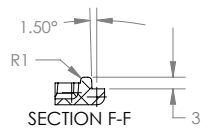
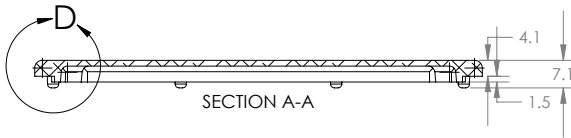
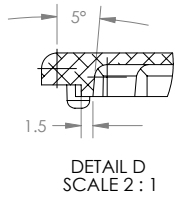

Tel No. +44(0)1724273200 Website www.dem-uk.com



**PROPRIETARY AND CONFIDENTIAL**  
THE INFORMATION CONTAINED IN THIS DRAWING IS THE SOLE PROPERTY OF ALPHA 3 MANUFACTURING. ANY REPRODUCTION IN PART OR AS A WHOLE WITHOUT THE WRITTEN PERMISSION OF ALPHA 3 MANUFACTURING IS PROHIBITED.

DEM Manufacturing, Deltron Emicon House  
Hargreaves Way, Sawcliffe Ind. Park,  
Scunthorpe, North Lincolnshire, DN15 8PF, UK

UNLESS OTHERWISE SPECIFIED:  
DIMENSIONS ARE IN MILLIMETRES  
LINEAR TOLERANCE:  
**NO DECIMAL PLACES ±0.5mm**  
**1 DECIMAL PLACE ±0.25mm**  
**2 DECIMAL PLACES ±0.125mm**  
ANGULAR TOLERANCE: ±1°

FINISH: -  
DEBURR AND BREAK SHARP EDGES  
DRAWN BY: B.SILLENCE  
APPROVED BY: B.SILLENCE  
IF IN DOUBT ASK DO NOT SCALE DRAWING  
MATERIAL: DieCast Aluminium Alloy

BASED ANGLE PROJECTION  
SHEET 1 OF 1  
SCALE 1:1  
A3

TITLE: **PROCUREMENT SPECIFICATION FOR 'D' SIZE BOX LID**  
DRAWING NO.: D LID  
ISSUE: 08  
Release