

SIZE	GENERAL PURPOSE		
	PLAIN	POWDER COATED	NYLON COATED
C	459-0030	461-0030	462-0030
<b>SEALED</b>			
C	460-0030	453-0030	454-0030

Tel No. +44(0)1724273200 Website www.dem-uk.com



**PROPRIETARY AND CONFIDENTIAL**  
THE INFORMATION CONTAINED IN THIS DRAWING IS THE SOLE PROPERTY OF ALPHA 3 MANUFACTURING. ANY REPRODUCTION IN PART OR AS A WHOLE WITHOUT THE WRITTEN PERMISSION OF ALPHA 3 MANUFACTURING IS PROHIBITED.

UNLESS OTHERWISE SPECIFIED:  
DIMENSIONS ARE IN MILLIMETRES  
LINEAR TOLERANCE:  
**NO DECIMAL PLACES ±0.5mm**  
**1 DECIMAL PLACE ±0.25mm**  
**2 DECIMAL PLACES ±0.125mm**  
ANGULAR TOLERANCE: ±1°

FINISH -  
DEBURR AND BREAK SHARP EDGES  
DRAWN BY B.SILLENCE  
APPROVED BY WC  
SHEET 1 OF 1  
SCALE 1:1.5  
MATERIAL DieCast Aluminium Alloy

IF IN DOUBT ASK  
DO NOT SCALE DRAWING  
FIRST ANGLE PROJECTION

TITLE  
**PROCUREMENT SPECIFICATION FOR 'C' SIZE DIECAST BOX**  
DRAWING NO. C BOX  
ISSUE 01  
Release

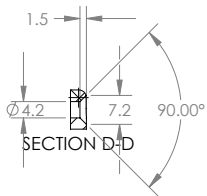
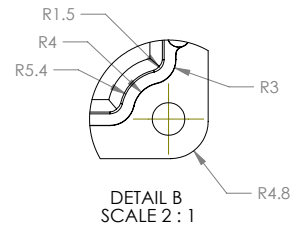
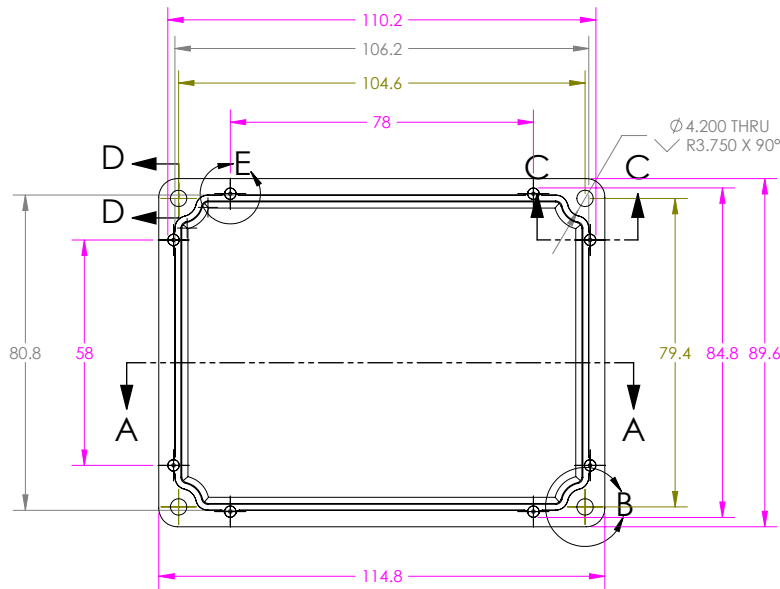
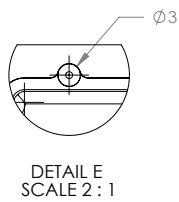
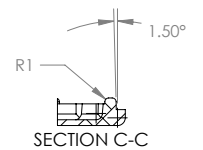
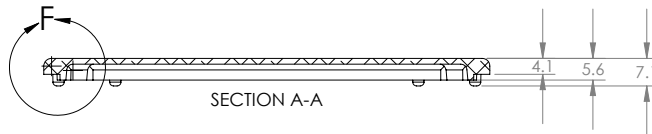
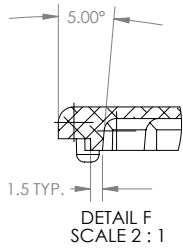

Tel No. +44(0)1724273200 Website www.dem-uk.com



**PROPRIETARY AND CONFIDENTIAL**  
THE INFORMATION CONTAINED IN THIS DRAWING IS THE SOLE PROPERTY OF ALPHA 3 MANUFACTURING. ANY REPRODUCTION IN PART OR AS A WHOLE WITHOUT THE WRITTEN PERMISSION OF ALPHA 3 MANUFACTURING IS PROHIBITED.

DEM Manufacturing, Deltron Emicon House  
Haggreaves Way, Sawcliffe Ind. Park,  
Scunthorpe, North Lincolnshire, DN15 8BF, UK

UNLESS OTHERWISE SPECIFIED:  
DIMENSIONS ARE IN MILLIMETRES  
LINEAR TOLERANCE:  
**NO DECIMAL PLACES ±0.5mm**  
**1 DECIMAL PLACE ±0.25mm**  
**2 DECIMAL PLACES ±0.125mm**  
ANGULAR TOLERANCE: ±1°

FINISH -  
DEBURR AND BREAK SHARP EDGES  
DRAWN BY B.SILLENCE  
APPROVED BY B.SILLENCE  
IF IN DOUBT ASK DO NOT SCALE DRAWING  
MATERIAL DieCast Aluminium Alloy

BASED ANGLE PROJECTION

B.SILLENCE  
SHEET 1 OF 1  
SCALE 1:1  
A3

TITLE **PROCUREMENT SPECIFICATION FOR 'C' SIZE BOX LID**  
DRAWING NO. C LID  
ISSUE 07  
Release