

SIZE	PLAIN	FLANGED	
		POWDER COATED	NYLON COATED
B	455-0020	457-0020	458-0020
	SEALED	FLANGED	
B	456-0020	463-0020	464-0020

Tel No. +44(0) 1724273200 Website www.dem-uk.com

Alpha 3 (Manufacturing) **ROXBURGH EMC** **DELTRON Components** **DELTRON Enclosures** **DEM**

PROPRIETARY AND CONFIDENTIAL
THE INFORMATION CONTAINED IN THIS DRAWING IS THE SOLE PROPERTY OF ALPHA 3 MANUFACTURING. ANY REPRODUCTION IN PART OR AS A WHOLE WITHOUT THE WRITTEN PERMISSION OF ALPHA 3 MANUFACTURING IS PROHIBITED.

UNLESS OTHERWISE SPECIFIED: DIMENSIONS ARE IN MILLIMETRES
LINEAR TOLERANCE:
NO DECIMAL PLACES ±0.5mm
1 DECIMAL PLACE ±0.25mm
2 DECIMAL PLACES ±0.125mm
ANGULAR TOLERANCE: ±1°

FINISH: -
DEBURR AND BREAK SHARP EDGES
DRAWN BY: B.SILLENCE
APPROVED BY: B.SILLENCE
SHEET 1 OF 1
SCALE 1:1
MATERIAL: DieCast Aluminium Alloy

IF IN DOUBT ASK
DO NOT SCALE DRAWING

BASED ANGLE PROJECTION

PROCUREMENT SPECIFICATION FOR 'B' SIZE FLANGED BOX
DRAWING NO. B BOX FLANGED
ISSUE 01
Release

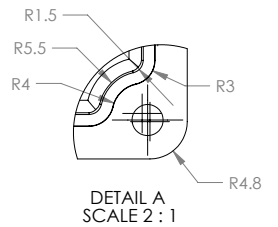
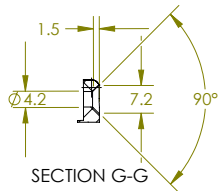
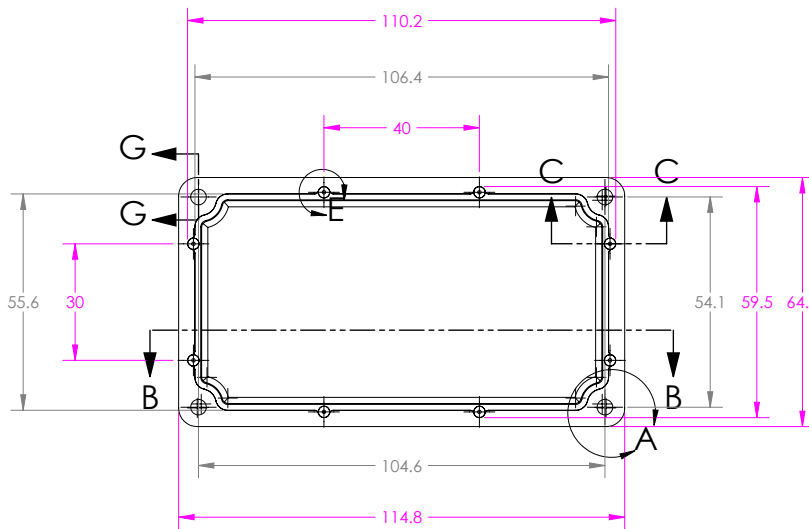
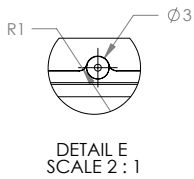
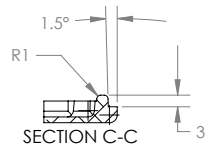
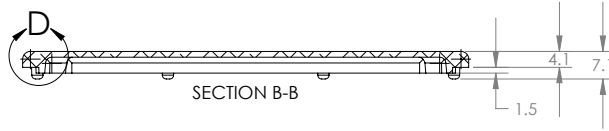
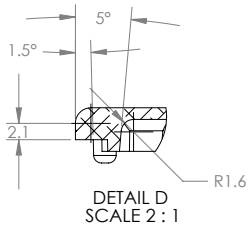

Tel No. +44(0)1724273200 Website www.dem-uk.com



PROPRIETARY AND CONFIDENTIAL
THE INFORMATION CONTAINED IN THIS DRAWING IS THE SOLE PROPERTY OF ALPHA 3 MANUFACTURING. ANY REPRODUCTION IN PART OR AS A WHOLE WITHOUT THE WRITTEN PERMISSION OF ALPHA 3 MANUFACTURING IS PROHIBITED.

DEM Manufacturing, Deltron Emcon House
Haggreaves Way, Sawcliffe Ind. Park,
Scunthorpe, North Lincolnshire, DN15 8BF, UK

UNLESS OTHERWISE SPECIFIED:
DIMENSIONS ARE IN MILLIMETRES
LINEAR TOLERANCE:
NO DECIMAL PLACES ±0.5mm
1 DECIMAL PLACE ±0.25mm
2 DECIMAL PLACES ±0.125mm
ANGULAR TOLERANCE: ±1°

FINISH	-	DEBURR AND BREAK SHARP EDGES
MATERIAL	DieCast Aluminium Alloy	
IF IN DOUBT ASK DO NOT SCALE DRAWING		

DRAWN BY	B.SILLENCE
APPROVED BY	B.SILLENCE
BASED ANGLE PROJECTION	

SHEET 1 OF 1
SCALE 1:1
A3

TITLE		PROCUREMENT SPECIFICATION FOR 'B' SIZE BOX LID	
DRAWING NO.	B LID	ISSUE	01
		Release	