

## MODEL 610

The Duncan 600 Series provides an extremely accurate method of position sensing in applications that require a rugged instrument operating in a tight area. Its long life, infinite resolution and very smooth output deliver high reliability in critical measurements.

Seven models provide a choice of electrical travel from 1" (25mm) to 12" (305mm), and include a floating shaft design to accommodate shaft/interface connecting misalignments. Accessories for the 600 Series include a rod end bearing and mounting bracket.

### ELECTRICAL SPECIFICATIONS

**Electrical Travel:**

1.00" (25mm) to 12.00" (305mm) (See table)

**Resistance Range:**

1.0K to 12.0K $\Omega$  standard (See table)

**Resistance Tolerance:**

$\pm 20\%$

**Independent Linearity:**

$\pm 0.70$  to  $0.08\%$  (See table)

**Power Rating at 70°C:**

0.25 watts

Per inch of electrical travel derated  
to 0 watts at 125°C

**Output Smoothness:**

0.1%

**Resolution:**

Infinite

**Insulation Resistance at 500 VDC:**

1000 megohms

**Dielectric Strength:**

500 VRMS

**Temperature Range:**

-55 to +125°C

### MECHANICAL SPECIFICATIONS

**Mechanical Travel:**

Electrical travel +0.1 inch min.

**Actuation Force:**

2 oz. max.

**Repeatability:**

Within .0005 in.

**Life:**

$10 \times 10^6$  Cycles

**Shaft Alignment:**

Floating shaft design allows for shaft/interface  
misalignment up to 0.010" (.25).

Shaft rotates freely

**NOTES:**

- 1 Available in dual configuration.
- 2 Most specifications may be altered to meet specific requirements.
- 3 Other travels available.

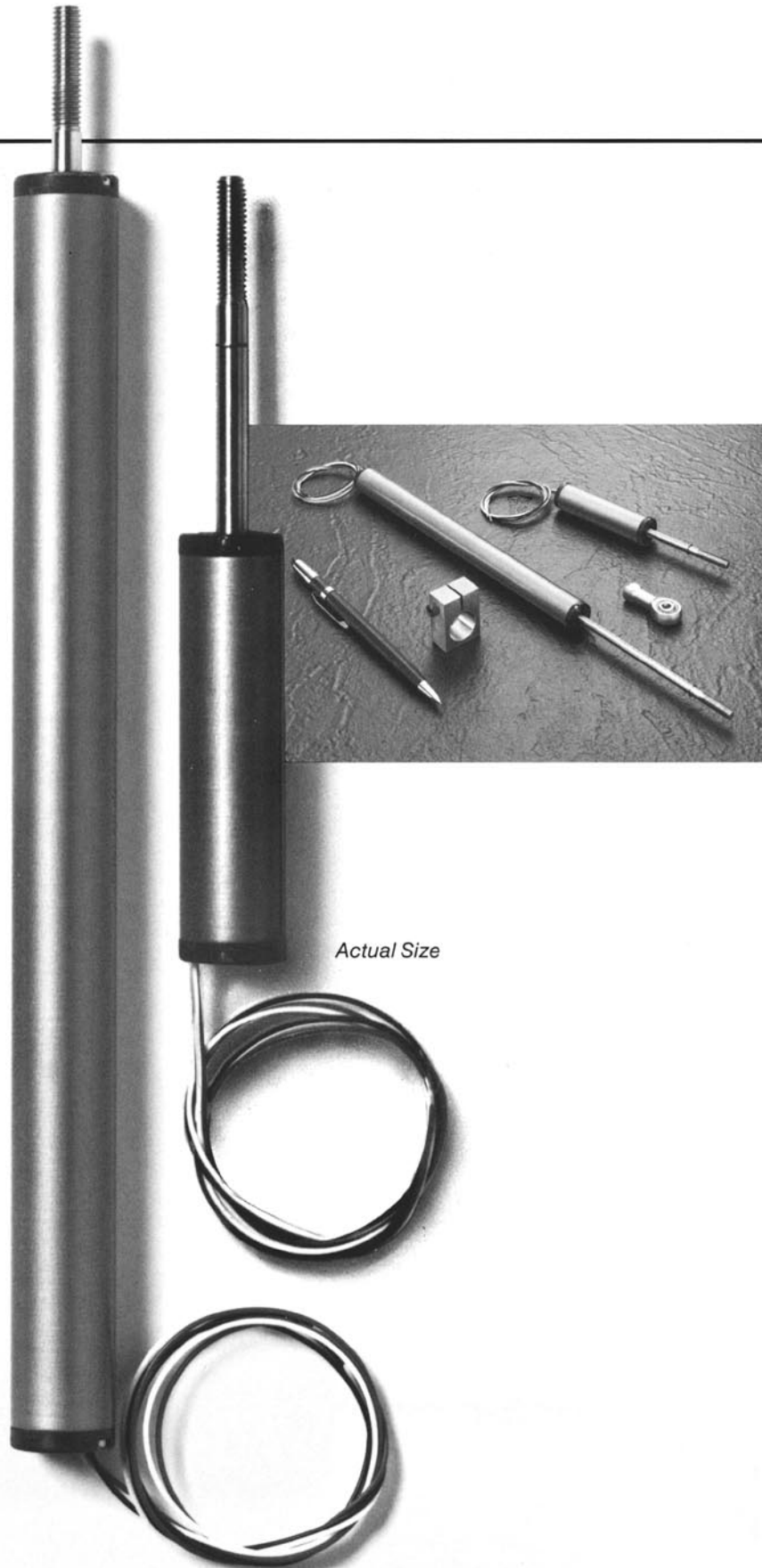

# LINEAR MOTION POSITION SENSOR INFINITE RESOLUTION

## OUTLINE SPECIFICATIONS

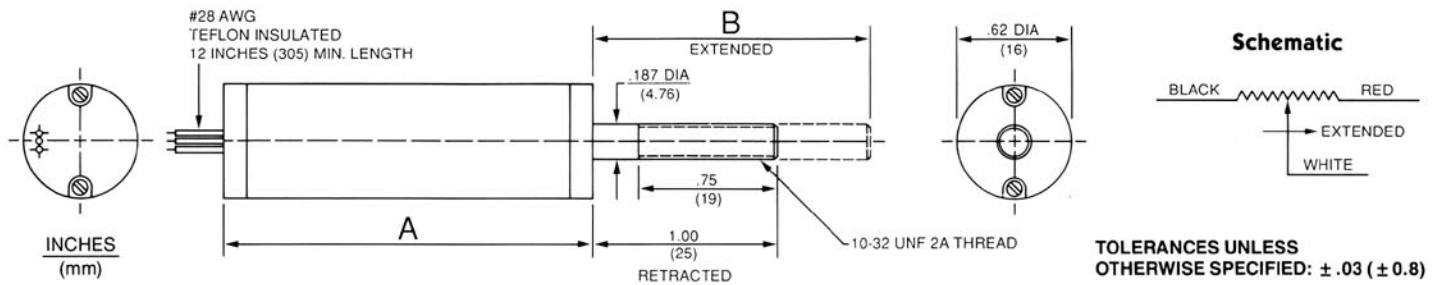

<b>MODEL</b>	<b>610</b>
Resistance K $\Omega$	10.0
Linearity $\pm$ %	0.09
Electrical Travel inches (mm)	10.00 (254)
<b>Case Dimensions</b>	
A inches (mm)	11.50 (292)
B inches (mm)	11.10 (282)

## ACCESSORIES

ROD END BEARING  
600-52

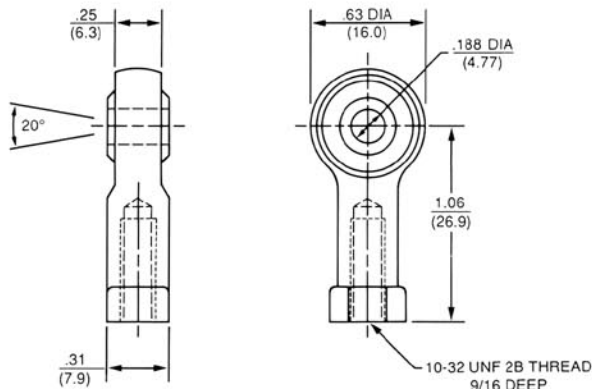

MOUNTING BRACKET  
600-51

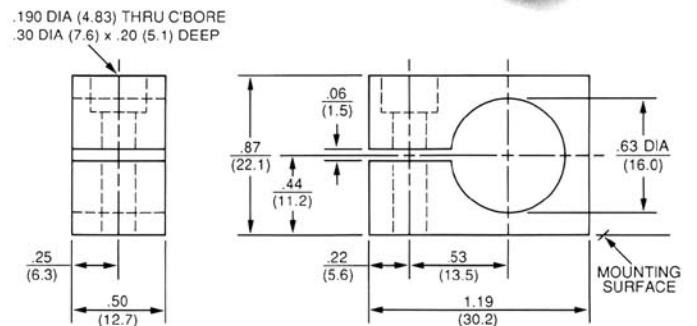
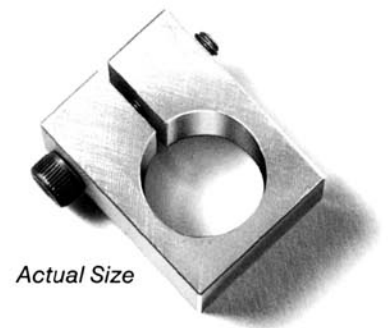

INCHES  
(mm)

**TOLERANCES UNLESS OTHERWISE SPECIFIED:  $\pm .03$  ( $\pm 0.8$ )**