

Features

- Linear Position Sensor
- IP65 Dust Proof, Water Proof (Intense Spray)
- Polyester Substrate
- 3M Pressure Sensitive Adhesive (PSA)
- Upon Request
 - Male or Female Nicomatic or Berg Connectors
 - Wiper of 1-3 Newton Force to Actuate Part
 - Higher Temperature and/or Contactless Options Available



Mechanical Specifications

- Life Cycle: >1 million
- Height: $\leq 0.51\text{mm}$ (0.020")
- Actuation Force (with a 10mm wide active cavity):
 - 40°C 0.8 to 1.8 N
 - 25°C 0.8 to 1.8 N
 - +23°C 0.6 to 1.5 N
 - +50°C 0.6 to 1.5 N

Environmental Specifications

- Operating Temperature: -40°C to +50°C
- Humidity: No affect @ 95% RH, 4hrs 50°C
- IP Rating of Active Area: IP65

Electrical Specifications

- Resistance - Standard: 10k Ohms (lengths >300mm = 20k Ohms)
- Resistance - Custom: 1k to 100k Ohms
- Resistance Tolerance: $\pm 20\%$
- Effective Electrical Travel: 8 to 2000mm
- Linearity (Independent): Linear $\pm 1\%$ & 3% Rotary $\pm 3\%$ & 5%
- Repeatability: No hysteresis, but with any wiper looseness some hysteresis will occur
- Power Rating (depending on size, varies with length and temperature): 1 Watt max. @ 25°C, ≤ 0.5 Watt recommended
- Resolution: Analog output theoretically infinite; affected by variation of contact wiper surface area.
- Dielectric Value: No affect @ 500VAC for 1 minute

Dimensional Diagram - Stock Linear SoftPot

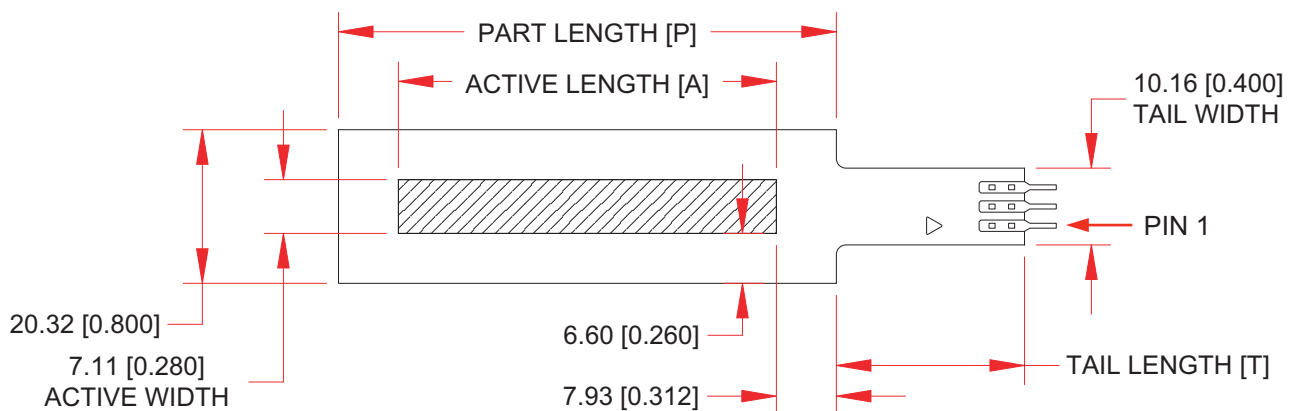

A	12.50mm 0.492"	25.00mm 0.984"	50.00mm 1.969"	100.00mm 3.937"	150.00mm 5.906"	170.00mm 6.693"	200.00mm 7.874"	300.00mm 11.811"	400.00mm 15.748"	500.00mm 19.685"	750.00mm 29.528"	1000.00mm 39.370"
P	28.36mm 1.117"	40.86mm 1.609"	65.86mm 2.593"	115.86mm 4.562"	165.86mm 6.531"	185.86mm 7.318"	215.86mm 8.499"	315.86mm 12.436"	415.86mm 16.373"	515.86mm 20.310"	765.86mm 30.153"	1015.86mm 39.995"
T	12.70mm 0.500"		24.89mm 0.980"									

Electrical Schematic

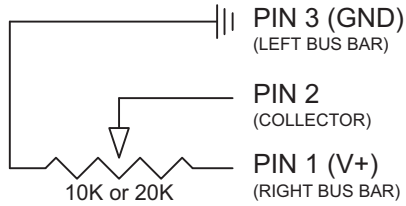

Material Cross-Section

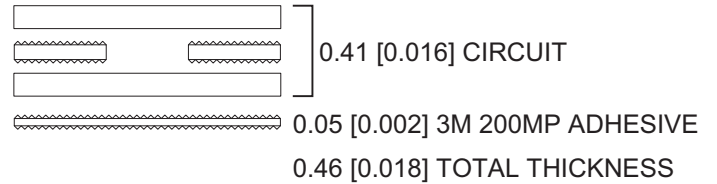

How to Order - Linear SoftPots

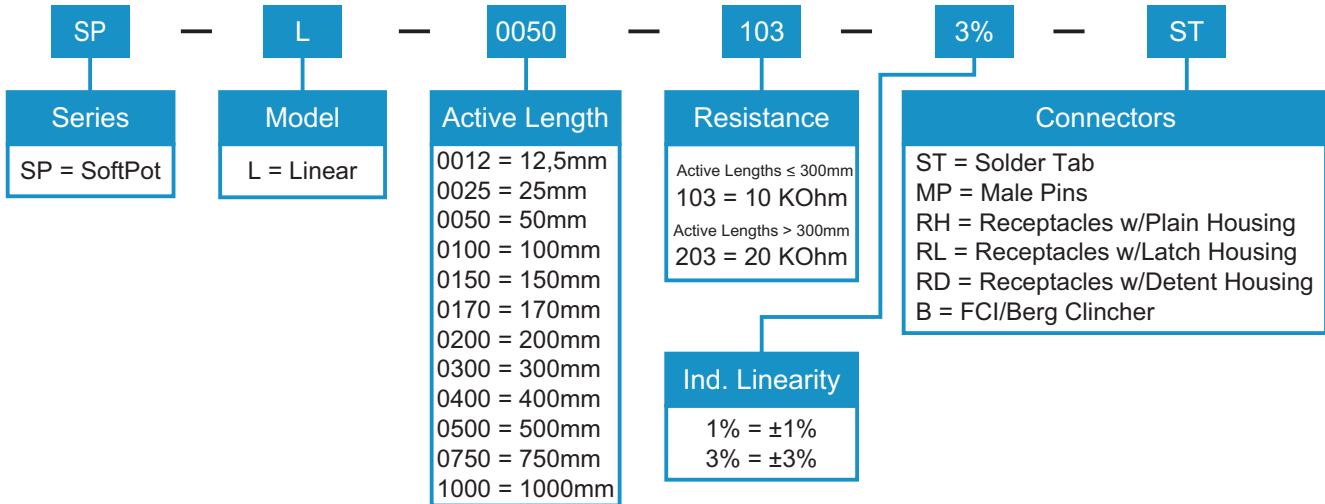

Standard Connector Options

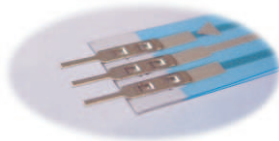

Crimpflex Solder Tab (ST)

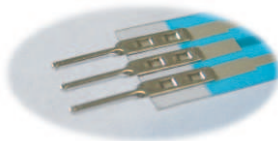

Crimpflex Short Male Pins (MP)

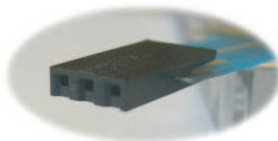

Crimpflex Female Receptacles with a Plain Housing (RH)



Crimpflex Female Receptacles with a Latch Housing (RL)

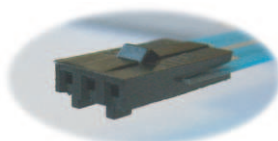

Crimpflex Female Receptacles with a Detent Housing (RD)



FCI/Berg Clincher (B)

Customization

Customize the size, shape, and even the number of tracks. Such custom requests, for example, can be: multiple ganged sensors (up to 40 tracks); serpentine active area track; custom lengths 10mm-2000mm; custom rotary diameters, etc. Feel free to contact Spectra Symbol with your custom request at sales@spectrasymbol.com or (888)795-2283..

How It Works

In simple terms, the SoftPot membrane potentiometer is a resistive element, which comprises a conductive resistor, a sealed encasement and a simple wiper assembly. A membrane potentiometer can also function as a voltage divider.

The SoftPot is a three-wire system with two resistive output channels and an electrical collector channel.



By pressing a wiper down onto the top circuit the SoftPot produces the desired electrical output. The "wiper" is a non-conductive mechanism that depresses the top circuit actuating the potentiometer from the outside of the element. The top and bottom circuits are separated by 0.15mm (0.006") of spacer adhesive build-up and contact between the circuit occurs by pressure (usually 1-3 Newtons) from the wiper on the top circuit, pushing down until the top circuit connects with the bottom circuit to create a potentiometric output.

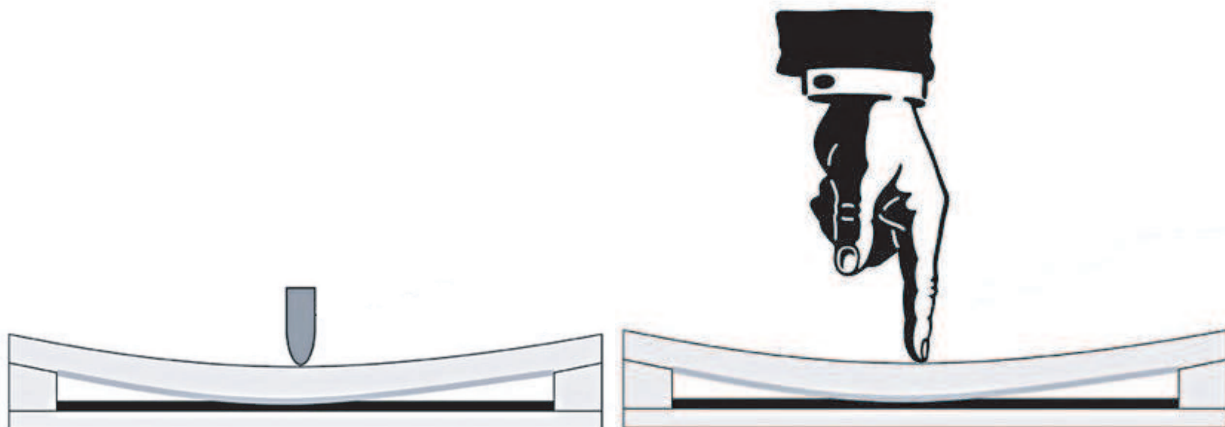

The construction of the wiper design can adapt to any application because most materials can serve as the wiper: plastics, metals, sliders, rollers, wheels, etc. Also, the SoftPot can also be manually (hand) actuated.

Wiper

Typical wiper materials are delrin, plastic injection molded products, metal rollers with back-loaded springs, sliders attached to lead-screws, etc. With small quantities, an off-the-shelf solution might be easier, while with higher quantities or space limitations a custom wiper may be required.

The stock 1-3 Newton wiper is an excellent product for most applications. In case of unique applications, extreme environment or cycle needs, it is recommended to seek the advice of the Spectra Symbol Design Department. The selection of the correct wiper (material, form) can affect the life cycle and electrical output of the SoftPot.

Stock Wiper

Mechanical Specifications

- Minimum Force: 1 Newton
- Maximum Force: 3 Newtons
- Tip Material: Delrin
- Thread Pitch: M1.0 (1mm)

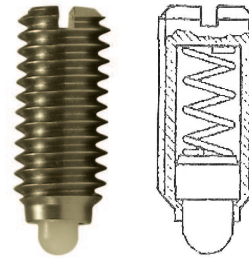

Dimensional Diagram

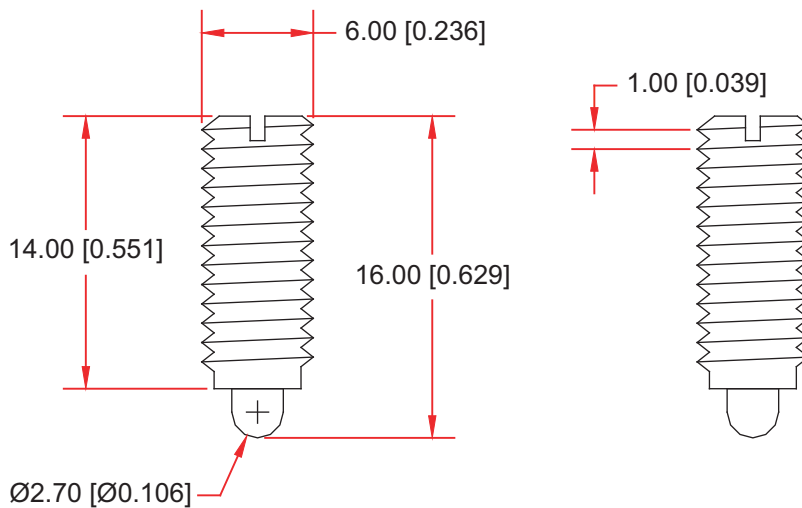

How to Order - Stock Wiper

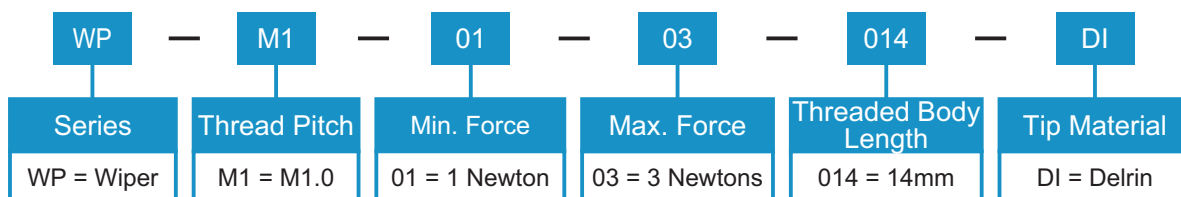
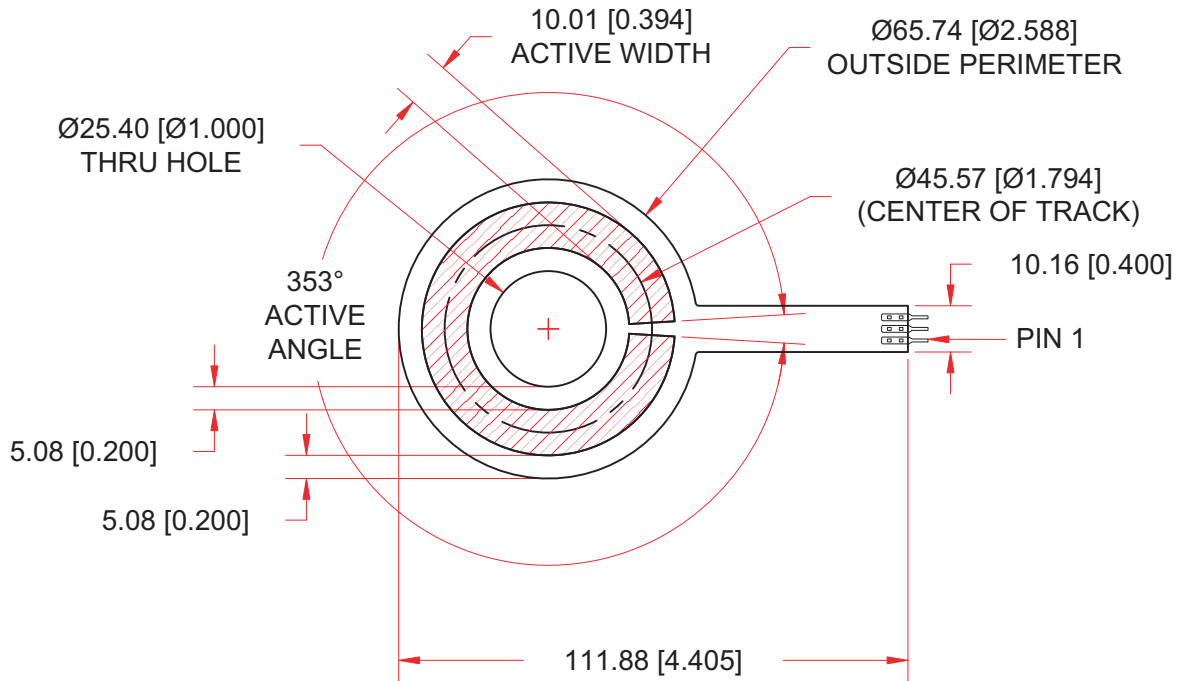
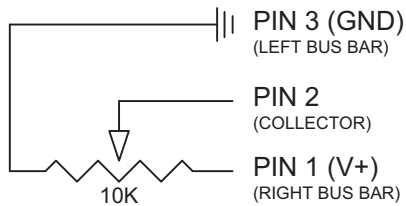

Diagram - Stock Rotary SoftPot



Electrical Schematic



Material Cross-Section

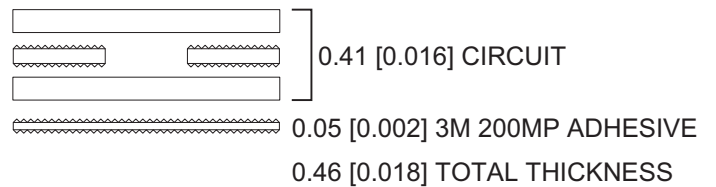

How to Order - Rotary SoftPot

