

Hall Effect Current Sensors L07P***D15 Series

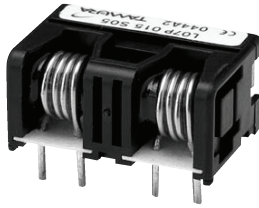

Features:

- Open Loop type
- Dual integrated primary
- Bipolar power supply
- Printed circuit board mounting
- Insulated plastic case according to UL94V0

Advantage:

- Excellent accuracy and linearity
- Wide nominal current range
- Low temperature drift
- Wide frequency bandwidth
- No insertion loss
- High Immunity To External Interference
- Optimised response time
- Current overload capability

Specifications

$T_A=25^{\circ}\text{C}$, $V_{CC}=\pm 15\text{V}$, $R_L=10\text{k}\Omega$

Parameters	Symbol	L07P003D15	L07P005D15	L07P010D15	L07P015D15	L07P020D15	L07P025D15	L07P030D15
Rated current	I_f	$\pm 3\text{A}$	$\pm 5\text{A}$	$\pm 10\text{A}$	$\pm 15\text{A}$	$\pm 20\text{A}$	$\pm 25\text{A}$	$\pm 30\text{A}$
Maximum Current	I_{fmax}	$\pm 9\text{A}$	$\pm 15\text{A}$	$\pm 30\text{A}$	$\pm 45\text{A}$	$\pm 60\text{A}$	$\pm 75\text{A}$	$\pm 90\text{A}$
Output Voltage	V_{OUT}	$4\text{V} \pm 60\text{mV} @ \pm I_f$						
Offset Voltage	V_{OE}	$0 \pm 60\text{mV} @ I_f = 0\text{A}$						
Accuracy ¹	X	$\pm 1\% @ I_f$						
Output Linearity ¹	ϵ_L	$\leq \pm 1\% @ I_f$						
Power Supply	V_{CC}	$\pm 15\text{V} \pm 5\%$						
Current Consumption	I_c	$\leq 15\text{mA}$ per channel						
Response Time	t_r	$\leq 5\mu\text{s} @ di/dt=I_f/\mu\text{s}$						
Output Temperature Characteristic ¹	TCV_{OUT}	$\leq \pm 2 \text{ mV}/^{\circ}\text{C}$						
Offset Temperature Characteristic	TCV_{OE}	$\leq \pm 2 \text{ mV}/^{\circ}\text{C} @ I_f=0\text{A}$						
Hysteresis error	V_{OH}	$\leq 30\text{mV} (0\text{A} \leftrightarrow I_f)$						
Withstand Voltage	V_d	AC2000V for 1minute (sensing current 0.5mA), inside of through hole \leftrightarrow terminal						
Insulation Resistance	R_{IS}	$> 500\text{M}\Omega$ (500V DC), inside of through hole \leftrightarrow terminal						
Frequency Bandwidth ²	f	DC .. 50kHz						
Operating Temperature	T_A	$-10^{\circ}\text{C} \sim +80^{\circ}\text{C}$						
Storage Temperature	T_s	$-15^{\circ}\text{C} \sim +85^{\circ}\text{C}$						

¹ Without offset — ² Small signal only to avoid excessive heating of magnetic core

Electrical Performances

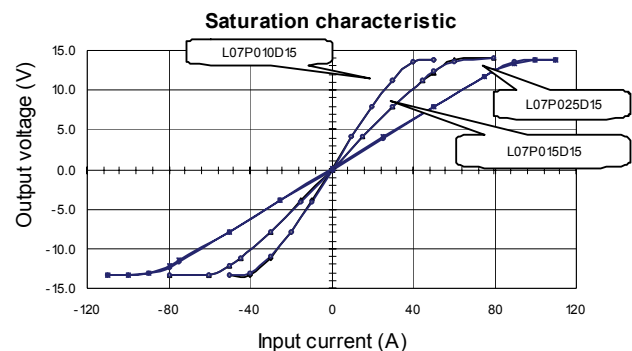
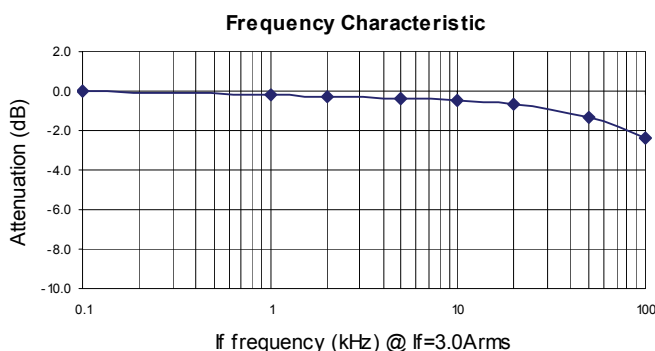

Hall Effect Current Sensors L07P***D15 Series

Mechanical dimensions in mm

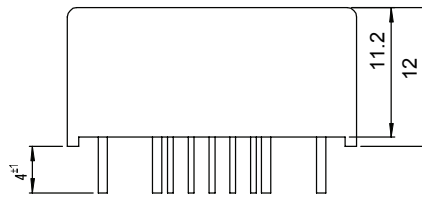
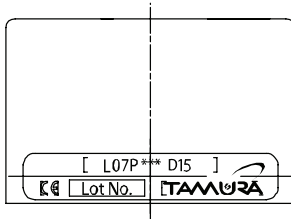

Terminal	Function
1	+15V
2	-15V
3	V _{OUT1}
4	V _{OUT2}
5	GND
6	+I _{f1}
7	-I _{f1}
8	+I _{f2}
9	-I _{f2}

A	φD
3A	φ0.6
5A	φ0.8
10~15A	φ1.4
20~30A	φ1.6

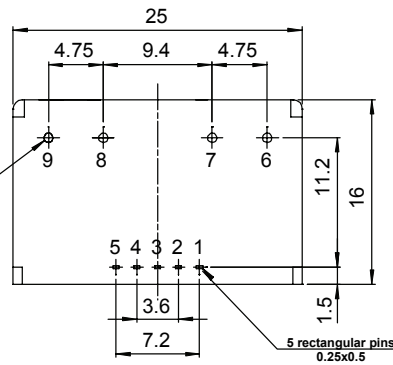

Electrical connection diagram

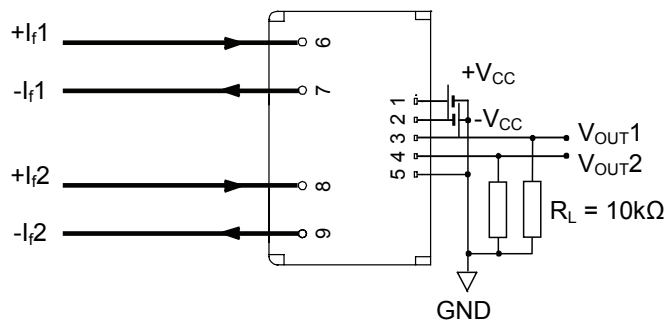

Package & Weight Information

Weight	Pcs/box	Pcs/carton	Pcs/pallet
12g	100	400	9600