

Hall Effect Current Sensors L18P***D15 Series

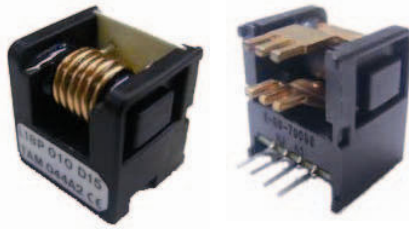

Features:

- Open Loop type
- Printed circuit board mounting
- Integrated primary
- Voltage output
- Busbar version from 40A to 60A
- Insulated plastic case according to UL94V0

Advantage:

- Excellent accuracy and linearity
- Wide nominal current range
- Low temperature drift
- Wide frequency bandwidth
- No insertion loss
- High Immunity To External Interference
- Optimised response time
- Current overload capability

Specifications

$T_A=25^{\circ}\text{C}$, $V_{CC}=\pm 15\text{V}$, $R_L=10\text{k}\Omega$

Parameters	Symbol	L18P003 D15	L18P005 D15	L18P010 D15	L18P015 D15	L18P020 D15	L18P025 D15	L18P030 D15	L18P040 D15	L18P050 D15	L18P060 D15
Rated current	I_f	$\pm 3\text{A}$	$\pm 5\text{A}$	$\pm 10\text{A}$	$\pm 15\text{A}$	$\pm 20\text{A}$	$\pm 25\text{A}$	$\pm 30\text{A}$	$\pm 40\text{A}$	$\pm 50\text{A}$	$\pm 60\text{A}$
Maximum Current	I_{fmax}	$\pm 9\text{A}$	$\pm 15\text{A}$	$\pm 30\text{A}$	$\pm 45\text{A}$	$\pm 60\text{A}$	$\pm 75\text{A}$	$\pm 90\text{A}$	$\pm 120\text{A}$	$\pm 150\text{A}$	$\pm 180\text{A}$
Output Voltage	V_{OUT}	$\pm 4\text{V} \pm 0.040\text{V} @ \pm I_f$							$\pm 4\text{V} \pm 0.050\text{V} @ \pm I_f$		
Offset Voltage	V_{OE}	$0\text{V} \pm 0.040\text{V} @ I_f = 0\text{A}$							$0\text{V} \pm 0.050\text{V} @ I_f = 0\text{A}$		
Accuracy ¹	X	$\pm 1\% @ I_f$									
Output Linearity ¹	ϵ_L	$\leq \pm 1\% @ I_f$									
Power Supply	V_{CC}	$\pm 15\text{V} \pm 5\%$									
Consumption Current	I_c	$\leq 15\text{mA}$									
Response Time	t_r	$\leq 5\mu\text{s} (@ di/dt = 10\text{A} / 5\mu\text{s})$									
Output Temperature Characteristic ¹	TCV_{OUT}	$\leq \pm 2.0\text{mV} / ^{\circ}\text{C}$									
Offset Temperature Characteristic	TCV_{OE}	$\leq \pm 1.5\text{mV} / ^{\circ}\text{C}$									
Hysteresis error	V_{OH}	$\leq 25\text{mV} (0\text{A} \leftrightarrow I_f)$							$\leq 40\text{mV} (0\text{A} \leftrightarrow I_f)$		
Withstand Voltage	V_d	AC3000V for 1minute (sensing current 0.5mA), inside of aperture \leftrightarrow terminal									
Insulation Resistance	R_{IS}	$> 500\text{M}\Omega (500\text{V DC})$, inside of aperture \leftrightarrow terminal									
Frequency Bandwidth ²	f	DC .. 50kHz									
Operating Temperature	T_A	$-20^{\circ}\text{C} \sim +85^{\circ}\text{C}$									
Storage Temperature	T_s	$-20^{\circ}\text{C} \sim +85^{\circ}\text{C}$									

¹ Without offset — ² Small signal only to avoid excessive heating of magnetic core

Electrical Performances

Frequency Characteristic (L18P050D15)

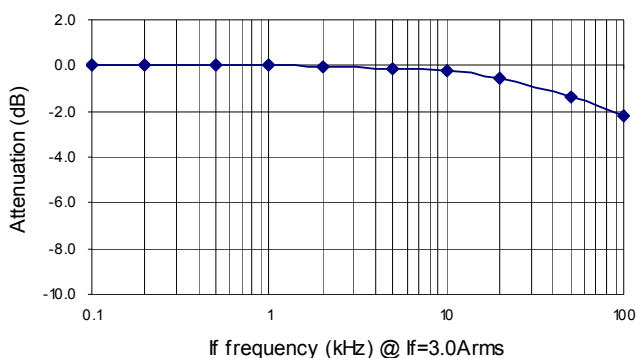

Saturation Characteristic (L18P050D15)

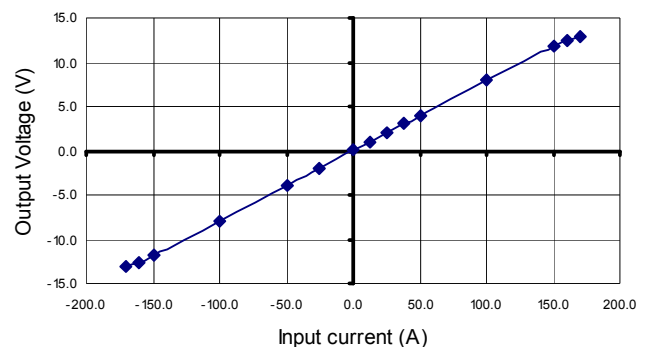

Hall Effect Current Sensors L18P***D15 Series

Mechanical dimensions in mm

Terminal Pin Identification

- 1: -V_{CC}
- 2: GND
- 3: +V_{CC}
- 4: Output
- 5: Primary input current (+)
- 6: Primary input current (-)

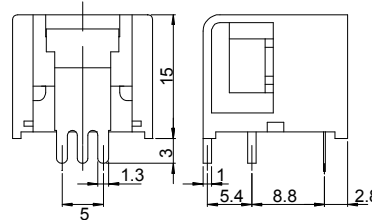
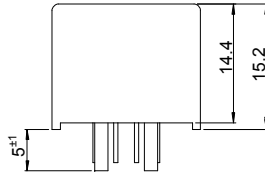
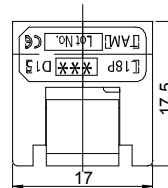
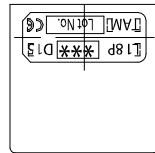

A	φD
3A	φ0.6
5A	φ0.8
10A	φ1.1
15A	φ1.4
20~30A	φ1.6

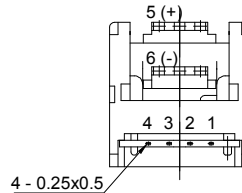
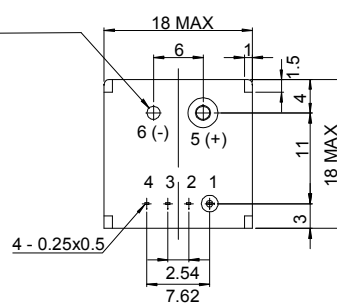

NOTES

- 1. Unit is mm
- 2. Tolerance is 0.5mm
- 3. Cover is optional

Electrical connection diagram

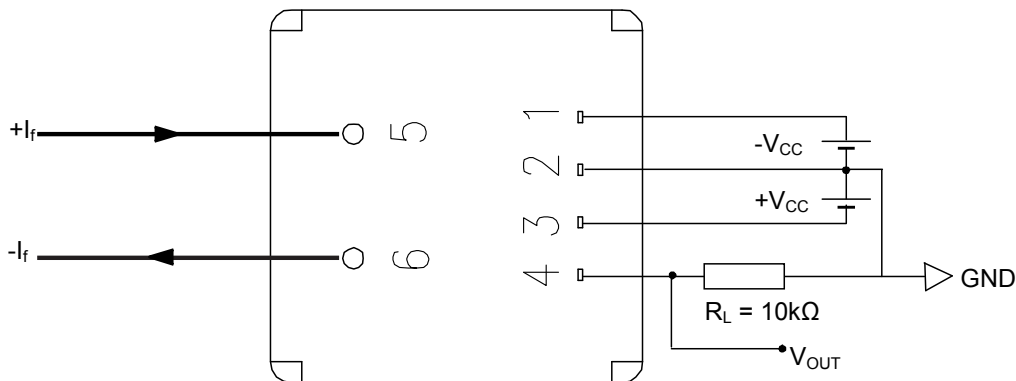

Package & Weight Information

Weight	Pcs/box	Pcs/carton	Pcs/pallet
8g	100	600	9600