

Honeywell Zephyr™ Analog Airflow Sensors: HAF Series—High Accuracy



DESCRIPTION

Honeywell Zephyr™ Analog Airflow Sensors: HAF Series-High Accuracy, provide an analog interface for reading airflow over the specified full scale flow span and temperature range. Their thermally isolated heater and temperature sensing elements help these sensors provide a fast response to air or gas flow.

Zephyr sensors are designed to measure mass flow of air and other non-corrosive gases. They are available in standard flow ranges and are fully calibrated and temperature compensated with an on-board Application Specific Integrated Circuit (ASIC).

The HAF Series is compensated over the temperature range of 0 °C to 50 °C [32 °F to 122 °F] and operates across a temperature range of -20 °C to 70 °C [-4 °F to 158 °F]. The state-of-the-art ASIC-based compensation provides analog outputs with a response time of 1 ms.

These sensors operate on the heat transfer principle to measure mass airflow. They consist of a microbridge Microelectronic and Microelectromechanical System (MEMS) with temperature-sensitive resistors deposited with thin films of platinum and silicon nitride. The MEMS sensing die is located in a precise and calculated airflow channel to provide repeatable flow response.

Zephyr sensors provide customers with enhanced reliability, analog accuracy, repeatable measurements and the ability to customize sensor options to meet many specific application needs. The combination of rugged housings with a stable substrate makes these products extremely robust. They are designed and manufactured according to ISO 9001 standards.

FEATURES AND BENEFITS (★= competitive differentiator)

- ★ High $\pm 2.5\%$ accuracy allows for very precise airflow measurement, often ideal for demanding applications with high accuracy requirements
- Full calibration and temperature compensation typically allow customer to remove additional components associated with signal conditioning from the PCB, reducing PCB size as well as costs often associated with those components (e.g., acquisition, inventory, assembly)
- ★ Customizable for specific end-user needs
- ★ High sensitivity at very low flows allows a customer's application to detect presence or absence of airflow
- ★ High stability reduces errors due to thermal effects and null shift to provide accurate readings over time, often eliminating need for system calibration after PCB mount and periodically over time
- ★ Low pressure drop typically improves patient comfort in medical applications, and reduces noise and system wear on other components such as motors and pumps
- ★ Linear output provides more intuitive sensor signal than the raw output of basic airflow sensors, which can help reduce production costs, design, and implementation time
- Fast response time allows a customer's application to respond quickly to airflow change, important in critical medical (i.e., anesthesia) and industrial (i.e., fume hood) applications
- 11-bit resolution increases ability to sense small airflow changes, allowing customers to more precisely control their application
- Low 3.3 Vdc operating voltage option and low power consumption allow for use in battery-driven and other portable applications
- Bidirectional flow sensing capability eliminates the need for two airflow sensors, helping to reduce production costs and implementation time
- Insensitivity to mounting orientation allows customer to position sensor in most optimal point in the system, eliminating concern for positional effects
- Insensitivity to altitude eliminates customer-implemented altitude adjustments in the system, easing integration and reducing production costs by not having to purchase additional sensors for altitude adjustments
- Small size occupies less space on PCB, allowing easier fit and potentially reducing production costs; PCB size may also be reduced for easier fit into space-constrained applications
- RoHS-compliant materials meet Directive 2002/95/EC

Honeywell Zephyr™ Analog Airflow Sensors

POTENTIAL APPLICATIONS

Medical

- Anesthesia delivery machines
- Ventricular assist devices (heart pumps)
- Hospital diagnostics (spectrometry, gas chromatography)
- Nebulizers
- Oxygen concentrators
- Patient monitoring systems (respiratory monitoring)
- Sleep apnea machines
- Spirometers
- Ventilators

Industrial

- Air-to-fuel ratio
- Analytical instrumentation (spectrometry, chromatography)
- Fuel cells
- Gas leak detection
- Gas meters
- HVAC filters
- VAV system on HVAC systems
- Meteorology

Table 1: Absolute Maximum Ratings¹

Characteristic	Parameter
Supply voltage	-0.3 Vdc to 6.0 Vdc
Voltage on output pin	-0.3 V to Vsupply
Storage temperature range	-40 °C to 125 °C [-40 °F to 257 °F]
Maximum flow change	5.0 SLPM/s
Maximum common mode pressure	25 psi at 25 °C [77 °F]
Maximum flow	10 SLPM

CAUTION

IMPROPER USE

Do not use these products to sense liquid or fluid flow.

Failure to comply with these instructions may result in product damage.

Note 1: Using the sensor at or beyond the Absolute Maximum Ratings may affect the reliability of the device or cause permanent damage. This is a stress rating only. Using the sensor beyond the operational characteristic ranges may still affect the functional operation of the device.

Table 2: Operating Characteristics

Characteristic	Parameter	Note
Supply voltage	3.3 Vdc \pm 10%; 5.0 Vdc \pm 10%	–
Current draw	16 mA max. (no load)	–
Power:		–
3.3 Vdc	40 mW typ. (no load)	
5.0 Vdc	55 mW typ. (no load)	
Operating temperature range	-20 °C to 70 °C [-4 °F to 158 °F]	–
Compensated temperature range	0 °C to 50 °C [32 °F to 122 °F]	1
Accuracy:		2, 4
forward flow	\pm 0.25% FSS or \pm 2.5% Reading, whichever is greater	
reverse flow	\pm 0.25% FSS or \pm 15% Reading, whichever is greater	
Total error band:		3, 4
forward flow:	\pm 0.25% FSS or \pm 4.5% Reading, whichever is greater	
reverse flow:	\pm 0.25% FSS or \pm 15% Reading, whichever is greater	
Null accuracy	\pm 0.08 %FSS	4, 8
Response time	1 ms typ.	5
Resolution	11 bit	–
Warm up time	15 ms	6
Calibration media	gaseous nitrogen	7
Null stability	\pm 0.06 FSS max. deviation from null output after 1000 hrs at 25 °C	–
Reverse polarity protection	no	–

Notes:

1. Custom and extended compensated temperature ranges are possible. Contact Honeywell for details.
2. Accuracy is the maximum deviation from the nominal digital output over the compensated flow range at a reference temperature of 25 °C. Errors include offset, span, non-linearity, hysteresis and non-repeatability (see Figure 3 for the Accuracy Error Band vs Flow).
3. Total error band includes all errors over the compensated flow range including all effects due to temperature over the compensated temperature range (see Figure 4 for the Total Error Band).
4. Full Scale Span (FSS) is the algebraic difference between the digital output at the forward Full Scale (FS) flow and the digital output at the reverse FS flow. Forward flow is defined as flow from P1 to P2 as shown in Figure 4. The references to mass flow (SCCM) refer to gas flows at the standard conditions of 0 °C and atmospheric pressure 760 (101.3 kPa).
5. Response time: time to electrically respond to any mass flow change at the microbridge airflow transducer (response time of the transducer may be affected by the pneumatic interface).
6. Warm-up time: time to the first valid flow measurement after power is applied.
7. Default calibration media is dry nitrogen gas. Please contact Honeywell for other calibration options.
8. Null accuracy is the maximum deviation in output at 0 SCCM from the ideal transfer function over the compensated temperature range. This includes offset errors, thermal airflow hysteresis and repeatability errors.

HAF Series-High Accuracy

Table 3. Suggested Load

Characteristic	Parameter
Minimum suggested resistance: 3.3 Vdc 5.0 Vdc	3.3 kOhm 5.0 kOhm
Maximum suggested capacitance: 3.3 Vdc 5.0 Vdc	10 nF 10 nF

CAUTION

LARGE PARTICULATE DAMAGE

Use a 5-micron filter upstream of the sensor to keep media flow through the sensor free of condensing moisture and particulates. Large, high-velocity particles or conductive particles may damage the sensing element.

Failure to comply with these instructions may result in product damage.

Table 4. Environmental Characteristics

Characteristic	Parameter
Humidity	0% to 95% RH, non-condensing
Shock	100 g, 11 ms
Vibration	15 g at 20 Hz to 2000 Hz
ESD	Class 3B per MIL-STD 883G
Radiated Immunity	Level 3 from (80 MHz to 1000 MHz) per spec IEC61000-4-3

Table 5. Wetted Materials

Characteristic	Parameter
Covers	high temperature polymer
Substrate	PCB
Adhesives	epoxy
Electronic components	silicon, gold
Compliance	RoHS, WEEE

Table 6. Recommended Mounting and Implementation

Characteristic	Parameter
Mounting screw size	5-40
Mounting screw torque	0.68 N m [6 in-lb]
Tubing for long port style	70 durometer, size 0.125 inch inside diameter, 0.250 inch outside diameter silicone tubing
O-ring for short port style	AS568A, Size 7, Silicone, Shore A 70
O-ring for long port style	AS568A, Size 10, Silicone, Shore A 70
Filter recommendation	5-micron filter upstream of the sensor

Figure 1. Nomenclature and Order Guide

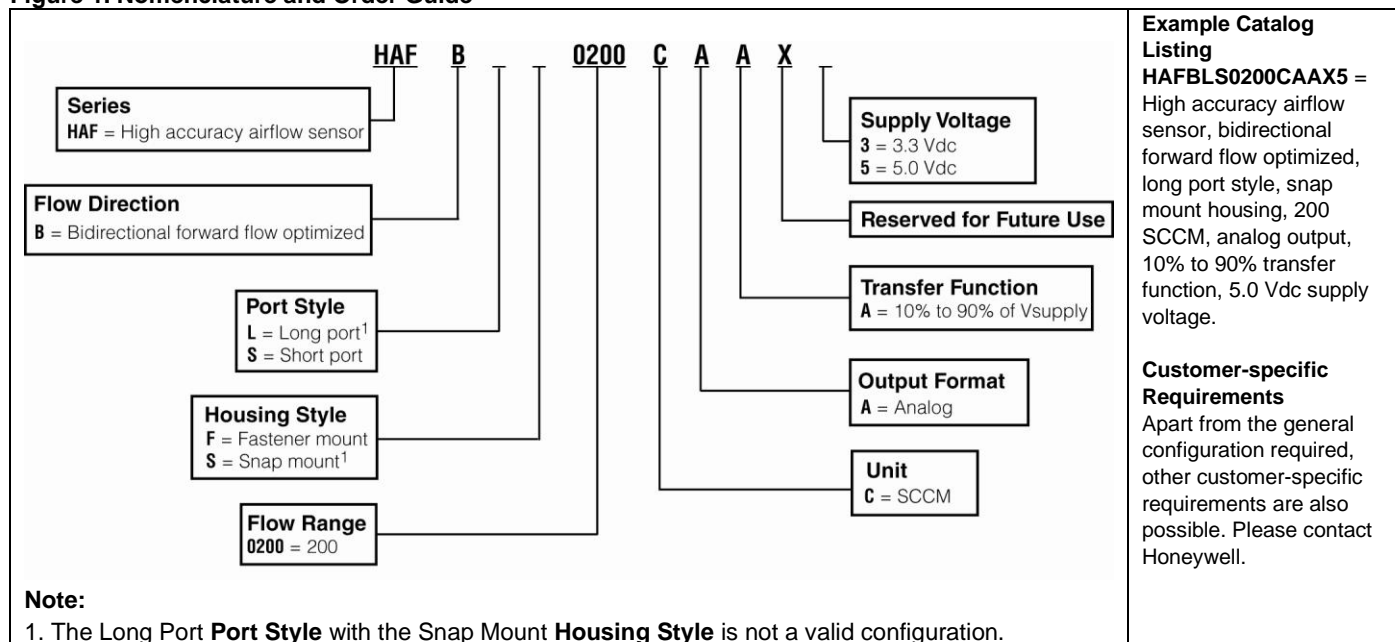

Honeywell Zephyr™ Analog Airflow Sensors

Figure 2. Nominal Analog Output

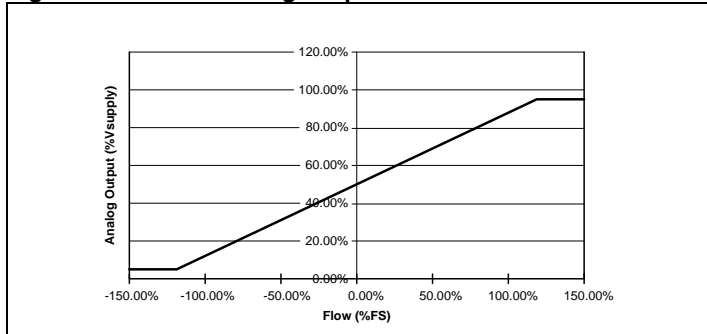

Figure 3. Ideal Transfer Function

$$V_o = V_s \left[0.5 + 0.4 \frac{F_A}{F_{FS}} \right]$$

$$F_A = \frac{F_{FS}(V_o/V_s - 0.5)}{0.4}$$

Where:
 V_o = Output voltage of the device
 V_s = Supply voltage measured at the device
 F_A = Flow applied across the device
 F_{FS} = Full scale flow specified for the device

Figure 4. Accuracy Error Band

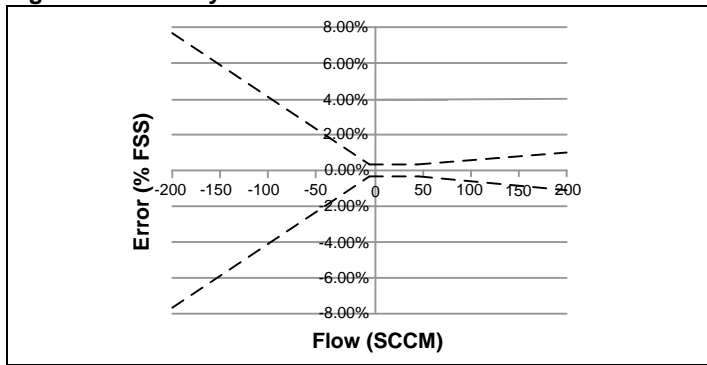

Figure 5. Total Error Band

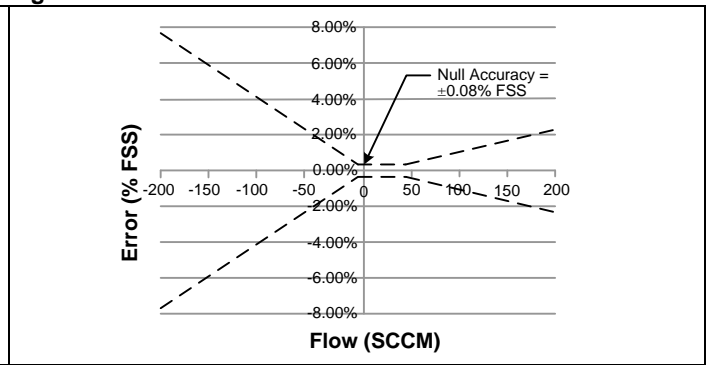
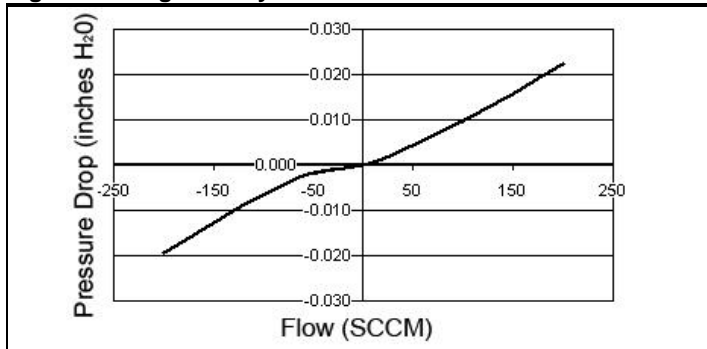
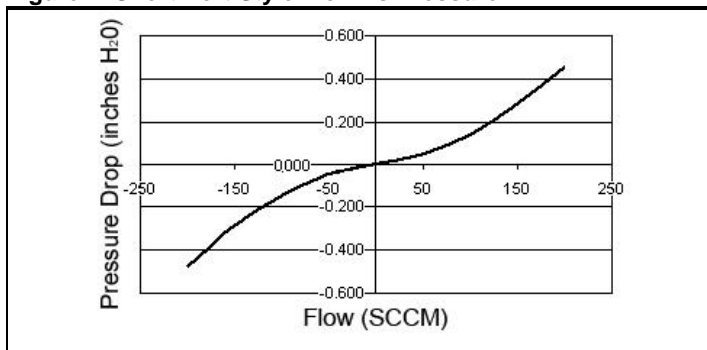

Figure 6. Long Port Style Flow vs Pressure



Flow (SCCM)	Typical Pressure Drop		
	in H ₂ O	mBar	kPa
-200	-0.019	-0.047	-0.005
-150	-0.013	-0.032	-0.003
-100	-0.007	-0.017	-0.002
-50	-0.001	-0.002	0.000
0	0.000	0.000	0.000
50	0.005	0.012	0.001
100	0.010	0.025	0.002
150	0.016	0.040	0.004
200	0.022	0.055	0.005

Figure 7 Short Port Style Flow vs Pressure



Flow (SCCM)	Typical Pressure Drop		
	in H ₂ O	mBar	kPa
-200	-0.470	-1.171	-0.117
-150	-0.284	-0.707	-0.071
-100	-0.143	-0.356	-0.036
-50	-0.045	-0.112	-0.011
0	0.000	0.000	0.000
50	0.048	0.120	0.012
100	0.139	0.346	0.035
150	0.287	0.715	0.071
200	0.452	1.126	0.113

HAF Series-High Accuracy

Figure 8. Wave Solder Profile

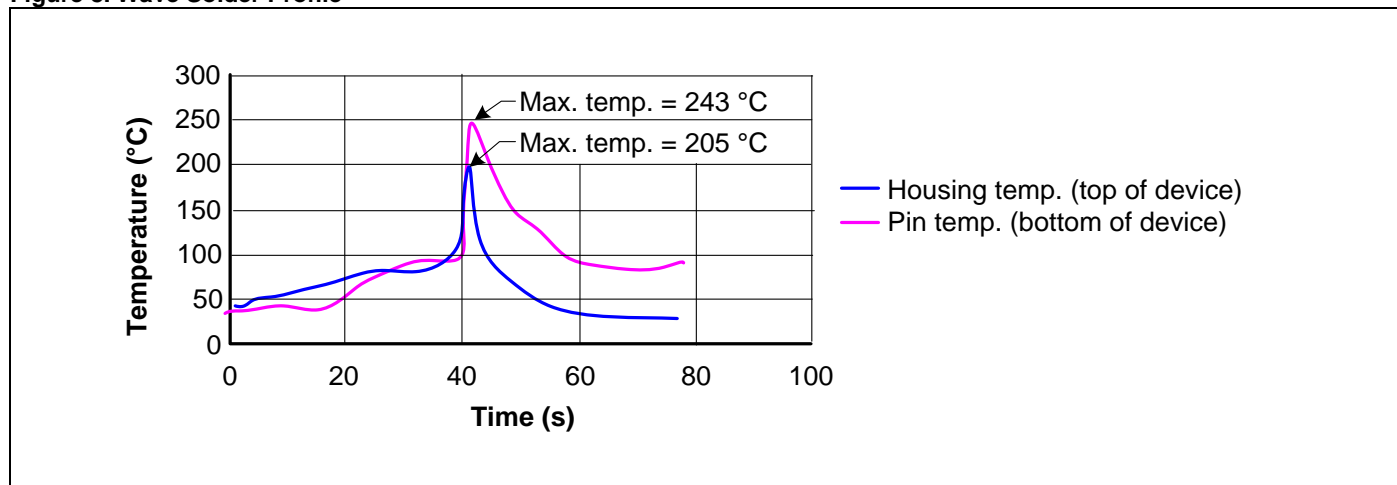
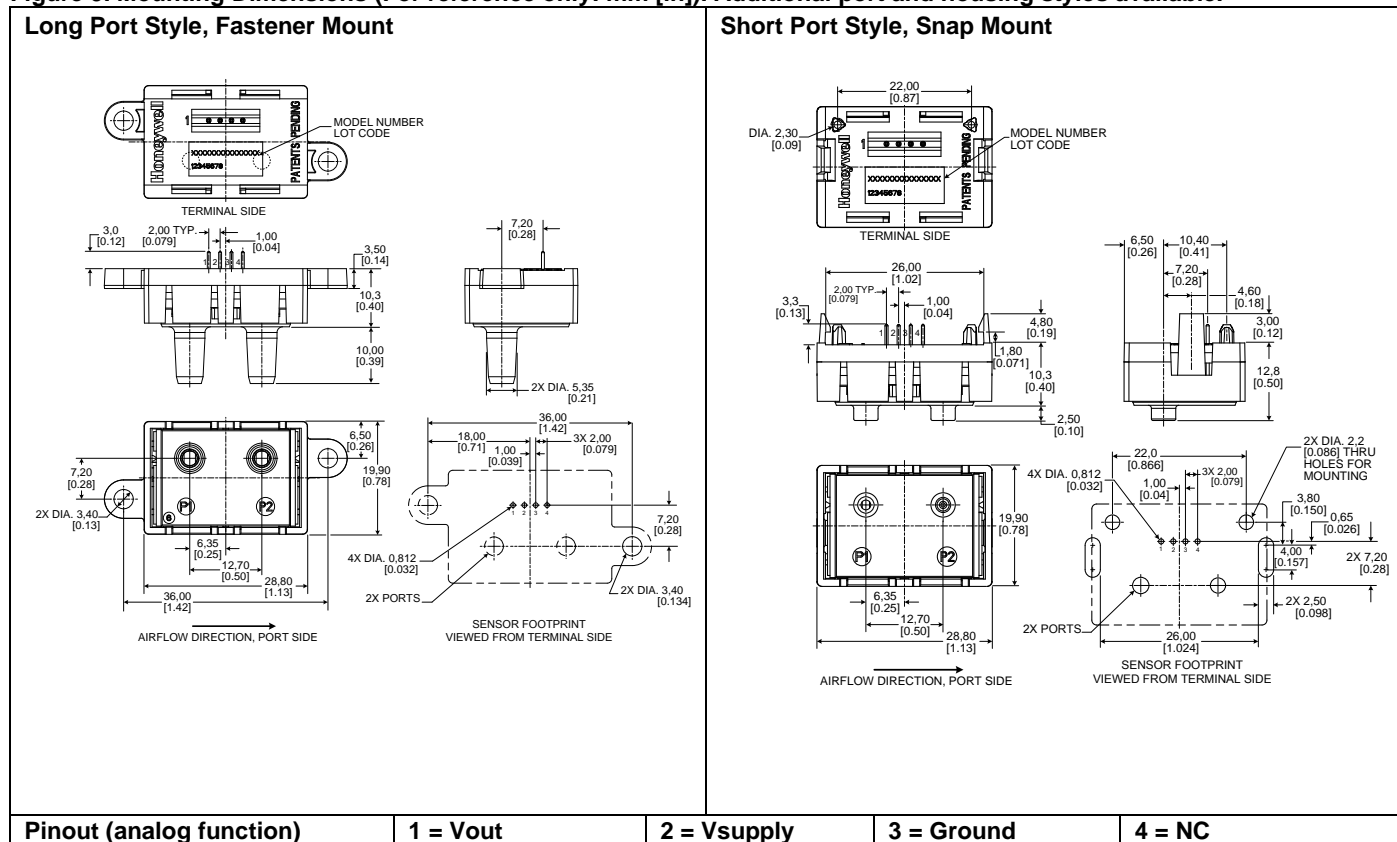

Figure 9. Mounting Dimensions (For reference only: mm [in]). Additional port and housing styles available.



WARNING

PERSONAL INJURY

DO NOT USE these products as safety or emergency stop devices or in any other application where failure of the product could result in personal injury.

Failure to comply with these instructions could result in death or serious injury.

WARRANTY/REMEDY

Honeywell warrants goods of its manufacture as being free of defective materials and faulty workmanship. Honeywell's standard product warranty applies unless agreed to otherwise by Honeywell in writing; please refer to your order acknowledgement or consult your local sales office for specific warranty details. If warranted goods are returned to Honeywell during the period of coverage, Honeywell will repair or replace, at its option, without charge those items it finds defective. **The foregoing is buyer's sole remedy and is in lieu of all other warranties, expressed or implied, including those of merchantability and fitness for a particular purpose. In no event shall Honeywell be liable for consequential, special, or indirect damages.**

While we provide application assistance personally, through our literature and the Honeywell web site, it is up to the customer to determine the suitability of the product in the application.

Specifications may change without notice. The information we supply is believed to be accurate and reliable as of this printing. However, we assume no responsibility for its use.

WARNING

MISUSE OF DOCUMENTATION

- The information presented in this product sheet is for reference only. Do not use this document as a product installation guide.
- Complete installation, operation, and maintenance information is provided in the instructions supplied with each product.

Failure to comply with these instructions could result in death or serious injury.

SALES AND SERVICE

Honeywell serves its customers through a worldwide network of sales offices, representatives and distributors. For application assistance, current specifications, pricing or name of the nearest Authorized Distributor, contact your local sales office or:

E-mail: info.sc@honeywell.com

Internet: www.honeywell.com/sensing

Phone and Fax:

Asia Pacific	+65 6355-2828 +65 6445-3033 Fax
Europe	+44 (0) 1698 481481 +44 (0) 1698 481676 Fax
Latin America	+1-305-805-8188 +1-305-883-8257 Fax
USA/Canada	+1-800-537-6945 +1-815-235-6847 +1-815-235-6545 Fax

Sensing and Control
Honeywell
1985 Douglas Drive North
Golden Valley, MN 55422
www.honeywell.com

008217-1-EN IL50 GLO Printed in USA
November 2010
© 2010 Honeywell International Inc. All rights reserved.

Honeywell