

# Tactile Switch Key Top B32

## Key Top Designed Specially for Projected-plunger-type B3F, B3FS and B3W Switches

- Available in a wide range of colors and sizes.
- RoHS Compliant.

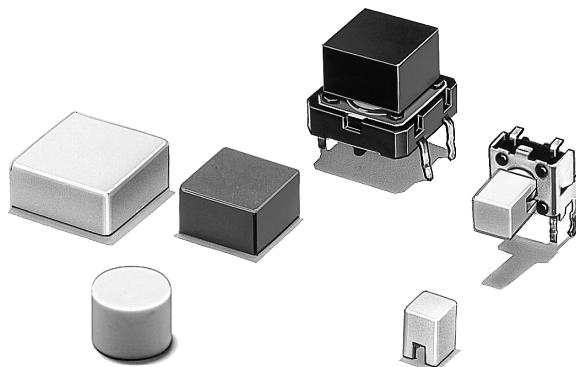

## Ordering Information

### For B3F, B3FS and B3W Switches

Color	6 x 6 mm Switches (B3F-1000, B3F-3000, B3F-6000, B3W-1000, B3FS)			12 x 12 mm Switches (B3F-4000, B3F-5000, B3W-4000)		
	4 x 4 mm Key Top	6 mm dia. Key Top	D-type Key Top	9 x 9 mm Key Top	12 x 12 mm Key Top	9.5-mm dia. Key Top
Light gray	B32-1000	B32-2000	B32-2100	B32-1200	B32-1300	B32-1600
Black	B32-1010	B32-2010	B32-2110	B32-1210	B32-1310	B32-1610
Orange	B32-1020	—	—	B32-1220	B32-1320	B32-1620
Yellow	B32-1030	—	—	B32-1230	B32-1330	B32-1630
Blue	B32-1040	—	—	B32-1240	B32-1340	—
White	B32-1060	—	—	B32-1260	B32-1360	—
Light green	B32-1070	—	—	B32-1270	B32-1370	—
Red	B32-1080	—	—	B32-1280	B32-1380	—

## Specifications

### ■ Characteristics

Ambient operating temperature	-25°C to 70°C (at 60% RH max.) with no icing or condensation
Ambient operating humidity	35% to 85% (at 5 to 35°C)

# Dimensions

Note: Unless otherwise specified, all units are in millimeters and a tolerance of  $\pm 0.4$  mm applies to all dimensions.

## ■ For 6 x 6 mm Tactile Switch

### B32-10□0

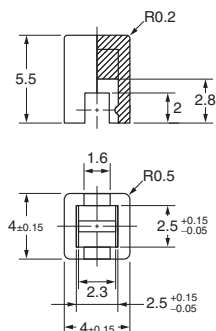

Reference Dimensions

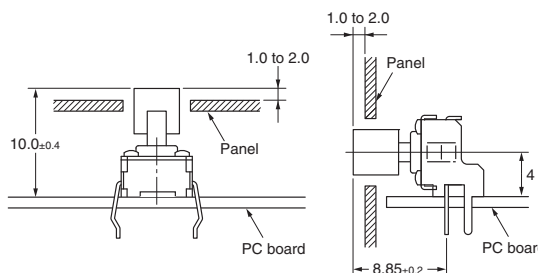

Panel Cutout

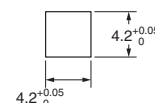

### B32-2000 B32-2010

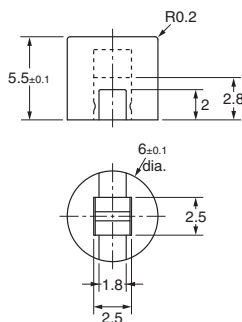

Reference Dimensions

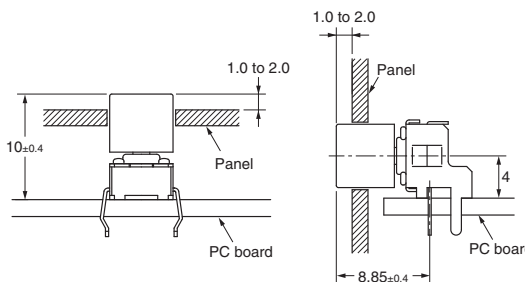

Panel Cutout

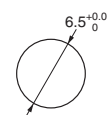

### B32-2100 B32-2110

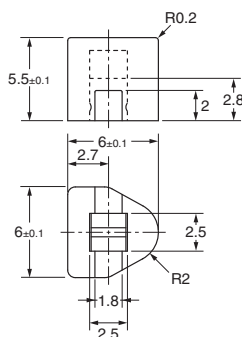

Reference Dimensions

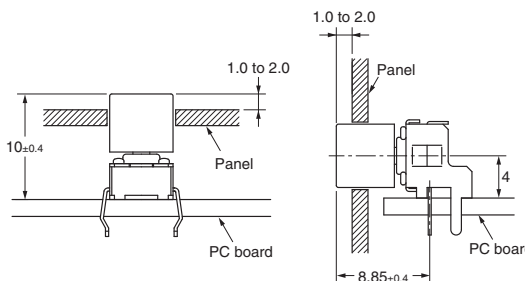

Panel Cutout

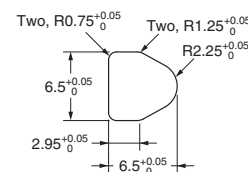

■ For 12 x 12 mm Tactile Switch

**B32-12**□0

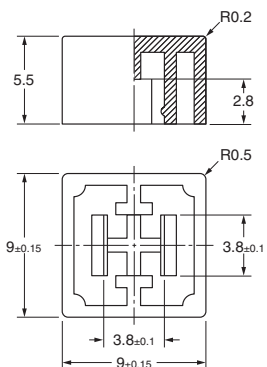

Reference Dimensions

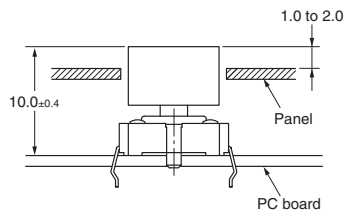

Panel Cutout

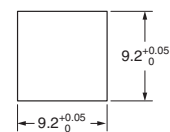

**B32-13**□0

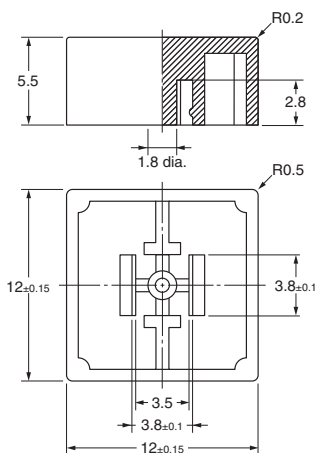
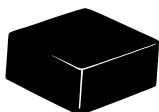

Reference Dimensions

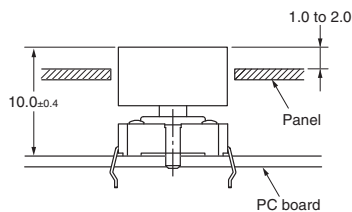

Panel Cutout

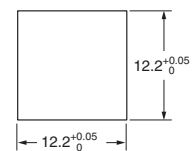

**B32-16**□0

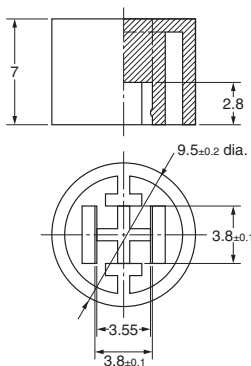

Reference Dimensions

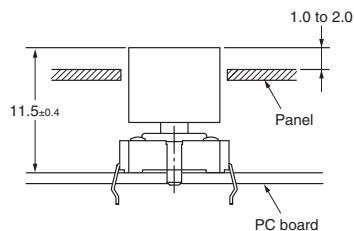

Panel Cutout

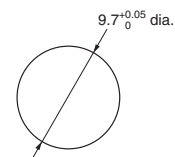

All sales are subject to Omron Electronic Components LLC standard terms and conditions of sale, which can be found at [http://www.components.omron.com/components/web/webfiles.nsf/sales\\_terms.html](http://www.components.omron.com/components/web/webfiles.nsf/sales_terms.html)

**ALL DIMENSIONS SHOWN ARE IN MILLIMETERS.**  
To convert millimeters into inches, multiply by 0.03937. To convert grams into ounces, multiply by 0.03527.

---

**OMRON**<sup>®</sup>

**OMRON ELECTRONIC  
COMPONENTS LLC**

55 E. Commerce Drive, Suite B  
Schaumburg, IL 60173

**847-882-2288**

**OMRON ON-LINE**

Global - <http://www.omron.com>

USA - <http://www.components.omron.com>

Cat. No. X303-E-1

11/10

Specifications subject to change without notice

Printed in USA

---

Tactile Switch Key Top **B32**