

LTIG-Series



The LTIG-Series Tippette rocker switches are lighted, double pole and AC rated up to 26 amps. A variety of circuits, colors, terminations and lamp voltages are available.

Specifications

- Certifications*: UL, CSA
- Dielectric Strength: 1,000V (minimum)
- Insulation Resistance: 100 Megohms (minimum)
- Base Material: Phenolic
- Actuator Material: Nylon
- Bezel Material: Nylon or Steel

* Due to ongoing technological advances, consult factory for certification specifics.

Dimensional Specifications: in. [mm]

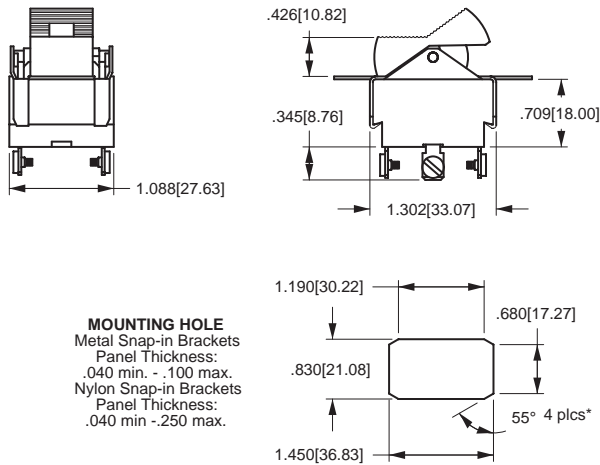

SOLDER LUG	.250 TAB (Q.C.)	.187 TAB (Q.C.)
TERMINAL TYPE		
SCREW (ASSEMBLED)	WIRE LEAD	PRINTED CIRCUIT

* Angled corners are suggested for optimum fit. Standard rectangular cutout is acceptable.

LTIG K 5 1 - 6S - BL - RC - NBL / 125N

SERIES

LTIG DOUBLE POLE LIGHTED

CIRCUIT¹

- K** ON-NONE-OFF
- L** ON-NONE-ON
- M** ON-OFF-ON

NOTES:

Shading indicates standard configurations.

Panel Cut-Out Recommendations: For sheet metal panels, switch must enter panel in same direction as the punch. (Burr on bottom.) Test cut hole in actual material.

- Lighted circuits L and M have two lamps.
- Additional non-inductive ratings to 26 amps available. Consult factory.
- Imprinting available on smooth face rockers. Other actuator styles available. Consult factory.
- Glossy finish is standard. Custom colors are available. Consult factory.
- Green & blue not recommended w/ 125 volt or 250 volt neon lamp. For two different color lenses, please specify when ordering lens color. (ex.) RC/GN
- Barbs are available on FN style bracket to accommodate panel thickness of .062, .100, .125, .156 and .250. Specify after bracket selection. (ex.) FN/125
MBL, NBL & WBL brackets are molded in black. If white is desired, specify as MWH, NWH & WWH. FN and FW brackets have a nickel-plated finish. Additional finishes are available; specify as follows: stainless steel: FN/SS; chrome: FN/CHP; black oxide: FW/BLK. FW bracket not available in stainless steel. Bracket style MBL consists of LNP rocker, neoprene seal, syntech grease, dummy rivets.
MBL, NBL and WBL brackets supplied in two pole base. All other brackets supplied in three pole base.
MBL does not have UL & CSA approvals.
- Actuator & Bracket Finish is a matched set.

RATING²

- 5** 10A 250VAC
15A 125VAC
3/4HP 250VAC
- 6** 3A 250VAC
6A 125VAC
1/4HP 125-250VAC

ACTUATOR STYLE³

- 1C** CROSS SERRATED
- 1L** LONG LINED
- 1S** SMOOTH ANGLED
- 6M⁷** MATTE CURVED (M, N OR W BRACKETS ONLY)
- 6S** SMOOTH CURVED (M, N & W BRACKETS ONLY)

TERMINATION/FUNCTION

FUNCTION	SOLDER LUG	.250 TAB (Q.C.)	.187 TAB (Q.C.)	SCREW TERM.	WIRE LEAD	PC TERM.
ON-NONE-OFF	0	1	3	4	5	6
(ON)-NONE-OFF	A	B	D	E	F	G
ON-NONE-(OFF)	L	M	R	S	T	U
ON-NONE-ON	0	1	3	4	5	6
ON-NONE-(ON)	A	B	D	E	F	G
ON-OFF-ON	0	1	3	4	5	6
ON-OFF-(ON)	A	B	D	E	F	G
(ON)-OFF-(ON)	L	M	R	S	T	U

ACTUATOR COLOR⁴

- BL** BLACK
- WH** WHITE

LENS COLOR⁵

- AM** AMBER
- CL** CLEAR
- GN** GREEN
- LU** BLUE
- RC** RED
- WH** WHITE

BRACKET STYLE⁶

- A**
- C**
- FN** NARROW
- FW** WIDE
- MBL** MARINE
- NBL**
- WBL** WATERSHEDDING

LAMP VOLTAGE

- 6V** 6 VOLT/ INCANDESCENT
- 12V** 12 VOLT/ INCANDESCENT
- 18V** 18 VOLT/ INCANDESCENT
- 24V** 24 VOLT/ INCANDESCENT
- 28V** 28 VOLT/ INCANDESCENT
- 125N** 125 VOLT/ NEON
- 250N** 250 VOLT/ NEON

Actuator Style/Dimensions: in. [mm]

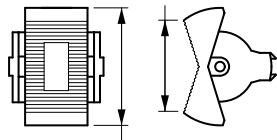

1C
CROSS-LINE W/ONE LENS

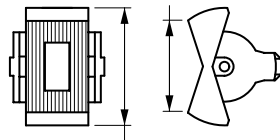

1L
LONG-LINE W/ONE LENS

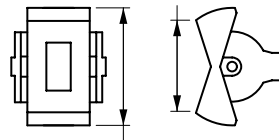

1S
SMOOTH W/ONE LENS

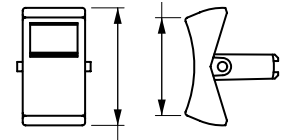

6S
CURVED W/ONE LENS

Bracket Dimensions: in. [mm]

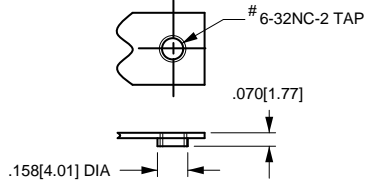

TAPPED HOLE
Standard with
A Bracket

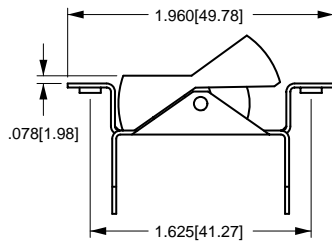

A

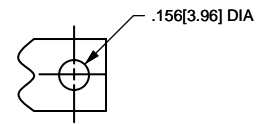

CLEARANCE HOLE
Standard with
C Bracket

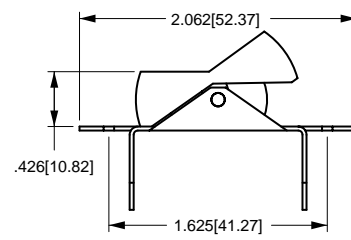

C

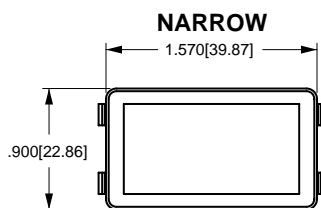
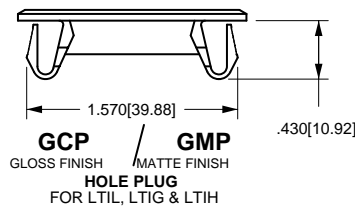
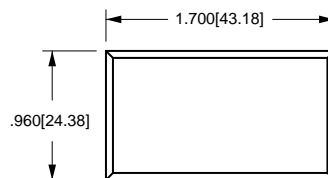

FN
METAL, SNAP-IN

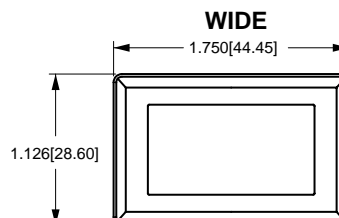

FW
METAL, SNAP-IN

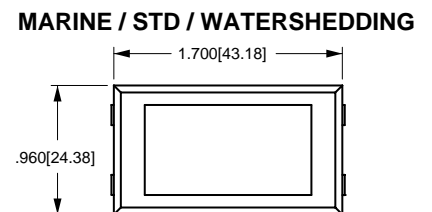

MBL, NBL, WBL
BLACK NYLON, SNAP-IN