



SERIES MDP-16 SWITCHES

PUSHBUTTON SWITCHES - MODULAR



SPECIFICATIONS

Contact Rating:	5A, 250VAC; 8A, 125VAC UL and VDE
Life Expectancy (Mechanical):	50,000 cycles
Life Expectancy (Electrical):	6,000 cycles
Contact Resistance:	100mΩ (initial max)
Insulation Resistance:	50MΩ @ 100V min.
Dielectric Strength:	2000VDC
Actuation Force:	500 grams SPDT 800 grams DPDT
Operating Temperature:	-25°C to 55°C
Storage Temperature:	-40°C to 70°C

FEATURES & BENEFITS

- ▶ Modular interface design
- ▶ Attractive front panel design
- ▶ Illuminated options available
- ▶ Robust product for industrial applications

APPLICATIONS/MARKETS

- ▶ Industrial controls
- ▶ Instrumentation
- ▶ Transportation
- ▶ Telecommunications

HOW TO ORDER

SERIES	FUNCTION STYLE	ACTUATOR CONFIGURATION	ACTUATOR STYLE	CIRCUIT CONFIGURATION	LAMP	ACTUATOR COLOR
MDP-16	EE = Latching OA = Momentary	R = Round S = Square T = Rectangular	1 = Low Bezel 2 = High Bezel 3 = Flush Mount 5 = Full Guard*	1 = SPDT 2 = DPDT	00 = None 01 = 6VAC Incandescent 02 = 14VAC Incandescent 03 = 28VAC Incandescent 04 = 48VAC Incandescent 05 = 60VAC Incandescent 06 = 48VDC Incandescent 07 = Neon 110VAC 08 = Neon 220VAC 09 = LED 6VDC 10 = LED 12VDC 11 = LED 24VDC	R = Red B = Blue G = Green O = Orange Y = Yellow W = White

* Note: Only offered in square

▶ ▶ ▶ **Example Ordering Number**
MDP-16-OA-S-5-2-09-R

Specifications subject to change without notice.

TACT SWITCHES

NAVIGATION SWITCHES

PUSHBUTTON SWITCHES

TOGGLE SWITCHES

ROCKER SWITCHES

SLIDE SWITCHES

SNAP-ACTION SWITCHES

DIP SWITCHES

KEYLOCK SWITCHES

ROTARY SWITCHES

DETECTOR SWITCHES

CAP OPTIONS

SERIES MDP-16 SWITCHES

PUSHBUTTON SWITCHES - MODULAR

LOW BEZEL ACTUATOR STYLE

RECTANGULAR

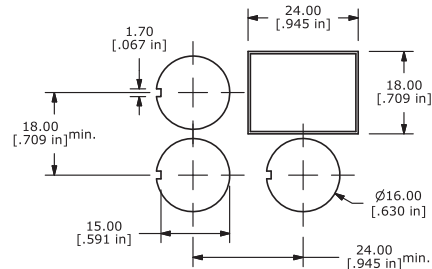
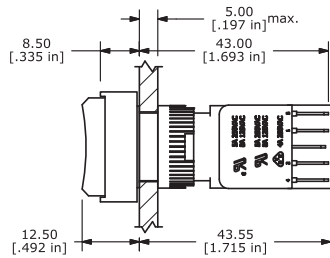
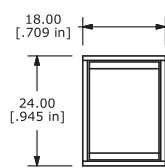

SQUARE

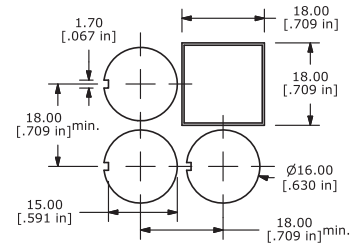
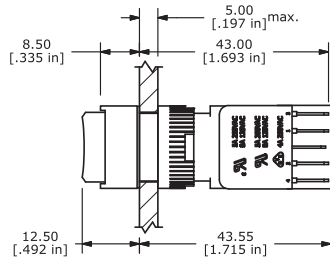
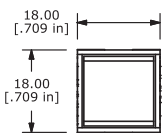

ROUND

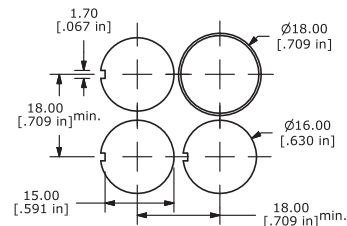
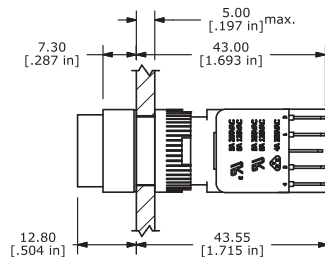
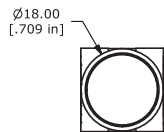

HIGH BEZEL ACTUATOR STYLE

RECTANGULAR

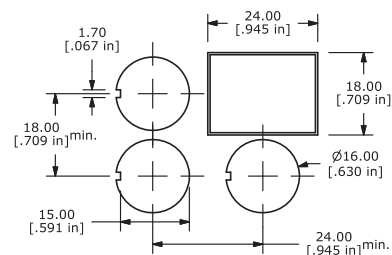
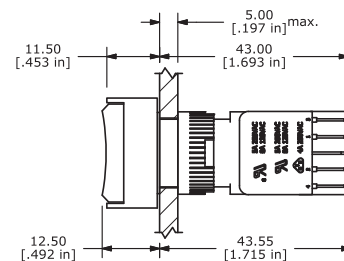
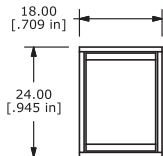

SQUARE

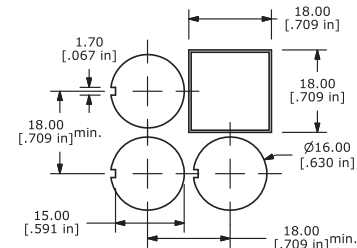
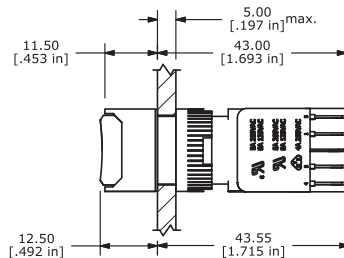
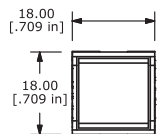

ROUND

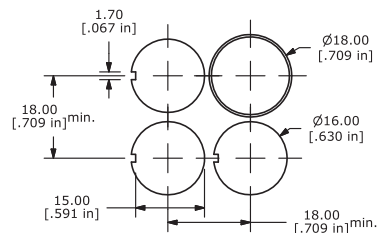
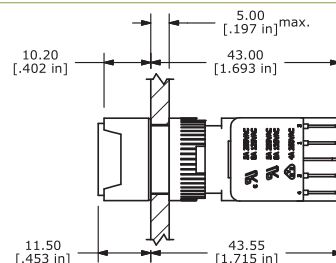
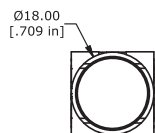

TACT SWITCHES

NAVIGATION SWITCHES

PUSHBUTTON SWITCHES

TOGGLE SWITCHES

ROCKER SWITCHES

SLIDE SWITCHES

SNAP-ACTION SWITCHES

DIP SWITCHES

KEYLOCK SWITCHES

ROTARY SWITCHES

DETECTOR SWITCHES

CAP OPTIONS



FLUSH MOUNT ACTUATOR STYLE

RECTANGULAR

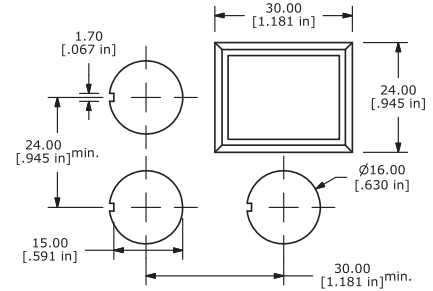
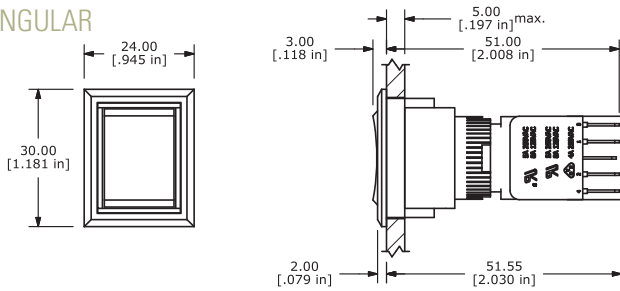

SQUARE

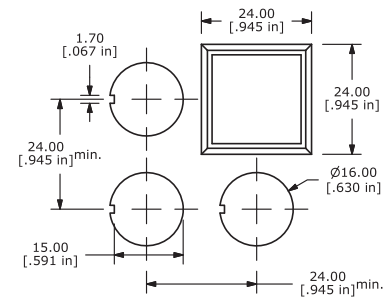
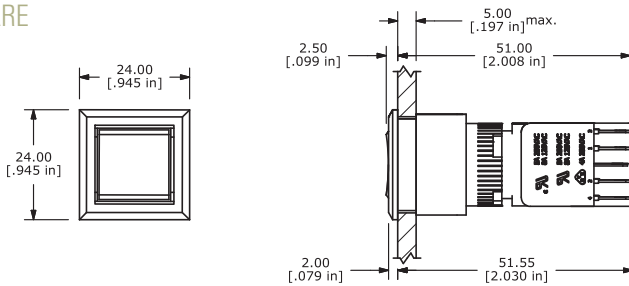

ROUND

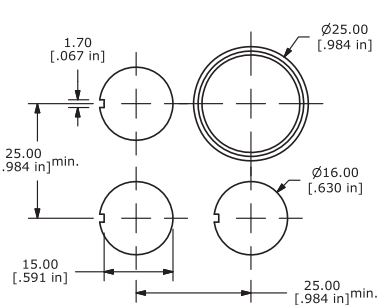
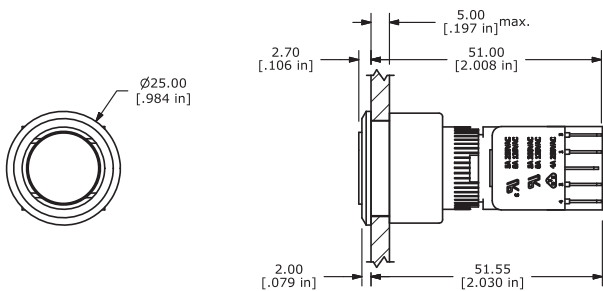

FULL GUARD ACTUATOR STYLE

SQUARE

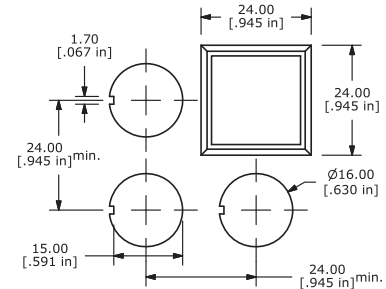
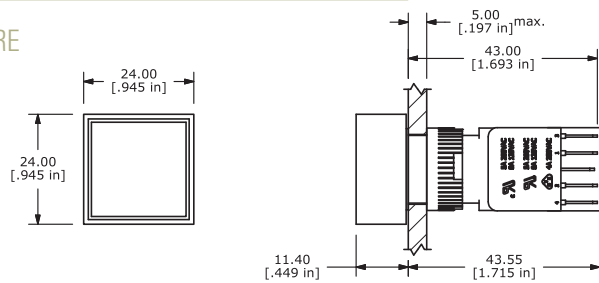

SCHEMATIC

SPDT

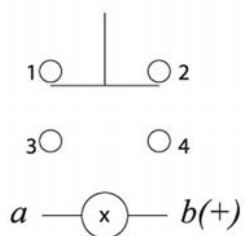

DPDT

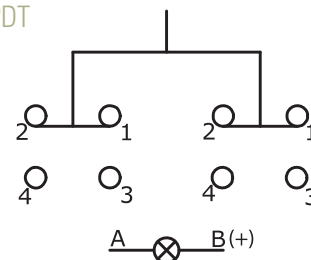

TACT SWITCHES

NAVIGATION SWITCHES

PUSHBUTTON SWITCHES

TOGGLE SWITCHES

ROCKER SWITCHES

SLIDE SWITCHES

SNAP-ACTION SWITCHES

DIP SWITCHES

KEYLOCK SWITCHES

ROTARY SWITCHES

DETECTOR SWITCHES

CAP OPTIONS