

Dimensions: mm (In.)

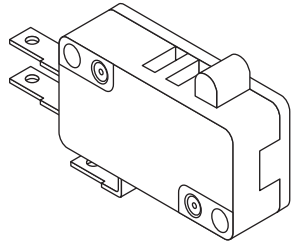

MOUNTING HOLES

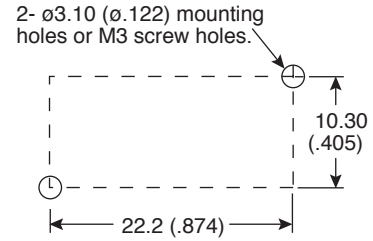

CONTACT CONFIGURATION

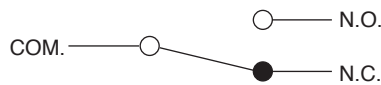

OPERATING CHARACTERISTICS

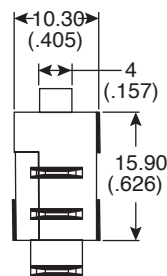
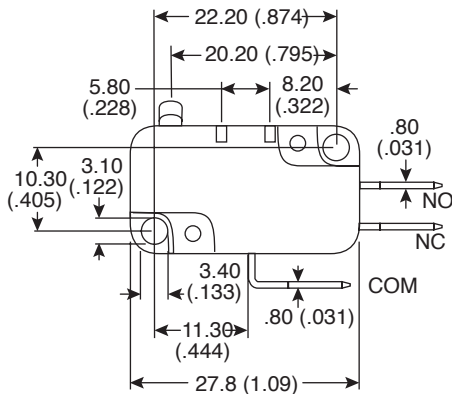
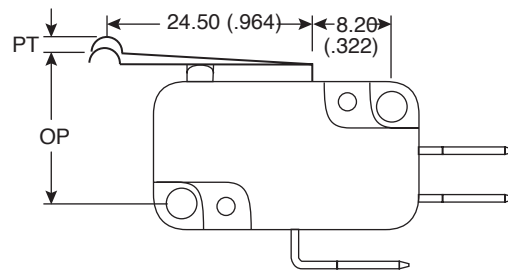

TERMINAL TYPES

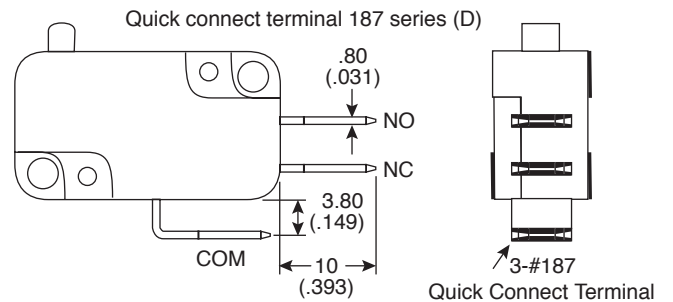

Electrical Specifications:

- Rating: 16A/125-250VAC
- Insulation Resistance (at 500VDC): 100M $\Omega$  Min.
- Dielectric Strength: 1,000VAC RMS(50-60HZ)
- Contact Resistance (Initial): 30m $\Omega$  Max.
- Electrical Operating Frequency: 10-30 operations/min.
- Operating Speed: 0.1mm to 1m/sec.
- Electrical Life: 6,000~100,000 operations(Min.)

Mechanical Specifications:

- Mechanical Operating Frequency: 300 operations/min.
- Mechanical Life: 5,000,000 operations(Min.)

Note:

- RoHS compliant and process compatible with 260° solder.

Operating Characteristics:

- OF (g) max: 190
- OP (mm): 18.4 $\pm$ 1.3
- PT max: 4.30mm
- OT min (mm): 0.90
- MD max (mm): 2.40

Miniature Snap Switch  
101-73-16-190SR-EV



Available from Mouser Electronics

www.mouser.com

1-800-346-6873