

Miniature Basic Switch D3V

Reliable Basic Switch with External Lever

- Available by 0.1 A, 6 A, 11 A, 16 A and 21 A models, all with self-cleaning contacts. 0.1 A utilizes gold alloy crossbar contacts for high reliability at low loads.
- Available with internally or externally fitted levers, and 2 fixing positions for external levers.
- Conforms to EN61058-1 UL1054.
- High Temperature models rated up to 200°C (D3V-6, D3V-01) and 155°C (D3V-11) are available.
- RoHS Compliant.



Ordering Information

Model Number Legend

D3V - - - - -

1 2 3 4 5 6 7 8 9 10

1. Ratings

- 21: 20 (4) A at 250 VAC
- 16: 16 (3) A at 250 VAC
- 11: 11 (3) A at 250 VAC
- 6: 6 (2) A at 250 VAC
- 01: 0.1 A at 125 VAC

2. Contact Gap

- None: 1 mm (F gap)
- G: 0.5 mm (G gap)

3. Actuator

- None: Pin plunger
- 1: Short hinge lever
- 2: Hinge lever
- 3: Long hinge lever
- 4: Simulated roller lever
- 5: Short hinge roller lever
- 6: Hinge roller lever

4. Hinge Position

- None: Internal / Far from Plunger
- M: External / Far from Plunger
- K: External / Near Plunger

5. Contact Form

- 1: SPDT
- 2: SPST-NC
- 3: SPST-NO

6. Terminals

- A: Solder terminals
- C2: Quick-connect terminal (#187)
- C: Quick-connect terminal (#250)
- C6: RAST5 terminal (#250)

7. Maximum Operating Force

- 5: 200 gf
- 4A: 125 gf
- 4: 100 gf
- 3: 50 gf
- 2: 25 gf

Note: These OF values are for the pin plunger models.

8. Enclosure Material

- None: Standard
- T: High Temperature
200°C for D3V-6, D3V-01
155°C for D3V-11

W2: EN60695-2-11/-12 Approved
(Glow wire flammability test method with PTI = 250)

9. Mounting Hole Size

- None: 3.1 mm
- K: 2.9 mm

10. Special Code

- None: Standard
- H: High Temperature (125°C)
- E: Special Rating: 21 (8) A
(D3V-21, only)







Available Combinations

| Heat resistance | Terminals | Model | D3V-16 | | | D3V-11 | | | D3V-6 | | | D3V-01 | | | | |
|------------------------------------|-----------|---------------|-------------|--------------------------|--------------------------|-----------|-------------|-----------|-------------|-------------|--------------------------|-----------|-------------|-------------|--------------------------|---|
| | | Rated current | 16 A | | | 11 A | | | 6 A | | | 0.1 A | | | | |
| | | OF | 200 gf | 100 gf | | 200 gf | 100 gf | 50 gf | 200 gf | 100 gf | 50 gf | 50 gf | 25 gf | | | |
| | | Contact gap | G 0.5 mm | F/G 1 mm or 0.5 mm | F/G 1 mm or 0.5 mm | F 1 mm | G 0.5 mm | F 1 mm | G 0.5 mm | G 0.5 mm | F/G 1 mm or 0.5 mm | F 1 mm | G 0.5 mm | G 0.5 mm | F/G 1 mm or 0.5 mm | |
| Standard (85°C) | #187 | | | | | | | | | | | | | ○ | ○ | |
| | #250 | ○ | | | | | | | | | | | | | ○ | ○ |
| | RAST5 | | | | | | | | | | | | | | ○ | ○ |
| Standard (105°C) | #187 | | ○ | ○ | ○ | ○ | ○ | ○ | ○ | ○ | ○ | ○ | ○ | | | |
| | #250 | | ○ | ○ | ○ | ○ | ○ | ○ | ○ | ○ | ○ | ○ | ○ | | | |
| | RAST5 | | | | | | | | ○ | | | ○ | | | | |
| EN60695-2-11 approved W2: 85°C | #187 | | | | | | | | | | | | | ○ | ○ | |
| | #250 | | | | | | | | | | | | | ○ | ○ | |
| | | | | | | | | | | | | | | ○ | ○ | |
| EN60695-2-11 approved W2: 105°C | #187 | | ○ | | | | | | | | | | | | | |
| | #250 | | ○ | ○ | ○ | | ○ | | | | ○ | | ○ | | | |
| | RAST5 | | | | | | | | ○ | | | | | | | |
| High temperature H: 125°C | #187 | | ○ | ○ | ○ | ○ | ○ | ○ | ○ | ○ | ○ | ○ | ○ | | | |
| | #250 | | ○ | ○ | ○ | ○ | ○ | ○ | ○ | ○ | ○ | ○ | ○ | | | |
| | RAST5 | | | | | | | | | | | | | | | |
| High temperature T: 155°C | #187 | | | | ○ | ○ | ○ | ○ | ○ | | | | | | | |
| | #250 | | | | ○ | ○ | ○ | ○ | ○ | | | | | | | |
| | RAST5 | | | | | | | | ○ | | | | | | | |
| High temperature T: 200°C | #187 | | | | | | | | | ○ | ○ | ○ | ○ | ○ | ○ | ○ |
| | #250 | | | | | | | | | ○ | ○ | ○ | ○ | ○ | ○ | ○ |
| | RAST5 | | | | | | | | | | | ○ | ○ | ○ | ○ | ○ |







Note: 1. ○: Available model.
2. Consult OMRON for specific models with standard approval.

List of Models







21 A (OF: 125 gf)

| Actuator | Hinge position (far from plunger) | Contact form | | |
|--|--------------------------------------|--------------------|--------------------|--------------------|
| | | SPDT | SPST-NC | SPST-NO |
| Pin plunger  | --- | D3V-21G-1□4A-D-Ñ | D3V-21G-2□4A-D-Ñ | D3V-21G-3□4A-D-Ñ |
| Short hinge lever  | Internal | D3V-21G1-1□4A-D-Ñ | D3V-21G1-2□4A-D-Ñ | D3V-21G1-3□4A-D-Ñ |
| | External (M) | D3V-21G1M-1□4A-D-Ñ | D3V-21G1M-2□4A-D-Ñ | D3V-21G1M-3□4A-D-Ñ |
| Hinge lever  | Internal | D3V-21G2-1□4A-D-Ñ | D3V-21G2-2□4A-D-Ñ | D3V-21G2-3□4A-D-Ñ |
| | External (M) | D3V-21G2M-1□4A-D-Ñ | D3V-21G2M-2□4A-D-Ñ | D3V-21G2M-3□4A-D-Ñ |
| Long hinge lever  | Internal | D3V-21G3-1□4A-D-Ñ | D3V-21G3-2□4A-D-Ñ | D3V-21G3-3□4A-D-Ñ |
| | External (M) | D3V-21G3M-1□4A-D-Ñ | D3V-21G3M-2□4A-D-Ñ | D3V-21G3M-3□4A-D-Ñ |
| Simulated roller lever  | Internal | D3V-21G4-1□4A-D-Ñ | D3V-21G4-2□4A-D-Ñ | D3V-21G4-3□4A-D-Ñ |
| | External (M) | D3V-21G4M-1□4A-D-Ñ | D3V-21G4M-2□4A-D-Ñ | D3V-21G4M-3□4A-D-Ñ |
| Short hinge roller lever  | Internal | D3V-21G5-1□4A-D-Ñ | D3V-21G5-2□4A-D-Ñ | D3V-21G5-3□4A-D-Ñ |
| | External (M) | D3V-21G5M-1□4A-D-Ñ | D3V-21G5M-2□4A-D-Ñ | D3V-21G5M-3□4A-D-Ñ |
| Hinge roller lever  | Internal | D3V-21G6-1□4A-D-Ñ | D3V-21G6-2□4A-D-Ñ | D3V-21G6-3□4A-D-Ñ |
| | External (M) | D3V-21G6M-1□4A-D-Ñ | D3V-21G6M-2□4A-D-Ñ | D3V-21G6M-3□4A-D-Ñ |







16 A (OF: 200 gf)

| Actuator | Hinge position (far from plunger) | Contact form | | |
|--|-----------------------------------|--------------------|--------------------|--------------------|
| | | SPDT | SPST-NC | SPST-NO |
| Pin plunger  | --- | D3V-16-1□5-●-D-Ñ | D3V-16-2□5-●-D-Ñ | D3V-16-3□5-●-D-Ñ |
| Short hinge lever  | Internal | D3V-161-1□5-●-D-Ñ | D3V-161-2□5-●-D-Ñ | D3V-161-3□5-●-D-Ñ |
| | External (M) | D3V-161M-1□5-●-D-Ñ | D3V-161M-2□5-●-D-Ñ | D3V-161M-3□5-●-D-Ñ |
| Hinge lever  | Internal | D3V-162-1□5-●-D-Ñ | D3V-162-2□5-●-D-Ñ | D3V-162-3□5-●-D-Ñ |
| | External (M) | D3V-162M-1□5-●-D-Ñ | D3V-162M-2□5-●-D-Ñ | D3V-162M-3□5-●-D-Ñ |
| Long hinge lever  | Internal | D3V-163-1□5-●-D-Ñ | D3V-163-2□5-●-D-Ñ | D3V-163-3□5-●-D-Ñ |
| | External (M) | D3V-163M-1□5-●-D-Ñ | D3V-163M-2□5-●-D-Ñ | D3V-163M-3□5-●-D-Ñ |
| Simulated roller lever  | Internal | D3V-164-1□5-●-D-Ñ | D3V-164-2□5-●-D-Ñ | D3V-164-3□5-●-D-Ñ |
| | External (M) | D3V-164M-1□5-●-D-Ñ | D3V-164M-2□5-●-D-Ñ | D3V-164M-3□5-●-D-Ñ |
| Short hinge roller lever  | Internal | D3V-165-1□5-●-D-Ñ | D3V-165-2□5-●-D-Ñ | D3V-165-3□5-●-D-Ñ |
| | External (M) | D3V-165M-1□5-●-D-Ñ | D3V-165M-2□5-●-D-Ñ | D3V-165M-3□5-●-D-Ñ |
| Hinge roller lever  | Internal | D3V-166-1□5-●-D-Ñ | D3V-166-2□5-●-D-Ñ | D3V-166-3□5-●-D-Ñ |
| | External (M) | D3V-166M-1□5-●-D-Ñ | D3V-166M-2□5-●-D-Ñ | D3V-166M-3□5-●-D-Ñ |

16 A (OF: 100 gf)

| Actuator | Hinge position (far from plunger) | Contact form | | |
|--|-----------------------------------|--------------------|--------------------|--------------------|
| | | SPDT | SPST-NC | SPST-NO |
| Pin plunger  | --- | D3V-16-1□4-●-D-Ñ | D3V-16-2□4-●-D-Ñ | D3V-16-3□4-●-D-Ñ |
| Short hinge lever  | Internal | D3V-161-1□4-●-D-Ñ | D3V-161-2□4-●-D-Ñ | D3V-161-3□4-●-D-Ñ |
| | External (M) | D3V-161M-1□4-●-D-Ñ | D3V-161M-2□4-●-D-Ñ | D3V-161M-3□4-●-D-Ñ |
| Hinge lever  | Internal | D3V-162-1□4-●-D-Ñ | D3V-162-2□4-●-D-Ñ | D3V-162-3□4-●-D-Ñ |
| | External (M) | D3V-162M-1□4-●-D-Ñ | D3V-162M-2□4-●-D-Ñ | D3V-162M-3□4-●-D-Ñ |
| Long hinge lever  | Internal | D3V-163-1□4-●-D-Ñ | D3V-163-2□4-●-D-Ñ | D3V-163-3□4-●-D-Ñ |
| | External (M) | D3V-163M-1□4-●-D-Ñ | D3V-163M-2□4-●-D-Ñ | D3V-163M-3□4-●-D-Ñ |
| Simulated roller lever  | Internal | D3V-164-1□4-●-D-Ñ | D3V-164-2□4-●-D-Ñ | D3V-164-3□4-●-D-Ñ |
| | External (M) | D3V-164M-1□4-●-D-Ñ | D3V-164M-2□4-●-D-Ñ | D3V-164M-3□4-●-D-Ñ |
| Short hinge roller lever  | Internal | D3V-165-1□4-●-D-Ñ | D3V-165-2□4-●-D-Ñ | D3V-165-3□4-●-D-Ñ |
| | External (M) | D3V-165M-1□4-●-D-Ñ | D3V-165M-2□4-●-D-Ñ | D3V-165M-3□4-●-D-Ñ |
| Hinge roller lever  | Internal | D3V-166-1□4-●-D-Ñ | D3V-166-2□4-●-D-Ñ | D3V-166-3□4-●-D-Ñ |
| | External (M) | D3V-166M-1□4-●-D-Ñ | D3V-166M-2□4-●-D-Ñ | D3V-166M-3□4-●-D-Ñ |

11 A (OF: 200 gf)

| Actuator | Hinge position (far from plunger) | Contact form | | |
|--|-----------------------------------|--------------------|--------------------|--------------------|
| | | SPDT | SPST-NC | SPST-NO |
| Pin plunger  | --- | D3V-11-1□5-●-D-Ñ | D3V-11-2□5-●-D-Ñ | D3V-11-3□5-●-D-Ñ |
| Short hinge lever  | Internal | D3V-111-1□5-●-D-Ñ | D3V-111-2□5-●-D-Ñ | D3V-111-3□5-●-D-Ñ |
| | External (M) | D3V-111M-1□5-●-D-Ñ | D3V-111M-2□5-●-D-Ñ | D3V-111M-3□5-●-D-Ñ |
| Hinge lever  | Internal | D3V-112-1□5-●-D-Ñ | D3V-112-2□5-●-D-Ñ | D3V-112-3□5-●-D-Ñ |
| | External (M) | D3V-112M-1□5-●-D-Ñ | D3V-112M-2□5-●-D-Ñ | D3V-112M-3□5-●-D-Ñ |
| Long hinge lever  | Internal | D3V-113-1□5-●-D-Ñ | D3V-113-2□5-●-D-Ñ | D3V-113-3□5-●-D-Ñ |
| | External (M) | D3V-113M-1□5-●-D-Ñ | D3V-113M-2□5-●-D-Ñ | D3V-113M-3□5-●-D-Ñ |
| Simulated roller lever  | Internal | D3V-114-1□5-●-D-Ñ | D3V-114-2□5-●-D-Ñ | D3V-114-3□5-●-D-Ñ |
| | External (M) | D3V-114M-1□5-●-D-Ñ | D3V-114M-2□5-●-D-Ñ | D3V-114M-3□5-●-D-Ñ |
| Short hinge roller lever  | Internal | D3V-115-1□5-●-D-Ñ | D3V-115-2□5-●-D-Ñ | D3V-115-3□5-●-D-Ñ |
| | External (M) | D3V-115M-1□5-●-D-Ñ | D3V-115M-2□5-●-D-Ñ | D3V-115M-3□5-●-D-Ñ |
| Hinge roller lever  | Internal | D3V-116-1□5-●-D-Ñ | D3V-116-2□5-●-D-Ñ | D3V-116-3□5-●-D-Ñ |
| | External (M) | D3V-116M-1□5-●-D-Ñ | D3V-116M-2□5-●-D-Ñ | D3V-116M-3□5-●-D-Ñ |

- The □ in the model number is for the terminal code.
 A: Solder/quick-connect terminals (#187)
 C2: Quick-connect terminals (#187)
 C: Quick-connect terminals (#250)
 C6 RAST5 terminals (#250)
- The ● in the model number is for the enclosure material
 None: Standard
 T: High Temperature (200°C for D3V-6/01, 155°C for D3V-11)
 W2: EN60695-2-11/-12 conformity with PTI=250

- The Δ in the model number is for the mounting hole size.
 None: 3.1 mm
 K: 2.9 mm
- The ▽ in the model number is for the special code
 None: Standard
 H: High Temperature (125°C)
 E: Special rating of 21A (8)A (for D3V-21 only)

11 A (OF: 100 gf)

| Actuator | Hinge position (far from plunger) | Contact form | | |
|--|--------------------------------------|--------------------|--------------------|--------------------|
| | | SPDT | SPST-NC | SPST-NO |
| Pin plunger  | --- | D3V-11-1□4-●-D-Ñ | D3V-11-2□4-●-D-Ñ | D3V-11-3□4-●-D-Ñ |
| Short hinge lever  | Internal | D3V-111-1□4-●-D-Ñ | D3V-111-2□4-●-D-Ñ | D3V-111-3□4-●-D-Ñ |
| | External (M) | D3V-111M-1□4-●-D-Ñ | D3V-111M-2□4-●-D-Ñ | D3V-111M-3□4-●-D-Ñ |
| Hinge lever  | Internal | D3V-112-1□4-●-D-Ñ | D3V-112-2□4-●-D-Ñ | D3V-112-3□4-●-D-Ñ |
| | External (M) | D3V-112M-1□4-●-D-Ñ | D3V-112M-2□4-●-D-Ñ | D3V-112M-3□4-●-D-Ñ |
| Long hinge lever  | Internal | D3V-113-1□4-●-D-Ñ | D3V-113-2□4-●-D-Ñ | D3V-113-3□4-●-D-Ñ |
| | External (M) | D3V-113M-1□4-●-D-Ñ | D3V-113M-2□4-●-D-Ñ | D3V-113M-3□4-●-D-Ñ |
| Simulated roller lever  | Internal | D3V-114-1□4-●-D-Ñ | D3V-114-2□4-●-D-Ñ | D3V-114-3□4-●-D-Ñ |
| | External (M) | D3V-114M-1□4-●-D-Ñ | D3V-114M-2□4-●-D-Ñ | D3V-114M-3□4-●-D-Ñ |
| Short hinge roller lever  | Internal | D3V-115-1□4-●-D-Ñ | D3V-115-2□4-●-D-Ñ | D3V-115-3□4-●-D-Ñ |
| | External (M) | D3V-115M-1□4-●-D-Ñ | D3V-115M-2□4-●-D-Ñ | D3V-115M-3□4-●-D-Ñ |
| Hinge roller lever  | Internal | D3V-116-1□4-●-D-Ñ | D3V-116-2□4-●-D-Ñ | D3V-116-3□4-●-D-Ñ |
| | External (M) | D3V-116M-1□4-●-D-Ñ | D3V-116M-2□4-●-D-Ñ | D3V-116M-3□4-●-D-Ñ |

11 A (OF: 50 gf)

| Actuator | Hinge position (far from plunger) | Contact form | | |
|--|--------------------------------------|---------------------|---------------------|---------------------|
| | | SPDT | SPST-NC | SPST-NO |
| Pin plunger  | --- | D3V-11G-1□3-●-D-Ñ | D3V-11G-2□3-●-D-Ñ | D3V-11G-3□3-●-D-Ñ |
| Short hinge lever  | Internal | D3V-11G1-1□3-●-D-Ñ | D3V-11G1-2□3-●-D-Ñ | D3V-11G1-3□3-●-D-Ñ |
| | External (M) | D3V-11G1M-1□3-●-D-Ñ | D3V-11G1M-2□3-●-D-Ñ | D3V-11G1M-3□3-●-D-Ñ |
| Hinge lever  | Internal | D3V-11G2-1□3-●-D-Ñ | D3V-11G2-2□3-●-D-Ñ | D3V-11G2-3□3-●-D-Ñ |
| | External (M) | D3V-11G2M-1□3-●-D-Ñ | D3V-11G2M-2□3-●-D-Ñ | D3V-11G2M-3□3-●-D-Ñ |
| Long hinge lever  | Internal | D3V-11G3-1□3-●-D-Ñ | D3V-11G3-2□3-●-D-Ñ | D3V-11G3-3□3-●-D-Ñ |
| | External (M) | D3V-11G3M-1□3-●-D-Ñ | D3V-11G3M-2□3-●-D-Ñ | D3V-11G3M-3□3-●-D-Ñ |
| Simulated roller lever  | Internal | D3V-11G4-1□3-●-D-Ñ | D3V-11G4-2□3-●-D-Ñ | D3V-11G4-3□3-●-D-Ñ |
| | External (M) | D3V-11G4M-1□3-●-D-Ñ | D3V-11G4M-2□3-●-D-Ñ | D3V-11G4M-3□3-●-D-Ñ |
| Short hinge roller lever  | Internal | D3V-11G5-1□3-●-D-Ñ | D3V-11G5-2□3-●-D-Ñ | D3V-11G5-3□3-●-D-Ñ |
| | External (M) | D3V-11G5M-1□3-●-D-Ñ | D3V-11G5M-2□3-●-D-Ñ | D3V-11G5M-3□3-●-D-Ñ |
| Hinge roller lever  | Internal | D3V-11G6-1□3-●-D-Ñ | D3V-11G6-2□3-●-D-Ñ | D3V-11G6-3□3-●-D-Ñ |
| | External (M) | D3V-11G6M-1□3-●-D-Ñ | D3V-11G6M-2□3-●-D-Ñ | D3V-11G6M-3□3-●-D-Ñ |

6 A (OF: 100 gf)

| Actuator | Hinge position (far from plunger) | Contact form | | |
|--|--------------------------------------|-------------------|-------------------|-------------------|
| | | SPDT | SPST-NC | SPST-NO |
| Pin plunger  | --- | D3V-6-1□4-●-D-Ñ | D3V-6-2□4-●-D-Ñ | D3V-6-3□4-●-D-Ñ |
| Short hinge lever  | Internal | D3V-61-1□4-●-D-Ñ | D3V-61-2□4-●-D-Ñ | D3V-61-3□4-●-D-Ñ |
| | External (M) | D3V-61M-1□4-●-D-Ñ | D3V-61M-2□4-●-D-Ñ | D3V-61M-3□4-●-D-Ñ |
| Hinge lever  | Internal | D3V-62-1□4-●-D-Ñ | D3V-62-2□4-●-D-Ñ | D3V-62-3□4-●-D-Ñ |
| | External (M) | D3V-62M-1□4-●-D-Ñ | D3V-62M-2□4-●-D-Ñ | D3V-62M-3□4-●-D-Ñ |
| Long hinge lever  | Internal | D3V-63-1□4-●-D-Ñ | D3V-63-2□4-●-D-Ñ | D3V-63-3□4-●-D-Ñ |
| | External (M) | D3V-63M-1□4-●-D-Ñ | D3V-63M-2□4-●-D-Ñ | D3V-63M-3□4-●-D-Ñ |
| Simulated roller lever  | Internal | D3V-64-1□4-●-D-Ñ | D3V-64-2□4-●-D-Ñ | D3V-64-3□4-●-D-Ñ |
| | External (M) | D3V-64M-1□4-●-D-Ñ | D3V-64M-2□4-●-D-Ñ | D3V-64M-3□4-●-D-Ñ |
| Short hinge roller lever  | Internal | D3V-65-1□4-●-D-Ñ | D3V-65-2□4-●-D-Ñ | D3V-65-3□4-●-D-Ñ |
| | External (M) | D3V-65M-1□4-●-D-Ñ | D3V-65M-2□4-●-D-Ñ | D3V-65M-3□4-●-D-Ñ |
| Hinge roller lever  | Internal | D3V-66-1□4-●-D-Ñ | D3V-66-2□4-●-D-Ñ | D3V-66-3□4-●-D-Ñ |
| | External (M) | D3V-66M-1□4-●-D-Ñ | D3V-66M-2□4-●-D-Ñ | D3V-66M-3□4-●-D-Ñ |

• The □ in the model number is for the terminal code.

- A: Solder/quick-connect terminals (#187)
- C2: Quick-connect terminals (#187)
- C: Quick-connect terminals (#250)
- C6: RAST5 terminals (#250)

• The ● in the model number is for the enclosure material

- None: Standard
- T: High Temperature (200°C for D3V-6/-01, 155°C for D3V-11)
- W2: EN60695-2-11/-12 conformity with PTI=250







• The Δ in the model number is for the mounting hole size.

- None: 3.1 mm
- K: 2.9 mm







• The ▽ in the model number is for the special code

- None: Standard
- H: High Temperature (125°C)
- E: Special rating of 21A (8)A (for D3V-21 only)

6 A (OF: 50 gf)

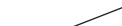
| Actuator | Hinge position (far from plunger) | Contact form | | |
|--|-----------------------------------|--------------------|--------------------|--------------------|
| | | SPDT | SPST-NC | SPST-NO |
| Pin plunger  | --- | D3V-6G-1□3-●-D-Ñ | D3V-6G-2□3-●-D-Ñ | D3V-6G-3□3-●-D-Ñ |
| Short hinge lever  | Internal | D3V-6G1-1□3-●-D-Ñ | D3V-6G1-2□3-●-D-Ñ | D3V-6G1-3□3-●-D-Ñ |
| | External (M) | D3V-6G1M-1□3-●-D-Ñ | D3V-6G1M-2□3-●-D-Ñ | D3V-6G1M-3□3-●-D-Ñ |
| Hinge lever  | Internal | D3V-6G2-1□3-●-D-Ñ | D3V-6G2-2□3-●-D-Ñ | D3V-6G2-3□3-●-D-Ñ |
| | External (M) | D3V-6G2M-1□3-●-D-Ñ | D3V-6G2M-2□3-●-D-Ñ | D3V-6G2M-3□3-●-D-Ñ |
| Long hinge lever  | Internal | D3V-6G3-1□3-●-D-Ñ | D3V-6G3-2□3-●-D-Ñ | D3V-6G3-3□3-●-D-Ñ |
| | External (M) | D3V-6G3M-1□3-●-D-Ñ | D3V-6G3M-2□3-●-D-Ñ | D3V-6G3M-3□3-●-D-Ñ |
| Simulated roller lever  | Internal | D3V-6G4-1□3-●-D-Ñ | D3V-6G4-2□3-●-D-Ñ | D3V-6G4-3□3-●-D-Ñ |
| | External (M) | D3V-6G4M-1□3-●-D-Ñ | D3V-6G4M-2□3-●-D-Ñ | D3V-6G4M-3□3-●-D-Ñ |
| Short hinge roller lever  | Internal | D3V-6G5-1□3-●-D-Ñ | D3V-6G5-2□3-●-D-Ñ | D3V-6G5-3□3-●-D-Ñ |
| | External (M) | D3V-6G5M-1□3-●-D-Ñ | D3V-6G5M-2□3-●-D-Ñ | D3V-6G5M-3□3-●-D-Ñ |
| Hinge roller lever  | Internal | D3V-6G6-1□3-●-D-Ñ | D3V-6G6-2□3-●-D-Ñ | D3V-6G6-3□3-●-D-Ñ |
| | External (M) | D3V-6G6M-1□3-●-D-Ñ | D3V-6G6M-2□3-●-D-Ñ | D3V-6G6M-3□3-●-D-Ñ |

01 A (OF: 50 gf)

| Actuator | Hinge position (far from plunger) | Contact form | | |
|--|-----------------------------------|--------------------|--------------------|--------------------|
| | | SPDT | SPST-NC | SPST-NO |
| Pin plunger  | --- | D3V-01-1□3-●-D-Ñ | D3V-01-2□3-●-D-Ñ | D3V-01-3□3-●-D-Ñ |
| Short hinge lever  | Internal | D3V-011-1□3-●-D-Ñ | D3V-011-2□3-●-D-Ñ | D3V-011-3□3-●-D-Ñ |
| | External (M) | D3V-011M-1□3-●-D-Ñ | D3V-011M-2□3-●-D-Ñ | D3V-011M-3□3-●-D-Ñ |
| Hinge lever  | Internal | D3V-012-1□3-●-D-Ñ | D3V-012-2□3-●-D-Ñ | D3V-012-3□3-●-D-Ñ |
| | External (M) | D3V-012M-1□3-●-D-Ñ | D3V-012M-2□3-●-D-Ñ | D3V-012M-3□3-●-D-Ñ |
| Long hinge lever  | Internal | D3V-013-1□3-●-D-Ñ | D3V-013-2□3-●-D-Ñ | D3V-013-3□3-●-D-Ñ |
| | External (M) | D3V-013M-1□3-●-D-Ñ | D3V-013M-2□3-●-D-Ñ | D3V-013M-3□3-●-D-Ñ |
| Simulated roller lever  | Internal | D3V-014-1□3-●-D-Ñ | D3V-014-2□3-●-D-Ñ | D3V-014-3□3-●-D-Ñ |
| | External (M) | D3V-014M-1□3-●-D-Ñ | D3V-014M-2□3-●-D-Ñ | D3V-014M-3□3-●-D-Ñ |
| Short hinge roller lever  | Internal | D3V-015-1□3-●-D-Ñ | D3V-015-2□3-●-D-Ñ | D3V-015-3□3-●-D-Ñ |
| | External (M) | D3V-015M-1□3-●-D-Ñ | D3V-015M-2□3-●-D-Ñ | D3V-015M-3□3-●-D-Ñ |
| Hinge roller lever  | Internal | D3V-016-1□3-●-D-Ñ | D3V-016-2□3-●-D-Ñ | D3V-016-3□3-●-D-Ñ |
| | External (M) | D3V-016M-1□3-●-D-Ñ | D3V-016M-2□3-●-D-Ñ | D3V-016M-3□3-●-D-Ñ |

01 A (OF: 25 gf)

| Actuator | Hinge position (far from plunger) | Contact form | | |
|---|-----------------------------------|------------------|------------------|------------------|
| | | SPDT | SPST-NC | SPST-NO |
| Pin plunger  | --- | D3V-01-1□2-●-D-Ñ | D3V-01-2□2-●-D-Ñ | D3V-01-3□2-●-D-Ñ |

- The □ in the model number is for the terminal code.
 - A: Solder/quick-connect terminals (#187)
 - C2: Quick-connect terminals (#187)
 - C: Quick-connect terminals (#250)
 - C6: RAST5 terminals (#250)
- The ● in the model number is for the enclosure material
 - None: Standard
 - T: High Temperature (200°C for D3V-6/-01, 155°C for D3V-11)
 - W2: EN60695-2-11/-12 conformity with PTI=250

- The Δ in the model number is for the mounting hole size.
 - None: 3.1 mm
 - K: 2.9 mm
- The ▽ in the model number is for the special code
 - None: Standard
 - H: High Temperature (125°C)
 - E: Special rating of 21A (8)A (for D3V-21 only)

Specifications

■ Ratings

| Type | Rated voltage | Non-inductive load | | | | Inductive load | | | |
|--------|---------------|--------------------|----|-----------|----|----------------|----|------------|----|
| | | Resistive load | | Lamp load | | Inductive load | | Motor load | |
| | | NC | NO | NC | NO | NC | NO | NC | NO |
| D3V-21 | 250 VAC | 21 A | | 3 A | | 12 A | | 4 A | |
| | 8 VDC | 21 A | | 5 A | | 12 A | | 7 A | |
| | 30 VDC | 14 A | | 5 A | | 12 A | | 5 A | |
| | 125 VDC | 0.6 A | | 0.1 A | | 0.6 A | | 0.1 A | |
| | 250 VDC | 0.3 A | | 0.05 A | | 0.3 A | | 0.05 A | |
| D3V-16 | 250 VAC | 16 A | | 2 A | | 10 A | | 3 A | |
| | 8 VDC | 16 A | | 4 A | | 10 A | | 6 A | |
| | 30 VDC | 10 A | | 4 A | | 10 A | | 4 A | |
| | 125 VDC | 0.6 A | | 0.1 A | | 0.6 A | | 0.1 A | |
| | 250 VDC | 0.3 A | | 0.05 A | | 0.3 A | | 0.05 A | |
| D3V-11 | 250 VAC | 11 A | | 1.5 A | | 6 A | | 2 A | |
| | 8 VDC | 11 A | | 3 A | | 6 A | | 3 A | |
| | 30 VDC | 6 A | | 3 A | | 6 A | | 3 A | |
| | 125 VDC | 0.6 A | | 0.1 A | | 0.6 A | | 0.1 A | |
| | 250 VDC | 0.3 A | | 0.05 A | | 0.3 A | | 0.05 A | |
| D3V-6 | 250 VAC | 6 A | | 3 A | | 4 A | | --- | |
| | 8 VDC | 6 A | | 3 A | | 4 A | | --- | |
| | 30 VDC | 6 A | | 3 A | | 4 A | | --- | |
| | 125 VDC | 0.4 A | | 0.1 A | | 0.4 A | | --- | |
| | 250 VDC | 0.3 A | | 0.05 A | | 0.2 A | | --- | |
| D3V-01 | 125 VAC | 0.1 A | | --- | | --- | | --- | |
| | 8 VDC | 0.1 A | | --- | | --- | | --- | |
| | 30 VDC | 0.1 A | | --- | | --- | | --- | |

Note: 1. The above current values are the normal current values of models with a contact gap of 1 mm (gap F), which vary with the normal current values of models with a contact gap of 0.5 mm (gap G).

2. Inductive load has a power factor of 0.4 min. (AC) and a time constant of 7 ms max. (DC).
3. Lamp load has an inrush current of 10 times the steady-state current.
4. Motor load has an inrush current of 6 times the steady-state current.
5. The ratings values apply under the following test conditions: Ambient temperature: 20±2°C, Ambient humidity: 65±5%, Operating frequency: 30 operations/min

■ Approved Standards

UL1054 (File No. E41515)

CSA C22.2 No.55 (File No. LR21642)

(Only standard ratings are listed.)

| Rated voltage | D3V-21G | D3V-16 | D3V-16G | D3V-11 | D3V-11G | D3V-6 | D3V-6G | D3V-01 |
|---------------|----------------|--------------|--------------|--------------|--------------|-------------|-------------|--------|
| 125 VAC | 3/4 HP | 16 A, 1/2 HP | 16 A, 1/2 HP | 11 A, 1/2 HP | 11 A, 1/2 HP | 6 A, 1/4 HP | 6 A, 1/4 HP | 0.1 A |
| 250 VAC | 20.1 A, 3/4 HP | 16 A, 1/2 HP | 16 A, 1/2 HP | 11 A, 1/2 HP | 11 A, 1/2 HP | 6 A, 1/4 HP | 6 A, 1/4 HP | --- |
| 125 VDC | --- | 0.6 A | 0.1 A | 0.6 A | 0.1 A | --- | --- | --- |
| 250 VDC | --- | 0.3 A | --- | 0.3 A | --- | --- | --- | --- |

EN 61058-1: 1992+A1: 1993 (License No. 119151L)

| Rated voltage | D3V-21G | D3V-16 | D3V-11 | D3V-6 | D3V-01 |
|---------------|------------|----------|----------|---------|--------|
| 125 VAC | --- | --- | --- | --- | 0.1 A |
| 250 VAC | 20 (4) A | 16 (3) A | 11 (3) A | 6 (2) A | --- |
| 250 VAC | 21 (8) A** | | | | |

Testing conditions: 50,000 operations, T85 (0°C to 85°C) for D3V-21/D3V-01, T105 (0°C to 105°C) for D3V-16/D3V-11/D3V-6 and T200 (0 to 200°C) for D3V-6/01 with suffix "T", T155 (0 to 155°C) for D3V-11 with suffix "T".

**Testing conditions: 10,000 operations, T85 (0°C to 85°C)

EN 60695-2-11 Ed.2, EN 60695-2-12 Ed.2 - - Glow-wire flammability test methods

| Rated voltage | D3V-16 | D3V-11 | D3V-6 | D3V-01 |
|---------------|----------|----------|---------|--------|
| 125 VAC | --- | --- | --- | 0.1 A |
| 250 VAC | 16 (3) A | 11 (3) A | 6 (2) A | --- |

■ Characteristics

| | |
|---|---|
| Operating speed | 0.1 mm to 1 m/s (plunger models) |
| Operating frequency | Mechanical: 600 operations/min Electrical: 60 operations/min |
| Insulation resistance | 100 MΩ min. (at 500 VDC) |
| Contact resistance | D3V-21: 50 mΩ max. D3V-16, D3V-11, D3V-6: 30 mΩ max. D3V-01, 50 gf versions: 50 mΩ max. 25 gf versions: 100 mΩ max. |
| Dielectric strength (see note 2) | 1,000 VAC, 50/60 Hz for 1 min between terminals of the same polarity 2,000 VAC, 50/60 Hz for 1 min between current-carrying metal parts and ground, and between each terminal and non-current-carrying metal parts |
| Vibration resistance (see note 3) | Malfunction: 10 to 55 Hz, 1.5-mm double amplitude |
| Shock resistance (see note 3) | Destruction: 400 m/s ² (approx. 40G) max. Malfunction: 100 m/s ² (approx. 10G) max. |
| Life expectancy | Mechanical: 10,000,000 operations min. Electrical: D3V-21: 50,000 operations min. D3V-16: 100,000 operations min. D3V-11: 200,000 operations min. D3V-6, D3V-01: 500,000 operations min. |
| Degree of protection | IEC IP40 |
| Degree of protection against electric shock | Class I |
| Proof tracking index (PTI) | 250 (High Temperature type with suffix "-T": 175) |
| Ambient operating temperature | D3V-21: -25°C to 85°C with no icing D3V-16: -25°C to 105°C (High Temperature type "H": -25°C to 125°C) with no icing D3V-11: -25°C to 105°C (High Temperature types "H": -25°C to 125°C, "T": -25°C to 155°C) with no icing D3V-6: -25°C to 105°C (High Temperature types "H": -25°C to 125°C, "T": -25°C to 200°C) with no icing D3V-01: -25°C to 85°C (High Temperature type "T": -25°C to 200°C) with no icing |
| Ambient operating humidity | 85% max. (for 5°C to 35°C) |
| Weight | Approx. 6.2 g (plunger models) |

Note: 1. Data shown are of initial value.

2. The dielectric strength values shown in the table are for models with a Separator.

3. For plunger models, the above values apply for use at both the free position and total travel position. For lever models, they apply at the total travel position.

4. For testing conditions, contact your OMRON sales representative.

■ Contact Specifications

| Item | | D3V-21 | D3V-16 | D3V-11 | D3V-6 | D3V-01 |
|-------------------------|----------------------|-----------------|--|-----------|-----------|---------------|
| Contact | Specification | Rivet | | | | Crossbar |
| | Material | Silver alloy | | | | Gold alloy |
| | Gap (standard value) | 0.5 mm | 1 mm (F gap type) or 0.5 mm (G gap type) | | | 1.0 mm |
| Inrush current | NC | 50 A max. | 40 A max. | 24 A max. | 15 A max. | --- |
| | NO | | | | | |
| Minimum applicable load | | 160 mA at 5 VDC | | | | 1 mA at 5 VDC |

Note: Minimum applicable loads are indicated by N standard reference values. This value represents the failure rate at a 60% (λ_{60}) reliability level (JIS C5003). The equation $\lambda_{60}=0.5 \times 10^{-6}$ / operations indicates that a failure rate of 1/2,000,000 operations can be expected at a reliability level of 60%

■ Contact Form

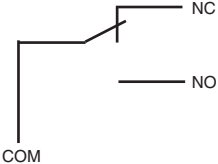
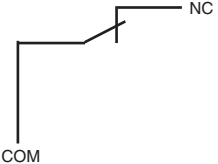
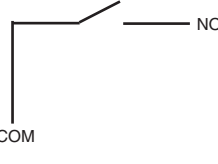
| SPDT | SPST-NC | SPST-NO |
|---|---|---|
|  |  |  |

Dimensions

■ Terminals

Note: Unless otherwise specified, all units are in millimeters and a tolerance of ± 0.4 mm applies to all dimensions

| Terminal type | Solder Terminal (A) | Quick-connect Terminal (#187) (C2) | Quick-connect Terminal (#250) (C) | Quick-connect RAST5 Terminals (#250)(C6) |
|---------------------|---|---|--|---|
| COM |  |  |  |  |
| Terminal dimensions |  |  |  |  |

Note: The table above is for the SPDT contact specifications. Two terminals will be available for SPST-NO or SPST-NC contact specifications. For terminal positions, refer to the above *Contact Form*.

■ Mounting Holes

All switches may be panel mounted using M3 mounting screws with plane washers or spring washers to securely mount the switch. Tighten the screws to a torque of 0.39 to 0.59 N·m.



■ Dimensions and Operating Characteristics

- Note:**
- Unless otherwise specified, all units are in millimeters and a tolerance of ± 0.4 mm applies to all dimensions
 - The following illustrations and drawings are for quick-connect terminals (#187) (terminals C2). D3V models also incorporate terminals A, C, and C6, which are omitted from the following drawings. Refer to *Terminals* section for the dimensions of these terminals.
 - The □ in the model number is for the terminal code.
 - The Δ in the model number is for combinations of the enclosure material, the mounting hole size and the special code as indicated in the *Model Number Legend* and *Available Combinations* tables. The hole size in the following illustrations of models with a suffix "K" in the Δ is 2.9 mm.
 - The operating characteristics are for operation in the A direction (↓).

Plunger Models

- D3V-21G-1□4A-Δ
- D3V-16-1□5-Δ
- D3V-11-1□5-Δ
- D3V-11-1□4-Δ
- D3V-6-1□4-Δ
- D3V-6G-1□3-Δ
- D3V-01-1□2-Δ
- D3V-01-1□3-Δ



| Model | D3V-21G-1□4A-Δ | D3V-16-1□5-Δ D3V-11-1□5-Δ | D3V-11-1□4-Δ D3V-6-1□4-Δ | D3V-6G-1□3-Δ | D3V-01-1□3-Δ | D3V-01-1□2-Δ |
|---------|----------------|--|-----------------------------|--------------|--------------|--------------|
| OF max. | 125 gf | 200 gf | 100 gf | 50 gf | 50 gf | 25 gf |
| RF min. | 20 gf | 50 gf | 15 gf | 5 gf | 5 gf | 3 gf |
| PT max. | 1.2 mm | 1.2 mm | | | 1.2 mm | |
| OT min. | 1.0 mm | 1.0 mm | | | 1.0 mm | |
| MD max. | 0.3 mm | 0.4 mm (F gap type) or 0.3 mm (G gap type) | | | 0.4 mm | |
| OP | 14.7±0.4 mm | | | | | |

Short Hinge Lever Models

- D3V-21G1-1□4A-Δ
- D3V-161-1□5-Δ
- D3V-111-1□5-Δ
- D3V-111-1□4-Δ
- D3V-61-1□4-Δ
- D3V-6G1-1□3-Δ
- D3V-011-1□3-Δ

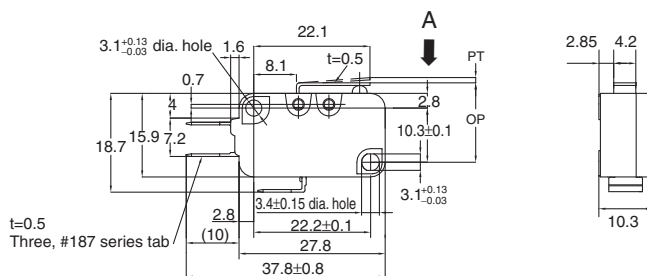

- D3V-21G1M-1□4A-Δ
- D3V-161M-1□5-Δ
- D3V-111M-1□5-Δ
- D3V-111M-1□4-Δ
- D3V-61M-1□4-Δ
- D3V-6G1M-1□3-Δ
- D3V-011M-1□3-Δ



| Model | D3V-21G1(M)-1□4A-Δ | D3V-161(M)-1□5-Δ D3V-111(M)-1□5-Δ | D3V-111(M)-1□4-Δ D3V-61(M)-1□4-Δ | D3V-6G1(M)-1□3-Δ | D3V-011(M)-1□3-Δ |
|---------|--------------------|--|-------------------------------------|------------------|------------------|
| OF max. | 125 gf | 200 gf | 100 gf | 50 gf | |
| RF min. | 20 gf | 50 gf | 15 gf | 5 gf | |
| PT max. | 1.6 mm | 1.6 mm | | | 1.6 mm |
| OT min. | 0.8 mm | 0.8 mm | | | 0.8 mm |
| MD max. | 0.5 mm | 0.6 mm (F gap type) or 0.5 mm (G gap type) | | | 0.6 mm |
| OP | 15.2 ± 0.5 mm | | | | |

- D3V-21G1K-1□4A-Δ
- D3V-161K-1□5-Δ
- D3V-111K-1□5-Δ
- D3V-111K-1□4-Δ
- D3V-61K-1□4-Δ
- D3V-6G1K-1□3-Δ
- D3V-011K-1□3-Δ



| Model | D3V-21G1K-1□4A-Δ | D3V-161K-1□5-Δ D3V-111K-1□5-Δ | D3V-111K-1□4-Δ D3V-61K-1□4-Δ | D3V-6G1K-1□3-Δ | D3V-011K-1□3-Δ |
|---------|------------------|--|---------------------------------|----------------|----------------|
| OF max. | 85 gf | 130 gf | 65 gf | 35 gf | |
| RF min. | 8 gf | 16 gf | 8 gf | 4 gf | |
| PT max. | 3.5 mm | 3.5 mm | | | 3.5 mm |
| OT min. | 1.1 mm | 1.1 mm | | | 1.1 mm |
| MD max. | 1.1 mm | 1.2 mm (F gap type) or 1.1 mm (G gap type) | | | 1.2 mm |
| OP | 15.2 ± 1.2 mm | | | | |

Hinge Lever Models

- D3V-21G2-1□4A-Δ
- D3V-162-1□5-Δ
- D3V-112-1□5-Δ
- D3V-112-1□4-Δ
- D3V-62-1□4-Δ
- D3V-6G2-1□3-Δ
- D3V-012-1□3-Δ

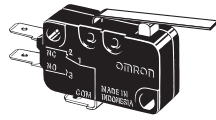

- D3V-21G2M-1□4A-Δ
- D3V-162M-1□5-Δ
- D3V-112M-1□5-Δ
- D3V-112M-1□4-Δ
- D3V-62M-1□4-Δ
- D3V-6G2M-1□3-Δ
- D3V-012M-1□3-Δ

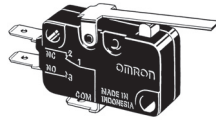

Note: Stainless-steel lever

| Model | D3V-21G2(M)-1□4A-Δ | D3V-162(M)-1□5-Δ D3V-112(M)-1□5-Δ | D3V-112(M)-1□4-Δ D3V-62(M)-1□4-Δ | D3V-6G2(M)-1□3-Δ | D3V-012(M)-1□3-Δ |
|---------|--------------------|--|-------------------------------------|------------------|------------------|
| OF max. | 80 gf | 125 gf | 60 gf | | 30 gf |
| RF min. | 6 gf | 14 gf | 6 gf | | --- |
| PT max. | 4.0 mm | 4.0 mm | | 4.0 mm | |
| OT min. | 1.6 mm | 1.6 mm | | 1.6 mm | |
| MD max. | 0.8 mm | 1.5 mm (F gap type) or 0.8 mm (G gap type) | | | 1.5 mm |
| OP | 15.2 ± 1.2 mm | | | | |

- D3V-21G2K-1□4A-Δ
- D3V-162K-1□5-Δ
- D3V-112K-1□5-Δ
- D3V-112K-1□4-Δ
- D3V-62K-1□4-Δ
- D3V-6G2K-1□3-Δ
- D3V-012K-1□3-Δ

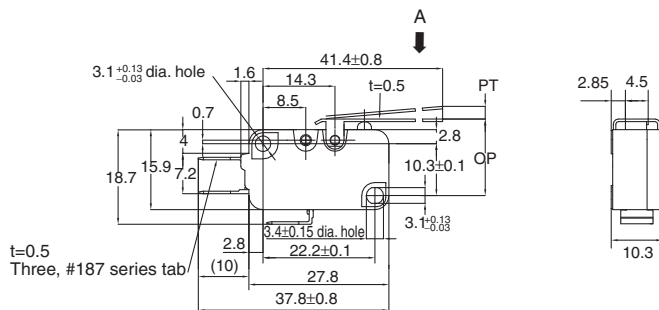
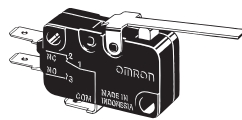

| Model | D3V-21G2K-1□4A-Δ | D3V-162K-1□5-Δ D3V-112K-1□5-Δ | D3V-112K-1□4-Δ D3V-62K-1□4-Δ | D3V-6G2K-1□3-Δ | D3V-012K-1□3-Δ |
|---------|------------------|--|---------------------------------|----------------|----------------|
| OF max. | 45 gf | 70 gf | 35 gf | 20 gf | |
| RF min. | 4 gf | 8 gf | 4 gf | --- | |
| PT max. | 6.0 mm | 6.0 mm | | 6.0 mm | |
| OT min. | 2.5 mm | 2.5 mm | | 2.5 mm | |
| MD max. | 1.3 mm | 2.0 mm (F gap type) or 1.3 mm (G gap type) | | | 2.0 mm |
| OP | 15.2 ± 2.0 mm | | | | |

Long Hinge Lever Models

- D3V-21G3-1□4A-Δ
- D3V-163-1□5-Δ
- D3V-113-1□5-Δ
- D3V-113-1□4-Δ
- D3V-63-1□4-Δ
- D3V-6G3-1□3-Δ
- D3V-013-1□3-Δ



- D3V-21G3M-1□4A-Δ
- D3V-163M-1□5-Δ
- D3V-113M-1□5-Δ
- D3V-113M-1□4-Δ
- D3V-63M-1□4-Δ
- D3V-6G3M-1□3-Δ
- D3V-013M-1□3-Δ



| Model | D3V-21G3(M)-1□4A-D | D3V-163(M)-1□5-D D3V-113(M)-1□5-D | D3V-113(M)-1□4-D D3V-63(M)-1□4-D | D3V-6G3(M)-1□3-D | D3V-013(M)-1□3-D |
|---------|---|--|-------------------------------------|--|------------------|
| OF max. | 45 gf | 70 gf | 35 gf | 20 gf | |
| RF min. | 3 gf | 6 gf | --- | --- | |
| PT max. | 9.0 mm | 9.0 mm | 9.0 mm | | 9.0 mm |
| OT min. | 2.0 mm | 2.0 mm | 3.2 mm | | 3.2 mm |
| MD max. | 2.0 mm | 2.8 mm (F gap type) or 2.0 mm (G gap type) | | 2.8 mm (F gap type) or 2.0 mm (G gap type) | |
| OP | 15.2 ^{+2.6} / _{-3.2} mm | | 15.2 ± 2.6 mm | | |

- D3V-21G3K-1□4A-Δ
- D3V-163K-1□5-Δ
- D3V-113K-1□5-Δ
- D3V-113K-1□4-Δ
- D3V-63K-1□4-Δ
- D3V-6G3K-1□3-Δ
- D3V-013K-1□3-Δ



| Model | D3V-21G3K-1□4A-D | D3V-163K-1□5-D D3V-113K-1□5-D | D3V-113K-1□4-D D3V-63K-1□4-D | D3V-6G3K-1□3-D | D3V-013K-1□3-D |
|---------|------------------|--|---------------------------------|----------------|----------------|
| OF max. | 20 gf | 35 gf | 20 gf | 10 gf | |
| RF min. | --- | 4 gf | --- | --- | |
| PT max. | 15.0 mm | 15.0 mm | | | 15.0 mm |
| OT min. | 4.0 mm | 4.0 mm | | | 4.0 mm |
| MD max. | 3.0 mm | 3.8 mm (F gap type) or 3.0 mm (G gap type) | | | 3.8 mm |
| OP | 15.2 ± 3.0 mm | | | | |

Simulated Roller Lever Models

- D3V-21G4-1□4A-Δ
- D3V-164-1□5-Δ
- D3V-114-1□5-Δ
- D3V-114-1□4-Δ
- D3V-64-1□4-Δ
- D3V-6G4-1□3-Δ
- D3V-014-1□3-Δ

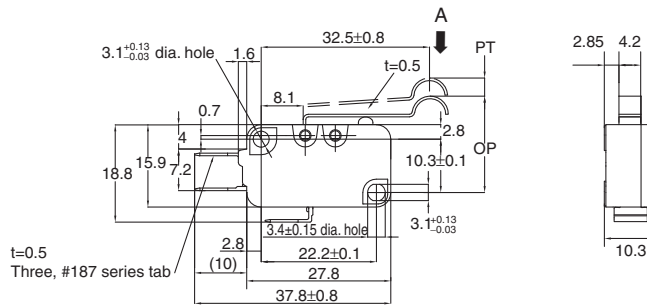

- D3V-21G4M-1□4A-Δ
- D3V-164M-1□5-Δ
- D3V-114M-1□5-Δ
- D3V-114M-1□4-Δ
- D3V-64M-1□4-Δ
- D3V-6G4M-1□3-Δ
- D3V-014M-1□3-Δ

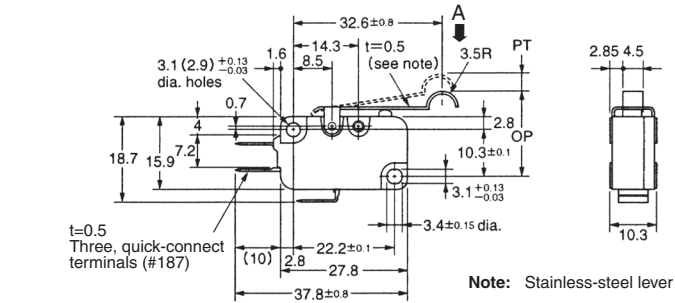

| Model | D3V-21G4(M)-1□4A-Δ | D3V-164(M)-1□5-Δ D3V-114(M)-1□5-Δ | D3V-114(M)-1□4-Δ D3V-64(M)-1□4-Δ | D3V-6G4(M)-1□3-Δ | D3V-014(M)-1□3-Δ |
|---------|--------------------|--|-------------------------------------|------------------|------------------|
| OF max. | 85 gf | 125 gf | 60 gf | 30 gf | |
| RF min. | 7 gf | 14 gf | 6 gf | --- | |
| PT max. | 4.0 mm | 4.0 mm | | | 4.0 mm |
| OT min. | 1.6 mm | 1.6 mm | | | 1.6 mm |
| MD max. | 1.4 mm | 1.5 mm (F gap type) or 0.8 mm (G gap type) | | | 1.5 mm |
| OP | 18.7 ± 1.2 mm | | | | |

- D3V-21G4K-1□4A-Δ
- D3V-164K-1□5-Δ
- D3V-114K-1□5-Δ
- D3V-114K-1□4-Δ
- D3V-64K-1□4-Δ
- D3V-6G4K-1□3-Δ
- D3V-014K-1□3-Δ

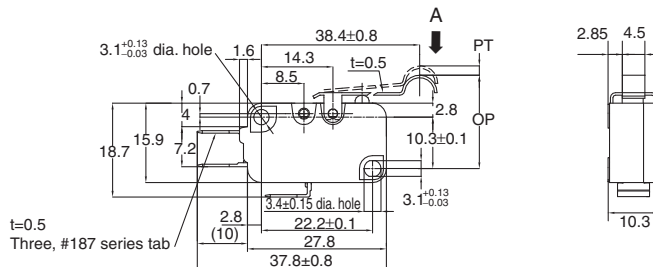

| Model | D3V-21G4K-1□4A-D | D3V-164K-1□5-D D3V-114K-1□5-D | D3V-114K-1□4-D D3V-64K-1□4-D | D3V-6G4K-1□3-D | D3V-014K-1□3-D |
|---------|------------------|--|---------------------------------|----------------|----------------|
| OF max. | 55 gf | 75 gf | 40 gf | 20 gf | |
| RF min. | 3 gf | 10 gf | 3 gf | --- | |
| PT max. | 8.0 mm | 8.0 mm | | | 8.0 mm |
| OT min. | 1.5 mm | 1.5 mm | | | 1.5 mm |
| MD max. | 3.0 mm | 3.5 mm (F gap type) or 3.0 mm (G gap type) | | | 3.5 mm |
| OP | 18.7 ± 1.2 mm | | | | |

Short Hinge Roller Lever Models

- D3V-21G5-1□4A-Δ
- D3V-165-1□5-Δ
- D3V-115-1□5-Δ
- D3V-115-1□4-Δ
- D3V-65-1□4-Δ
- D3V-6G5-1□3-Δ
- D3V-015-1□3-Δ



- D3V-21G5M-1□4A-Δ
- D3V-165M-1□5-Δ
- D3V-115M-1□5-Δ
- D3V-115M-1□4-Δ
- D3V-65M-1□4-Δ
- D3V-6G5M-1□3-Δ
- D3V-015M-1□3-Δ



| Model | D3V-21G5(M)-1□4A-Δ | D3V-165(M)-1□5-Δ D3V-115(M)-1□5-Δ | D3V-115(M)-1□4-Δ D3V-65(M)-1□4-Δ | D3V-6G5(M)-1□3-Δ | D3V-015(M)-1□3-Δ |
|-------------------------------|----------------------------|--|-------------------------------------|------------------|----------------------------|
| OF max. RF min. | 145 gf 20 gf | 240 gf 50 gf | 120 gf 15 gf | | 60 gf 6 gf |
| PT max. OT min. MD max. | 1.6 mm 0.8 mm 0.5 mm | 1.6 mm 0.8 mm 0.6 mm (F gap type) or 0.5 mm (G gap type) | | | 1.6 mm 0.8 mm 0.6 mm |
| OP | 20.7±0.6 mm | | | | |

- D3V-21G5K-1□4A-Δ
- D3V-165K-1□5-Δ
- D3V-115K-1□5-Δ
- D3V-115K-1□4-Δ
- D3V-65K-1□4-Δ
- D3V-6G5K-1□3-Δ
- D3V-015K-1□3-Δ



| Model | D3V-21G5K-1□4A-D | D3V-165K-1□5-D D3V-115K-1□5-D | D3V-115K-1□4-D D3V-65K-1□4-D | D3V-6G5K-1□3-D | D3V-015K-1□3-D |
|-------------------------------|----------------------------|--|---------------------------------|----------------|----------------------------|
| OF max. RF min. | 100 gf 8 gf | 160 gf 15 gf | 80 gf 8 gf | | 40 gf 4 gf |
| PT max. OT min. MD max. | 2.6 mm 1.0 mm 8.0 mm | 2.6 mm 1.0 mm 0.9 mm (F gap type) or 0.8 mm (G gap type) | | | 2.6 mm 1.0 mm 0.9 mm |
| OP | 20.7 ± 1.0 mm | | | | |

Hinge Roller Lever Models

- D3V-21G6-1□4A-Δ
- D3V-166-1□5-Δ
- D3V-116-1□5-Δ
- D3V-116-1□4-Δ
- D3V-66-1□4-Δ
- D3V-6G6-1□3-Δ
- D3V-016-1□3-Δ



- D3V-21G6M-1□4A-Δ
- D3V-166M-1□5-Δ
- D3V-116M-1□5-Δ
- D3V-116M-1□4-Δ
- D3V-66M-1□4-Δ
- D3V-6G6M-1□3-Δ
- D3V-016M-1□3-Δ



| Model | D3V-21G6(M)-1□4A-Δ | D3V-166(M)-1□5-Δ D3V-116(M)-1□5-Δ | D3V-116(M)-1□4-Δ D3V-66(M)-1□4-Δ | D3V-6G6(M)-1□3-Δ | D3V-016(M)-1□3-Δ |
|-------------------------------|----------------------------|--|-------------------------------------|------------------|----------------------------|
| OF max. RF min. | 80 gf 5 gf | 125 gf 14 gf | 60 gf 6 gf | 30 gf --- | |
| PT max. OT min. MD max. | 4.0 mm 1.6 mm 0.8 mm | 4.0 mm 1.6 mm 1.5 mm (F gap type) or 0.8 mm (G gap type) | | | 4.0 mm 1.6 mm 1.5 mm |
| OP | 20.7±1.2 mm | | | | |

- D3V-21G6K-1□4A-Δ
- D3V-166K-1□5-Δ
- D3V-116K-1□5-Δ
- D3V-116K-1□4-Δ
- D3V-66K-1□4-Δ
- D3V-6G6K-1□3-Δ
- D3V-016K-1□3-Δ



| Model | D3V-21G6K-1□4A-D | D3V-166K-1□5-D D3V-116K-1□5-D | D3V-116K-1□4-D D3V-66K-1□4-D | D3V-6G6K-1□3-D | D3V-016K-1□3-D |
|-------------------------------|----------------------------|--|---------------------------------|----------------|----------------------------|
| OF max. RF min. | 50 gf 3 gf | 75 gf 10 gf | 40 gf 3 gf | 20 gf --- | |
| PT max. OT min. MD max. | 7.2 mm 2.0 mm 2.0 mm | 7.2 mm 2.0 mm 2.7 mm (F gap type) or 2.0 mm (G gap type) | | | 7.2 mm 2.0 mm 2.7 mm |
| OP | 20.7 ± 2.2 mm | | | | |

Precautions

Be sure to read the precautions and information common to all Snap Action and Detection Switches, contained in the Technical User's Guide, "Snap Action Switches, Technical Information" for correct use.

■ Correct Use

Mounting Direction

Mount lever-operated switches with a maximum operating force of 0.49 N in a direction where the actuator weight will not be applied to the switch. Since the switch is designed for a small load, its resetting force is small. Therefore, resetting failure may occur if unnecessary load is applied to the switch.

Insulation Distance

According to EN61058-1, the minimum insulation thickness for this switch should be 1.1 mm and minimum clearance distance between the terminal and mounting plate should be 1.9 mm. If the insulation distance cannot be provided in the product incorporating the switch, either use a switch with insulation barrier or use a Separator to ensure sufficient insulation distance.

Using Microloads

Using a model for ordinary loads to switch microloads may result in faulty operation. Instead, use the models that are designed for microloads and that operate in the following range;



However, even when using microload models within the operating range shown above, if inrush current or inductive voltage spikes occur when the contact is opened or closed, then contact wear may increase and so decrease the service life. Therefore, insert a contact protection circuit where necessary.

Solder Terminal Approval Conditions

| |
|--|
| Use of soldering iron for normal soldering is acceptable. Soldering hook holes version available. |
| Soldering terminal types 1 and 2 are met. |

■ Cautions

Handling

Be careful not to drop the switch. Doing so may cause damage to the switch's internal components because it is designed for a small load.

All sales are subject to Omron Electronic Components LLC standard terms and conditions of sale, which can be found at http://www.components.omron.com/components/web/webfiles.nsf/sales_terms.html

ALL DIMENSIONS SHOWN ARE IN MILLIMETERS.
To convert millimeters into inches, multiply by 0.03937. To convert grams into ounces, multiply by 0.03527.

OMRON[®]

**OMRON ELECTRONIC
COMPONENTS LLC**

55 E. Commerce Drive, Suite B
Schaumburg, IL 60173

847-882-2288

OMRON ON-LINE

Global - <http://www.omron.com>

USA - <http://www.components.omron.com>

Cat. No. X303-E-1

11/10

Specifications subject to change without notice

Printed in USA

Miniature Basic Switch **D3V**