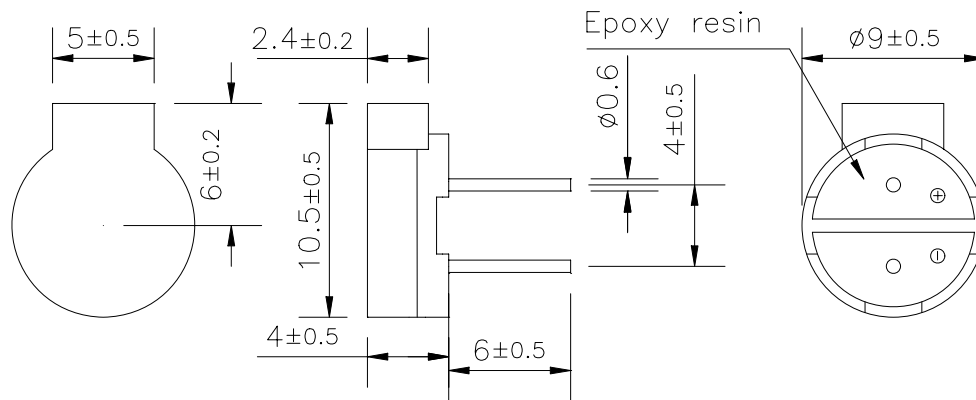
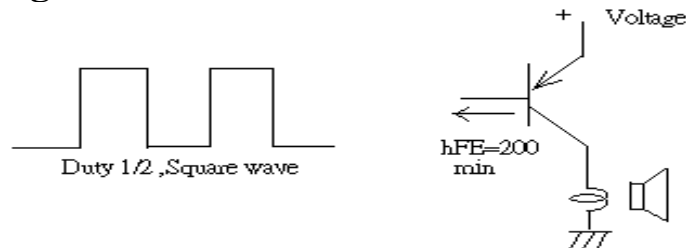

**Sales Outline Drawing**Revision **A****Specifications:**

Oscillation Frequency (Hz)	2731
Operating Voltage (Vp-p)	2.0 ~ 5.0
Rated Voltage (Vp-p)	3.0
Current Consumption Max. (mA)	70 at Rated Voltage
Sound Pressure Level (dB/min)	85 at 10cm at Rated Voltage
Coil Resistance ( $\Omega$ )	$15 \pm 2$
Operating Temperature ( $^{\circ}\text{C}$ )	$-30 \sim +70$
Storage Temperature ( $^{\circ}\text{C}$ )	$-40 \sim +80$
Lead Pin	Tin Plated Brass
Housing	PPO plastic resin (Color: Black)
Weight (Grams)	0.5
Condition by wave soldering ( $^{\circ}\text{C}$ )	$245 \pm 5 / 3 \pm 0.5$ sec
Condition by hand soldering ( $^{\circ}\text{C}$ )	$350 \pm 20 /$ within 5 sec
Options	For other options contact factory

PS: Vp-p = 1/2duty, square wave

**RoHS Compliant****Dimensions:** (units: mm)**Recommended Driving Circuit:**

**The base current  $I_b$  should be high enough so that it saturates the collector current of the transistor with the CB load.**