

Part Number:

255-400ST16-ROX
255-400SR16-ROX

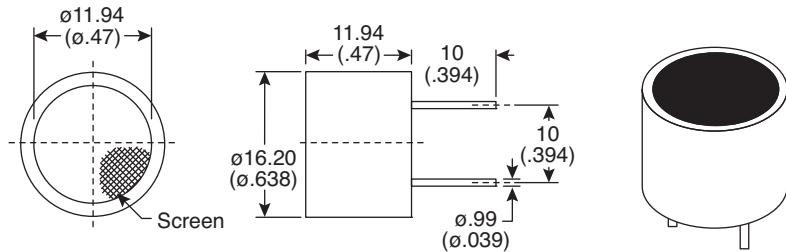

Directivity for 255-400ST16-ROX

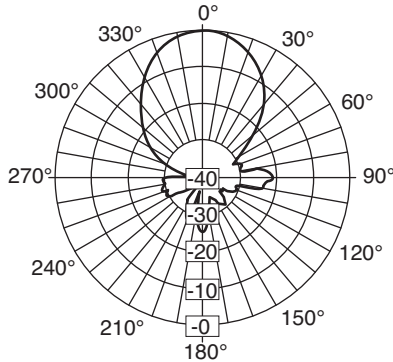

Sensitivity For 255-400SR16-ROX

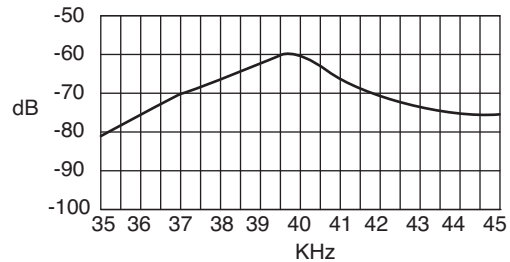

Sound Pressure for 255-400ST16-ROX

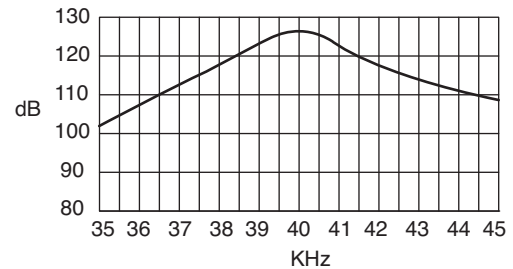

SPL Variation vs. Driving Voltage

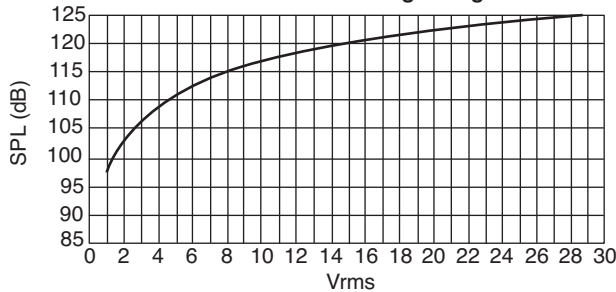

Impedance/Phase Angle vs. Frequency
Tested under 1Vrms Oscillation Level

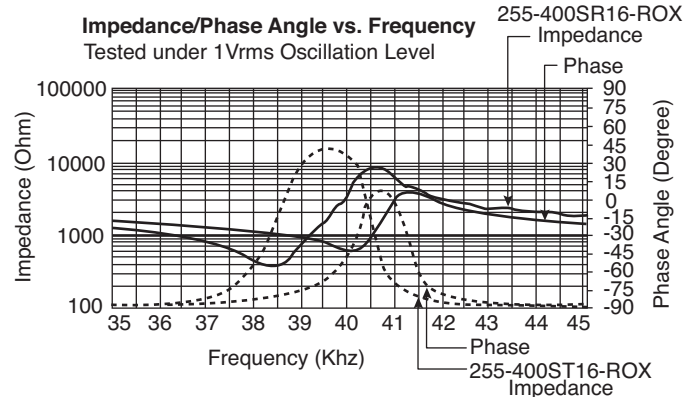

Sensitivity/Sound Pressure Level
Tested under 10Vrms @30cm

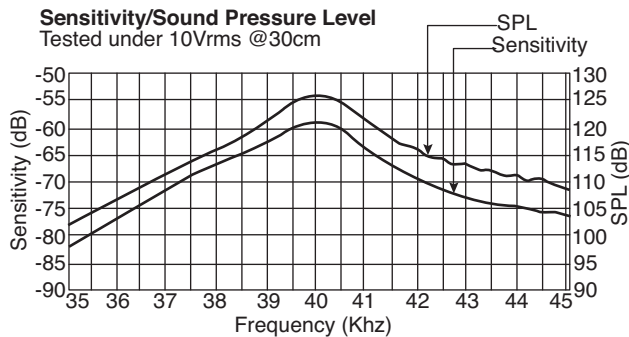

Electrical Specifications:

- Center Frequency (f_0): 40.0KHz \pm 1.0KHz
- SPL @ f_0 for 255-400ST16-ROX: 119dB (0dB re 0.0002 μ bar)
- Sensitivity @ f_0 for 255-400SR16-ROX: -65dB (0dB=1V/ μ bar)
- Bandwidth (-6dB): 255-400ST16-ROX - 2KHz; 255-400SR16-ROX - 2.5KHz
- Allowable Input Power: 0.2W
- Capacitance: 2,400pF \pm 20% @ 1KHz

Mechanical Specifications:

- Type: Transmitter - 255-400ST16-ROX;
Receiver - 255-400SR16-ROX
- Operating Temperature: -30°C ~ +85°C
- Storage Temperature: -40°C ~ +100°C

Note:

- RoHS Compliant by Exemption