

# Motor Contactor J7KN

## Main contactor

- AC & DC operated
- Integrated auxiliary contacts
- Screw fixing and snap fitting (35 mm DIN rail) up to 37 kW
- Range from 4 to 110 kW (AC 3, 380/415V)
- Finger proof (BGV A2)
- System contactors for Fuseless Load Feeders with integrated link module

## Accessories

- front mounted single pole additional auxiliary contacts (1 NO or 1 NC)
- Side mounted additional auxiliary contacts (1 NO/1 NC)
- Mechanical interlock
- Suppressors (RC and varistor)
- Pneumatic timer modules
- Link modules MPCB - Motor contactor



## Approved Standards

Standard	Guide No (US,C)
UL	NLDX, NLDX7
IEC 947-4-1	see page 95
VDE 0660	
EN 60947-4-1	

# Ordering Information

## ■ Model Number Legend

### 1. Motor Contactors

J7KN-□-□□-□□-□□□□  
 1 2 3 4 5

- 1) Motor Contactor
- 2) G: DC solenoid motor contactor
- 3) Rated Motor Current (AC3 400V)
  - 10: 10A
  - 14: 14A
  - 18: 18A
  - 22: 22A
  - 24: 24A
  - 32: 32A
  - 40: 40A
  - 50: 50A
  - 62: 62A
  - 74: 74A
  - 85: 85A
  - 110: 110A
  - 151: 150A
  - 176: 175A
  - 200: 200A
- 4) Integrated auxiliary contact
  - 10: 1NO 0NC
  - 01: 0NO 1NC
  - 21: 2NO 1NC
  - 22: 2NO 2NC
  - : 0NO 0NC
  - 4: 4 main poles
- 5) Coil voltage (AC operated)
  - 24: AC24V 50/60Hz
  - 48: AC48V 50Hz
  - 90: AC100V 50/60 Hz
  - 110: AC110V 50Hz, AC110-120V 60Hz
  - 180: AC180-210V 50Hz, AC200-240V 60Hz
  - 230: AC220-240V 50Hz, AC240V 60Hz
  - 400: AC380-415V 50Hz, AC415-440V 60Hz
  - 500: AC500-550V 50Hz, AC550-600V 60Hz

Coil voltage(DC operated)

  - 24D: DC24V
  - 48D: DC48V
  - 110D: DC110V
  - 125D: DC125V

Coil voltage(DC solenoid operated - G-type)

  - 24D: DC24V
  - 48D: DC48V
  - 60D: DC60V
  - 110D: DC110V
  - 125D: DC125V
  - 220D: DC220V

Coil voltage(AC & DC operated) for J7KN 151 & J7KN 176 only

  - 24: 24V 50/60Hz, 24VDC
  - 48: 48V 50/60Hz, 48VDC
  - 110: 110-120V 50/60Hz, 110VDC
  - 230: 220-240V 50/60Hz, 220VDC
  - 400: 380-415V 50/60Hz

### 2. Sytem Contactors for Fuseless Load Feeders with integrated Link Module

J7KN-□□□-□□-□□□-VK3  
 1 2 3 4 5

- 1) Additional reference for LVSG
- 2) Rated Motor Current (AC 3 400 V)
  - 10: 10 A
  - 14: 14 A
  - 18: 18 A
  - 22: 22 A
- 3) Integrated Auxiliary Contact
  - 10: 1NO 0NC
  - 01: 0NO 1NC
- 4) Coil voltage (AC operated)
  - 24: AC24V 50/60Hz
  - 48: AC48V 50Hz
  - 110: AC110V 50Hz, AC110-120V 60Hz
  - 180: AC180-210V 50Hz, AC200-240V 60Hz
  - 230: AC220-240V 50Hz, AC240V 60Hz
  - 400: AC380-415V 50Hz, AC415-440V 60Hz
  - 500: AC500-550V 50Hz, AC550-600V 60Hz
- 5) Attached link module VK 3

### 3. Aux. Contact Modules for Motor Contactors

J73KN-□-□□-□  
 1 2 3 4

- 1) Auxiliary Contact Modules
- 2) B: for motor contactor (4-37kW)  
 C: for motor contactor (11-37kW)  
 D: for motor contactor (75-90kW)  
 E: for motor contactor (110kW)
- 3) Combination of NO/NC contacts
  - 10: 1NO 0NC
  - 01: 0NO 1NC
  - 11: 1NO 1NC
  - 22: 2NO 2NC
- 4) S: side mounting for motor contactor (11-37kW and 75-90 kW)  
 : front mounting for motor contactor (4-37kW)  
 A: 6A version  
 F: front mounting for motor contactor (75-90kW)  
 U: EM and LB version

### 4. Accessories for Motor Contactors (Pneumatic Timers)

J74KN-□-□□ □□□ □  
 1 2 3 4 5

- 1) Accessories for Motor Contactors
- 2) B: Motor Contactor (4-18.5kW)
- 3) TP: Pneumatic Timer
- 4) 40: 40 sec  
 180: 180 sec
- 5) DA: ON-delayed  
 IA: OFF-delayed

### 5. Accessories for Motor Contactors (Mechanical Interlock)

J74KN-□-□□  
 1 2 3

- 1) Accessories for Motor Contactors
- 2) B: Motor Contactor (4-18.5kW)  
 C: Motor Contactor (11-37kW)  
 D: Motor Contactor (45-55kW)  
 E: Motor Contactor (75-90kW)
- 3) ML: Mechanical Interlock

**6. Accessories for Motor Contactors (RC Suppressor units)**

J74KN-□-□□ □□□  
 1 2 3 4

- 1) Accessories for Motor Contactors
- 2) A: for Mini Motor Contactor and Motor Contactor (4-18.5kW)  
 (between DIN-rail and Contactor)  
 B: for Mini Motor Contactor and Motor Contactor (4-55kW)  
 C: for Motor Contactor (4-37kW) to snap on the contactor  
 D: for Mini Motor Contactor (4-5.5kW)
- 3) RC: RC-surge suppressors
- 4) 48: 24 - 48 VAC/DC (A+B type)  
 230: 110 - 230 VAC/DC (A+B type)  
 400: 250 - 415 VAC/DC (A+B type)  
 24: 12 - 48 VAC/DC (C+D type)  
 110: 48 - 127 VAC/DC (C+D type)  
 230: 110 - 250 VAC/DC (C+D type)

**7. Accessories for Motor Contactors (4-37 kW) (Varistor units)**

J74KN-□-□□ □□□  
 1 2 3 4

- 1) Accessories for Motor Contactors
- 2) A: for Motor Contactor (4-11kW) to snap on to coil terminals  
 B: for Motor Contactor (4-37kW) to snap on to contactor
- 3) VG: Varistor Suppressors
- 4) 230: 110-230VAC/DC  
 400: 250-415VAC/DC

**8. Accessories for Motor Contactors (Additional Terminals and Terminal Covers)**

J7KN-□□□□□□□  
 1 2

- 1) Accessories for Motor Contactors
- 2) LG-9030: for Motor Contactors (22-37 kW)  
 Additional Terminal for Single Pole  
 LG-11224: for Motor Contactors (75-90 kW)  
 Additional Terminal for Single Pole  
 LG-10404: for Motor Contactors (75-90 kW)  
 Terminal Cover for 3 terminals  
 Marking Systems for contactors J7KNA - J7KN 74 and aux.  
 contact blocks J73KN-B  
 P487-1: Marking plate, 2-section without marking, divisible  
 P245-1: Marking plate, 4-section without marking, divisible

**9. Insulated wiring systems for motor contactors**

Parallel or reverse contactors  
 Star-Delta contactors

J75-WK-□□  
 1 2 3







- 1) Additional reference for LVSG
- 2) Wiring system
- 3) Combination of 2 contactors, type:  
 21 = J7KN 10 - ..22  
 41 = J7KN 24 - ..40  
  
 Star - delta combination of 3 contactors, type:  
 22 = J7KN 10 - ..22

## List of Models



### Contactors 3-pole

- Up to 210A AC3
- Up to 350A AC1
- DIN-rail mounting up to AC3 74A
- International Approvals
- Data according to IEC 947 / EN 60947









Ratings													
AC3	400V Motor	10A	14A	18A	22A	24A	32A	40A	50A	62A	74A		
	380-400V	4kW	5,5kW	7,5kW	11kW	11kW	15kW	18,5kW	22kW	30kW	37kW		
	660-690V	5,5kW	7,5kW	10kW	10kW	15kW	18,5kW	18,5kW	30kW	37kW	45kW		
AC1	690V at 40°C	25A	25A	32A	32A	50A	65A	80A	110A	120A	130A		
Type		J7KN-10-10	J7KN-14-10	J7KN-18-10	J7KN-22-10	J7KN-24	J7KN-32	J7KN-40	J7KN-50	J7KN-62	J7KN-74		
Auxiliary contacts		1NO	1NO	1NO	1NO	-	-	-	-	-	-		
Type		J7KN-10-01	J7KN-14-01	J7KN-18-01	J7KN-22-01	-	-	-	-	-	-		
Auxiliary contacts		1NC	1NC	1NC	1NC	-	-	-	-	-	-		
<b>Cable cross-section</b>													
Solid	mm <sup>2</sup>	0,75 - 6				1,5 - 25		4 - 50					
Flexible	mm <sup>2</sup>	1 - 4				2,5 - 16		10 - 35					
Cables per clamp		2				1 + 1		1 + 1					
<b>Auxiliary contact</b>													
I <sub>th</sub>	40°C	A 16					-		-				
AC15	230V	A 12					-		-				
	400V	A 4					-		-				
<b>Power consumption of coils</b>													
	Inrush VA	33 - 45				90 - 115		140 - 165					
	Hold VA	7 - 10				9 - 13		13 - 18					
	Operation range of coils	0,85 - 1,1				0,85 - 1,1		0,85 - 1,1					
Mounting		35mm DIN-rail or base											
<b>Additional aux. contact blocks</b>													
Front mounting contact configuration		 1NO				 1NC							
		maximal 4 J73KN-B..											
<b>Additional aux. contact blocks</b>													
Side mounting contact configuration		-				 1NO+1NC							
<b>Overload Relay (thermal)</b>													
Single phase protection Temperature compensation Trip and alarm contacts													
Type		J7TKN-B				J7TKN-C				J7TKN-D			
	Setting Ranges					Setting Ranges				Setting Ranges			
		0,12 - 0,18A		4 - 6A		28 - 42A				40 - 52A			
		0,18 - 0,27A		6 - 9A						52 - 65A			
		0,27 - 0,4A		8 - 11A						60 - 74A			
		0,4 - 0,6A		10 - 14A									
		0,6 - 0,9A		13 - 18A									
		0,8 - 1,2A		17 - 24A									
		1,2 - 1,8A		23 - 32A									
		1,8 - 2,7A											
		2,7 - 4A											



<b>Ratings</b>						
<b>AC3</b>	<b>400V Motor</b>	<b>85A</b>	<b>110A</b>	<b>150A</b>	<b>175A</b>	<b>210A</b>
	<b>380-400V</b>	<b>45kW</b>	<b>55kW</b>	<b>75kW</b>	<b>90kW</b>	<b>110kW</b>
	660-690V	55kW	55kW	75kW	110kW	132kW
<b>AC1</b>	690V at 40°C	150A	170A	230A	250A	350A
<b>Type</b>		<b>J7KN-85-22</b>	<b>J7KN-110-22</b>	<b>J7KN-151</b>	<b>J7KN-176</b>	<b>J7KN-200-21</b>
Auxiliary contacts		2NO+2NC	2NO+2NC	-	-	2NO+1NC
Type		-	-	-	-	-
Auxiliary contacts		-	-	-	-	-
<b>Cable cross-section</b>						
Solid	mm <sup>2</sup>	10 - 70	10 - 70	busbar	busbar	busbar
Flexible	mm <sup>2</sup>	16 - 50	16 - 50	18x4	18x4	22x4
Cables per clamp		1	1	1	1	1
<b>Auxiliary contact</b>						
I <sub>th</sub>	40°C	A 16		10		
AC15	230V	A 12		3		
	400V	A 6		2		
<b>Power consumption of coils</b>						
	Inrush VA	350 - 420		350	350	700
	hold VA	23 - 29		5	5	20
	Operation range of coils	0,85 - 1,1		0,85 - 1,1		
Mounting		base				
<b>Additional aux. contact blocks</b>						
Front mounting contact configuration		-		2NO + 2NC		
<b>Additional aux. contact blocks</b>						
Side mounting contact configuration		-		1NO + 1NC		-
<b>Overload Relay (thermal)</b>						
Single phase protection Temperature compensation Trip and alarm contacts						
	Type	J7TKN-E		J7TKN-F		
	Setting Ranges	60 - 90A		100 - 150A		
		80 - 120A		140 - 220A		
<b>Busbar Sets</b>						
				J74TK-SU-176	J74TK-SU-200	

Contactors 3-pole

	Ratings				Rated Current AC1 690V A	AC Operated			Type	Pack	Weight
	AC2, AC3			AC1		Aux. Contacts		Coil Voltage <sup>*1</sup> 24V 50/60Hz 110V 50Hz 220-240V 50Hz			
	380V 400V 415V kW	500V kW	660V 690V kW			Built-in					
						NO	NC				
							see page 33				
	4 4 5.5 5.5 7.5 7.5 11 11	5.5 5.5 7.5 7.5 10 10 10 10	5.5 5.5 7.5 7.5 10 10 10 10	25 25 25 25 32 32 32 32	1 - 1 - 1 - 1 -	- 1 - 1 - 1 - 1	max. 4 J73KN-B	J7KN-10-10□□□ J7KN-10-01□□□ J7KN-14-10□□□ J7KN-14-01□□□ J7KN-18-10□□□ J7KN-18-01□□□ J7KN-22-10□□□ J7KN-22-01□□□	1 1 1 1 1 1 1 1	0.23 0.23 0.23 0.23 0.23 0.23 0.23 0.23	
	4 4 5.5 5.5 7.5 7.5 11 11	5.5 5.5 7.5 7.5 10 10 10 10	5.5 5.5 7.5 7.5 10 10 10 10	25 25 25 25 32 32 32 32	- - - - - - - -	- - - - - - - -	-	-	-	-	
	11 15 18.5	15 18.5 18.5	15 18.5 18.5	50 65 80	- - -	- - -	max. 4 J73KN-B + 2 J73KN- C-11S	J7KN-24□□□ J7KN-32□□□ J7KN-40□□□	1 1 1	0.48 0.48 0.48	
	22 30 37	30 37 45	30 37 45	110 120 130	- - -	- - -	max. 4 J73KN-B + 2 J73KN- C11S	J7KN-50□□□ J7KN-62□□□ J7KN-74□□□	1 1 1	0.85 0.85 0.85	
	Ratings				Rated Current AC1 690V A	AC Operated			Type	Pack	Weight
AC2, AC3			AC1	Aux. Contacts		Coil Voltage <sup>*1</sup> 220-230V 50Hz 380-400V 50Hz					
380V 415V kW	500V kW	660V 690V kW		Built-in							
				NO			NC				
	45 55	55 75	55 55	150 170	2 2	2 2		J7KN-85-22□□□ J7KN-110-22□□□	1 1	1.8 1.9	
	75 90	75 90	75 90	230 250	- -	- -	max. 3 1 x J73KN- D22F or 1 x J73KN- D11F and 2 x J73KN- D11S	J7KN-151□□□ <sup>*2</sup> J7KN-176□□□ <sup>*2</sup>	1 1	4 4	
	110	132	132	350	2	1	J73KN-E- 22	J7KN-200-21□□□ <sup>*2</sup>	1	7.3	

\*1 Coil voltage range and other coil voltages see page 36

\*2 AC and DC in one coil

DC Operated										
Aux. Contacts see page 33			Type	Coil voltage		Pack	Weight	Accept Overload Relay page 56	Busbar Set for Overload Relay page 57	Wiring Diagram
Built-in		Additional		24	24V DC					Coil Circuits see page 35
NO	NC	Type		48	48V DC	pcs	kg/pc.	Type	Type	
				60	60V DC					
				110	110V DC					
				125	125V DC					
				220	220V DC					
1	-	max. 3 J73KN-B <sup>1</sup>	J7KN-10-10□□□D	1	0.25	1	0.25	J7TKN-B	-	-10
-	1		J7KN-10-01□□□D	1	0.25					
1	-		J7KN-14-10□□□D	1	0.25					
-	1		J7KN-14-01□□□D	1	0.25					
1	-		J7KN-18-10□□□D	1	0.25					
-	1		J7KN-18-01□□□D	1	0.25					
1	-	max. 4 J73KN-B	J7KNG-10-10□□□D	1	0.53	1	0.53	J7TKN-B	-	-10
-	1		J7KNG-10-01□□□D	1	0.53					
1	-		J7KNG-14-10□□□D	1	0.53					
-	1		J7KNG-14-01□□□D	1	0.53					
1	-		J7KNG-18-10□□□D	1	0.53					
-	1		J7KNG-18-01□□□D	1	0.53					
1	-	max. 3 J73KN-B <sup>1</sup> + 2 J73KN-C-11S	J7KN-24□□□D	1	0.55	1	0.55	J7TKN-B J7TKN-C	-	-01
-	1		J7KNG-24□□□D	1	0.57					
-	-		J7KN-32□□□D	1	0.55					
-	-		J7KNG-32□□□D	1	0.57					
-	-		J7KN-40□□□D	1	0.55					
-	-		J7KNG-40□□□D	1	0.57					
-	-	max. 3 J73KN-B <sup>1</sup> + 2 J73KN-C-11S	J7KN-50□□□D	1	0.9	1	0.9	J7TKN-D	-	-
-	-		J7KN-62□□□D	1	0.9					
-	-		J7KN-74□□□D	1	0.9					
Aux. Contacts			Type	Coil voltage			Weight	Accept Overload Relay page 56	Busbar Set for Overload Relay page 57	
Built-in				110	110V DC					
NO	NC	Type		220	220V DC		kg/pc.	Type	Type	
2	1	-	J7KN-85-21□□□D	1	1.8	1	1.9	J7TKN-E	-	-21/-22
2	1		J7KN-110-21□□□D	1	1.9					
-	-	max. 3 1 x J73KN-D22 or 1 x J73KN-D11 and 2 x J73KN-D11S	J7KN-151-□□□ <sup>2</sup>	1	4	1	4	J7TKN-F J7TKN-F	J73TK-SU-176	-
-	-		J7KN-176-□□□ <sup>2</sup>	1	4					
2	1	-	J7KN-200-21□□□ <sup>2</sup>	1	7.3	1	7.3	J7TKN-F	J73TK-SU-200	-21
-	-		J7KN-200-21□□□ <sup>2</sup>	1	7.3					

<sup>1</sup> Only 3 additional Aux. Contacts are possible! (See also the wiring diagrams coil circuit DC operated page 35)

<sup>2</sup> AC and DC in one coil

**System Contactors for Fuseless Load Feeders with integrated Link Module** (see page 72)



**AC Operated**

	Ratings			Rated Current AC1 690V A	Aux. Contacts see page 33		Additional see page 33 Type	Type	Pack	Weight
	AC2, AC3 380V 400V 415V kW	500V kW	660V 690V kW		Built-in					
					NO	NC		Coil Voltage <sup>*1</sup> 24V 50/60Hz 110V 50Hz 220-240V 50Hz	pcs.	kg/pc.
	4 5.5 7.5 11	5.5 7.5 10 10	5.5 7.5 10 10	25 25 32 32	1 1 1 1	- - - -	max. 4 J73KN-B	J7KN-10-10 □□□-VK3 J7KN-14-10 □□□-VK3 J7KN-18-10 □□□-VK3 J7KN-22-10 □□□-VK3	1 1 1 1	0.25 0.25 0.25 0.25

\*1 Coil voltage range and other coil voltages see page 36

**Contactors 4-pole**

**AC Operated**

	Ratings		Rated Current AC1 690V A	Aux. Contacts see page 33		Additional see below Type	Type	Pack	Weight
	AC2, AC3 380V 400V 415V kW	AC1 400V kW		Built-in					
				NO	NC		Coil Voltage <sup>*1</sup> 24V 50/60Hz 110V 50Hz 220-240V 50Hz	pcs.	kg/pc.
	4 5.5 7.5 11	17.5 17.5 22 22	25 25 32 32	- - - -	- - - -	max. 4 J73KN-B	J7KN-10-4 □□□ J7KN-14-4 □□□ J7KN-18-4 □□□ J7KN-22-4 □□□	1 1 1 1	0.22 0.22 0.22 0.22
	75 90	159 173	230 250	- -	- -	max. 3 J73KN-D-11F J73KN-D-22F J73KN-D-11S	J7KN-151-4 □□□ J7KN-176-4 □□□	1 1	4.7 4.7

\*1 Coil voltage range and other coil voltages see page 36

**DC Operated**

	Ratings		Rated Current AC1 690V A	Aux. Contacts see page 33		Additional see below Type	Type	Pack	Weight
	AC2, AC3 380V 400V 415V kW	AC1 400V kW		Built-in					
				NO	NC		Coil Voltage <sup>*1</sup> 24V 50/60Hz 110V 50Hz 220-240V 50Hz	pcs.	kg/pc.
	4 5.5 7.5 11	17.5 17.5 22 22	25 25 32 32	- - - -	- - - -	max. 4 J73KN-B	J7KNG-10-4 □□□D J7KNG-14-4 □□□D J7KNG-18-4 □□□D J7KNG-22-4 □□□D	1 1 1 1	0.53 0.53 0.53 0.53



\*1 Coil voltage range and other coil voltages see page 36



**Auxiliary Contact Blocks** for contactors J7KN-10... to -74... type J73KN for low level switching\*1

Front mounting	Rated Operational Current			Contacts				Type	Pack	Weight
	AC15 230V	AC15 400V	AC1 690V	NO	NC	EM	LB			
	A	A	A						pcs.	kg/pc.
	3	2	10	1	-	-	-	<b>J73KN-B-10</b>	10	0.02
	3	2	10	-	1	-	-	<b>J73KN-B-01</b>	10	0.02
	3	2	10	-	-	1	-	<b>J73KN-B-10U</b>	10	0.02
	3	2	10	-	-	-	1	<b>J73KN-B-01U</b>	10	0.02
	6	4	25	1	-	-	-	<b>J73KN-B-10A</b>	10	0.02
	6	4	25	-	1	-	-	<b>J73KN-B-01A</b>	10	0.02

**Auxiliary Contact Blocks** for contactors J7KN-151... to 176... type J73KN for low level switching

	Rated Operational Current			Mounting	Contacts		Type	Pack	Weight
	AC15 230V	AC15 400V	AC1 690V		NO	NC			
	A	A	A					pcs.	kg/pc.
	3	2	10	front	1	1	<b>J73KN-D-11F</b>	1	0.08
	3	2	10		2	2	<b>J73KN-D-22F</b>	1	0.08
	3	2	10	side	1	1	<b>J73KN-D-11S</b>	1	0.12

**Auxiliary Contact Blocks**

for contactors J7KN-24... to KN-74 and J7KN-200... type J73KN for low level switching

	Rated Operational Current			Mounting	Contacts		Type	Pack	Weight
	AC15 230V	AC15 400V	AC1 690V		NO	NC			
	A	A	A					pcs.	kg/pc.
	3	2	10	max. 2 side mounting (J7KN-24-74)	1	1	<b>J73KN-C-11S</b>	10	0.02
	3	2	10	max. 2 front mounting (J7KN-200)	2	2	<b>J73KN-E-22</b>	1	0.12

**Pneumatic Timer** for contactors J7KN-10... to -40...







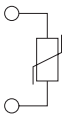

	Function	Time range s	Contacts				Type	Pack	Weight
			NO	NC	NO	NC			
	On-delay	0.1 - 40	1	1	-	-	<b>J74KN-B-TP40DA</b>	1	0.09
	On-delay	10 - 180	1	1	-	-	<b>J74KN-B-TP180DA</b>	1	0.09
	Off-delay	0.1 - 40	-	-	1	1	<b>J74KN-B-TP40IA</b>	1	0.09
	Off-delay	10 - 180	-	-	1	1	<b>J74KN-B-TP180IA</b>	1	0.09

**Mechanical Interlocks**

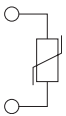
	Interlocks contactor with contactor		Mounting	Type	Pack	Weight
	Type	Type				
	J7KN10 - J7KN40	+ J7KN10 - J7KN40	horizontal	<b>J74KN-B-ML</b>	1	0.006
	J7KN24 - J7KN74	+ J7KN24 - J7KN74	horizontal	<b>J74KN-C-ML</b>	1	0.010
	J7KN85 - J7KN110	+ J7KN85 - J7KN110	horizontal	<b>J74KN-D-ML</b>	1	0.076
	J7KN151 - J7KN176	+ J7KN151 - J7KN176	horizontal	<b>J74KN-E-ML</b>	1	0.076

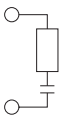
1. suitable according to DIN 19240 (test ratings 17V DC, 5mA) Technical data see page 49

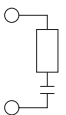
Suppressor Units

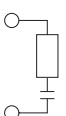
		Suitable for Contactors	Suitable for Coil Voltages		Type	Pack pcs.	Weight kg/pc.
		J7KNA J7KN10-J7KN22	110 - 230 V 250 - 415 V	AC/DC AC/DC	J74KN-A-VG230 J74KN-A-VG400	10 10	0.01 0.01
		J7KN10-J7KN74	110 - 230 V 250 - 415 V	AC/DC AC/DC	J74KN-B-VG230 J74KN-B-VG400	10 10	0.02 0.02
		J7KNA	12 - 48 V 48 - 127 V 110 - 230 V	AC/DC AC/DC AC/DC	J74KN-D-RC24 J74KN-D-RC110 J74KN-D-RC230	10 10 10	0.02 0.036 0.036
		J7KN10-J7KN74	12 - 48 V 48 - 127 V 110 - 230 V	AC/DC AC/DC AC/DC	J74KN-C-RC24 J74KN-C-RC110 J74KN-C-RC230	10 10 10	0.02 0.036 0.036
		J7KN85-J7KN110	24 - 48 V 110 - 250 V 250 - 415 V	AC/DC AC/DC AC/DC	J74KN-B-RC48 J74KN-B-RC230 J74KN-B-RC400	5 5 5	0.04 0.04 0.04

Additional Terminals Single Pole

	For Contactors	Cable Cross-sections to clamp mm <sup>2</sup>			Type	Pack pcs.	Weight kg/pc.
		solid or stranded	flexible	flex. with multi-core cable end			
	J7KN50 - KN74 J7KN151 - KN176	4 - 35 16 - 120	6 - 25 ---	4 - 25 16 - 95	J74KN-LG-9030 J74KN-LG-11224	1	0.052

Terminal Covers for terminal protection according DIN 57106, BVG-A2

	For Contactors	Specification	Type	Pack pcs.	Weight kg/pc.
	J7KN151 - KN176	one unit	J74KN-LG-10404	1	0.12

Marking Systems for contactors J7KNA to J7KN74 and aux. contact blocks J73KN-B

	Description	Specification	Type	Pack pcs.	Weight kg/pc.
	Marking Plate	2-section without marking, divisible	J74KN-P487-1	100	0.025
	Marking Plate	4-section without marking, divisible	J74KN-P245-1	100	0.050

Insulated wiring systems for motor contactors

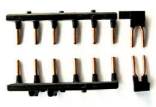
	Description	Version (A)	For contactors	Type	Pack pcs
	For reversing or parallel contactors ( 2 parts )	25	J7KN 10 - 22	<b>J75-WK-21</b>	1
		40	J7KN 24 - 40	<b>J75-WK-41</b>	1
	For star-delta combination (3 parts)	25	J7KN 10 - 22	<b>J75-WK-22</b>	1

■ Wiring Diagrams Coil Circuit

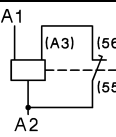
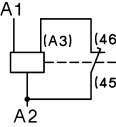
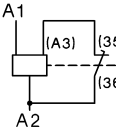
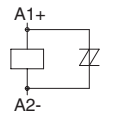
AC operated	DC operated with double winding coil*1
J7KN-10... to J7KN-110...	J7KN-10...D to J7KN-22...D
	
	J7KN-24...D to J7KN-74...D
	
	J7KN-110...D
	
	J7KNG
	

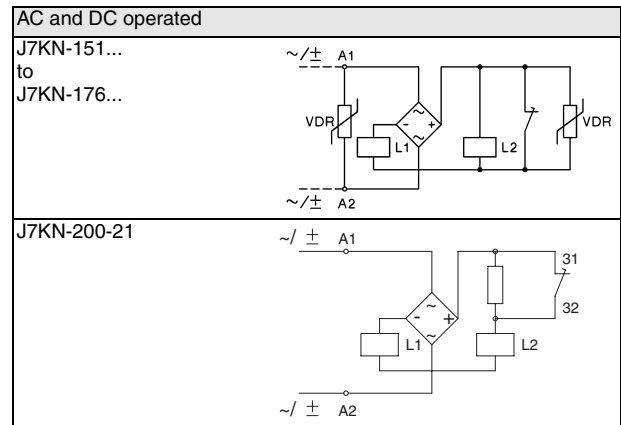

\*1) 3 Additional Aux. Contacts are possible with the J7KN-.....D types! (See also page 31)

# Specifications

## ■ Coil Voltages

Type-suffix for contactor types J7KN-10... to J7KN-74...

Suffix to contactor type e.g.	Voltage Marking at the coil		Rated Control Voltage U <sub>s</sub> range for			
	for 50Hz V	for 60Hz V	50Hz		60Hz	
			min V	max V	min V	max V
<b>J7KN-10-10-24</b>						
<b>24</b>	<b>24</b>	<b>24</b>	<b>22</b>	<b>24</b>	<b>24</b>	<b>27</b>
48	48	48	44	48	48	52
<b>110</b>	<b>110</b>	<b>110-120</b>	<b>100</b>	<b>110</b>	<b>110</b>	<b>122</b>
180	180-210	200-240	180	210	200	240
<b>230</b>	<b>220-240</b>	<b>240</b>	<b>220</b>	<b>240</b>	<b>240</b>	<b>264</b>
<b>400</b>	<b>380-415</b>	<b>415-440</b>	<b>380</b>	<b>415</b>	<b>415</b>	<b>460</b>
500	500-550	550-600	500	550	550	600

Standard voltages in bold type letter

Type-suffix for contactor types J7KN-85... to J7KN-110...

Suffix to contactor type e.g.	Voltage Marking at the coil		Rated Control Voltage U <sub>s</sub> range for			
	for 50Hz V	for 60Hz V	50Hz		60Hz	
			min V	max V	min V	max V
<b>J7KN-85-22-24</b>						
<b>20</b>	<b>20</b>	<b>24</b>	<b>20</b>	<b>22</b>	<b>24</b>	<b>26</b>
<b>24</b>	<b>24</b>		<b>24</b>	<b>27</b>	<b>29</b>	<b>32</b>
48	48	60	47	52	56	62
90	90	110-120	90	100	108	120
<b>110</b>	<b>110-120</b>		<b>110</b>	<b>122</b>	<b>132</b>	<b>146</b>
180	180-200	208-240	180	200	208	240
<b>230</b>	<b>220-240</b>	<b>277</b>	<b>220</b>	<b>240</b>	<b>264</b>	<b>288</b>
<b>400</b>	<b>380-415</b>	<b>460-480</b>	<b>380</b>	<b>415</b>	<b>455</b>	<b>498</b>
500	500-550	600-660	500	550	600	660

Standard voltages in bold type letter

Type-suffix for contactor types J7KN-151... to J7KN-200...

Suffix to contactor type e.g.	Voltage Marking at the coil		Rated Control Voltage U <sub>s</sub> range for				
	for 50 Hz V	for 60 Hz V	50Hz		60Hz		DC
			min V	max V	min V	max V	max V
<b>J7KN-151-230</b>							
<b>24</b>	<b>24</b>	<b>24</b>	<b>24</b>	<b>24</b>	<b>24</b>	<b>24</b>	<b>24</b>
48	48	48	48	48	48	48	48
110	110	120	110	120	110	120	110
<b>230</b>	<b>220-240</b>	<b>220-240</b>	<b>220</b>	<b>240</b>	<b>220</b>	<b>240</b>	<b>220</b>
<b>400</b>	<b>380-415</b>	<b>380-415</b>	<b>380</b>	<b>415</b>	<b>380</b>	<b>415</b>	-

Standard voltages in bold type letter

## Engineering data and characteristics

### Approximate Values for three-phase Motors

#### Motor Full Load Currents

Approximate values of motor F.L.C. and minimum „slow blow“ respectively „gL“ short-circuit fuse

Motor rating					220-230V Motor			240V Motor			380-400V Motor			415V Motor			500V Motor			660-690V Motor		
Range according to BS for 415V					Value of fusing at motor start			Value of fusing at motor start			Value of fusing at motor start			Value of fusing at motor start			Value of fusing at motor start			Value of fusing at motor start		
kW	PS-hp	hp	cos	%	F.L.C. A	D.O.L. A	YD A	F.L.C. A	D.O.L. A	YD A	F.L.C. A	D.O.L. A	YD A	F.L.C. A	D.O.L. A	YD A	F.L.C. A	D.O.L. A	YD A	F.L.C. A	D.O.L. A	YD A
0.06	0.08	-	0.7	59	0.38	1	1	0.35	1	1	0.22	1	1	-	-	-	0.16	1	1	-	-	-
0.09	0.12	-	0.7	60	0.55	2	2	0.5	2	2	0.33	1	1	-	-	-	0.24	1	1	-	-	-
0.12	0.16	-	0.7	61	0.76	2	2	0.68	2	2	0.42	2	2	-	-	-	0.33	1	1	-	-	-
0.18	0.24	-	0.7	61	1.1	2	2	1	2	2	0.64	2	2	-	-	-	0.46	1	1	-	-	-
0.25	0.34	-	0.7	62	1.4	4	2	1.38	4	2	0.88	2	2	-	-	-	0.59	2	2	-	-	-
0.37	0.5	-	0.72	64	2.1	4	4	1.93	4	4	1.22	4	2	-	-	-	0.85	2	2	0.7	2	2
0.55	0.75	-	0.75	69	2.7	4	4	2.3	4	4	1.5	4	2	-	-	-	1.2	4	2	0.9	2	2
0.75	1	1	0.8	74	3.3	6	4	3.1	6	4	2	4	4	2	4	4	1.48	4	2	1.1	2	2
1.1	1.5	1.5	0.83	77	4.9	10	6	4.1	6	6	2.6	4	4	2.5	4	4	2.1	4	4	1.5	4	2
1.5	2	2	0.83	78	6.2	10	10	5.6	10	10	3.5	6	4	3.5	6	4	2.6	4	4	2	4	4
2.2	3	3	0.83	81	8.7	16	10	7.9	16	10	5	10	6	5	10	6	3.8	6	6	2.9	6	4
2.5	3.4	-	0.83	81	9.8	16	16	8.9	16	10	5.7	10	10	-	-	-	4.3	6	6	-	-	-
3	4	4	0.84	81	11.6	20	16	10.6	20	16	6.6	16	10	6.5	16	10	5.1	10	10	3.5	6	4
3.7	5	5	0.84	82	14.2	25	20	13	25	16	8.2	16	10	7.5	16	10	6.2	16	10	-	-	-
4	5.5	-	0.84	82	15.3	25	20	14	25	20	8.5	16	10	-	-	-	6.5	16	10	4.9	10	6
5.5	7.5	7.5	0.85	83	20.6	35	25	18.9	35	25	11.5	20	16	11	20	16	8.9	16	10	6.7	16	10
7.5	10	10	0.86	85	27.4	35	35	24.8	35	35	15.5	25	20	14	25	16	11.9	20	16	9	16	10
8	11	-	0.86	85	28.8	50	35	26.4	35	35	16.7	25	20	-	-	-	12.7	20	16	-	-	-
11	15	15	0.86	87	39.2	63	50	35.3	50	50	22	35	25	21	35	25	16.7	25	20	13	25	16
12.5	17	-	0.86	87	43.8	63	50	40.2	63	50	25	35	35	-	-	-	19	35	25	-	-	-
15	20	20	0.86	87	52.6	80	63	48.2	80	63	30	50	35	28	35	35	22.5	35	25	17.5	25	20
18.5	25	25	0.86	88	64.9	100	80	58.7	80	63	37	63	50	35	50	50	28.5	50	35	21	35	25
20	27	-	0.86	88	69.3	100	80	63.4	80	80	40	63	50	-	-	-	30.6	50	35	-	-	-
22	30	30	0.87	89	75.2	100	80	68	100	80	44	63	50	40	63	50	33	50	50	25	35	35
25	34	-	0.87	89	84.4	125	100	77.2	100	100	50	80	63	-	-	-	38	63	50	-	-	-
30	40	40	0.87	90	101	125	125	92.7	125	100	60	80	63	55	80	63	44	63	50	33	50	35
37	50	50	0.87	90	124	160	160	114	160	125	72	100	80	66	100	80	54	80	63	42	63	50
40	54	-	0.87	90	134	160	160	123	160	160	79	100	100	-	-	-	60	80	63	-	-	-
45	60	60	0.88	91	150	200	160	136	200	160	85	125	100	80	100	100	64.5	100	80	49	63	63
51	70	-	0.88	91	168	200	200	154	200	200	97	125	100	-	-	-	73.7	100	80	-	-	-
55	75	-	0.88	91	181	250	200	166	200	200	105	160	125	-	-	-	79	125	100	60	80	63
59	80	80	0.88	91	194	250	250	178	250	200	112	160	125	105	160	125	85.3	125	100	-	-	-
75	100	100	0.88	91	245	315	250	226	315	250	140	200	160	135	200	160	106	160	125	82	125	100
90	125	125	0.88	92	292	400	315	268	315	315	170	250	200	165	200	200	128	160	160	98	125	125
110	150	150	0.88	92	358	500	400	327	400	400	205	250	250	200	250	250	156	200	200	118	160	125
129	175	175	0.88	92	420	500	500	384	500	400	242	315	250	230	315	250	184	250	200	-	-	-
132	180	-	0.88	92	425	500	500	393	500	500	245	315	250	-	-	-	186	250	200	140	200	160
147	200	200	0.88	93	472	630	630	432	630	500	273	315	315	260	315	315	207	250	250	-	-	-
160	220	-	0.88	93	502	630	630	471	630	630	295	400	315	-	-	-	220	315	250	170	200	200
184	250	250	0.88	93	590	800	630	541	630	630	340	400	400	325	400	400	259	315	315	-	-	-
200	270	-	0.88	93	626	800	800	589	800	630	370	500	400	-	-	-	278	315	315	215	250	250
220	300	300	0.88	93	700	1000	800	647	800	800	408	500	500	385	500	400	310	400	400	-	-	-
250	340	-	0.88	93	803	1000	1000	736	1000	800	460	630	500	-	-	-	353	500	400	268	315	315
257	350	350	0.88	93	826	1000	1000	756	1000	800	475	630	630	450	630	500	363	500	400	-	-	-
295	400	400	0.88	93	948	1250	1000	868	1000	1000	546	800	630	500	630	630	416	500	500	-	-	-
315	430	-	0.88	93	990	1250	1250	927	1250	1000	580	800	630	-	-	-	445	630	500	337	400	400
355	483	-	0.89	95	-	-	-	-	-	-	636	800	800	-	-	-	483	630	630	366	500	400
400	545	-	0.89	96	-	-	-	-	-	-	710	1000	800	-	-	-	538	630	630	410	500	500

The motor F.L.C. be valid for standard internal and surface cooled three-pole motors with 1500 min<sup>-1</sup>. The fuses values be valid for the motor F.L.C. shown in the table and D.O.L.-start: starting current max. 6x motor F.L.C., starting time max. 5s; star-delta-start: starting current max. 2x motor F.L.C., starting time max. 15s. For motors with higher F.L.C., higher starting current and / or longer starting time, larger short-circuit fuses are required.

The maximum admissible value is dependent on the switchgear respectively thermal overload relay.

Approximate values of motor F.L.C. according to CSA and UL

Motor rating hp	Motor F.L.C. at 110-120V			Motor F.L.C. at 220-240V <sup>*1</sup>			Motor F.L.C. at 440-480V			Motor F.L.C. at 550-600V		
	1-phase A	2-phase A	3-phase A	1-phase A	2-phase A	3-phase A	1-phase A	2-phase A	3-phase A	1-phase A	2-phase A	3-phase A
½	9.8	4.0	4.4	4.9	2.0	2.2	2.5	1.0	1.1	2.0	0.8	0.9
¾	13.8	4.8	6.4	6.9	2.4	3.2	3.5	1.2	1.6	2.8	1.0	1.3
1	16.0	6.4	8.4	8.0	3.2	4.2	4.0	1.6	2.1	3.2	1.3	1.7
1½	20.0	9.0	12.0	10.0	4.5	6.0	5.0	2.3	3.0	4.0	1.8	2.4
2	24.0	11.8	13.6	12.0	5.9	6.8	6.0	3.0	3.4	4.8	2.4	2.7
3	34.0	16.6	19.2	17.0	8.3	9.6	8.5	4.2	4.8	6.8	3.3	3.9
5	56.0	26.4	30.4	28.0	13.2	15.2	14.0	6.6	7.6	11.2	5.3	6.1
7½	80.0	38.0	44.0	40.0	19.0	22.0	21.0	9.0	11.0	16.0	8.0	9.0
10	100.0	48.0	56.0	50.0	24.0	28.0	26.0	12.0	14.0	20.0	10.0	11.0
15	135.0	72.0	84.0	68.0	36.0	42.0	34.0	18.0	21.0	27.0	14.0	17.0
20	-	94.0	108.0	88.0	47.0	54.0	44.0	23.0	27.0	35.0	19.0	22.0
25	-	118.0	136.0	110.0	59.0	68.0	55.0	29.0	34.0	44.0	24.0	27.0
30	-	138.0	160.0	136.0	69.0	80.0	68.0	35.0	40.0	54.0	28.0	32.0
40	-	180.0	208.0	176.0	90.0	104.0	88.0	45.0	52.0	70.0	36.0	41.0
50	-	226.0	260.0	216.0	113.0	130.0	108.0	56.0	65.0	86.0	45.0	52.0
60	-	-	-	-	133.0	145.0	-	67.0	77.0	-	53.0	62.0
75	-	-	-	-	166.0	192.0	-	83.0	96.0	-	66.0	77.0
100	-	-	-	-	218.0	248.0	-	109.0	124.0	-	87.0	99.0
125	-	-	-	-	-	312.0	-	135.0	156.0	-	108.0	125.0
150	-	-	-	-	-	360.0	-	156.0	180.0	-	125.0	144.0
200	-	-	-	-	-	480.0	-	208.0	240.0	-	167.0	192.0
250	-	-	-	-	-	602.0	-	-	302.0	-	-	242.0
300	-	-	-	-	-	-	-	-	361.0	-	-	289.0
350	-	-	-	-	-	-	-	-	414.0	-	-	336.0
400	-	-	-	-	-	-	-	-	477.0	-	-	382.0
500	-	-	-	-	-	-	-	-	590.0	-	-	472.0

\*1 Determine the motor current for 200V and 208V by increasing the values for 220-240V at 200V about 15% and for 208V about 10%.

**Contactors**

**Data according to IEC 947-4-1, EN 60947-4-1, VDE 0660**

Main Contacts	Type	J7KN-10	J7KN-14	J7KN-18	J7KN-22	J7KN-24	J7KN-32	J7KN-40	J7KN-50	J7KN-62	J7KN-74
Rated insulation voltage $U_i$ <sup>1)</sup>	V AC	690	690	690	690	690	690	690	690	690	690
Making capacity $I_m$	at $U_i = 690V$ AC A	200	200	200	200	400	500	500	700	900	900
Breaking capacity $I_{br}$	400V AC A	180	180	200	200	380	400	400	600	800	800
	J7KN-10 to J7KN-22 $\cos\phi = 0,65$	150	150	180	180	300	370	370	500	700	700
	J7KN-24 to J7KN-72 $\cos\phi = 0,35$	100	100	150	150	260	340	340	400	500	500
	1000V AC A	-	-	-	-	-	-	-	-	-	-
<b>Utilization category AC1</b>											
<b>Switching of resistive load</b>											
Rated operational current $I_n (=I_{th})$ at 40°C, open	<b>A</b>	<b>25</b>	<b>25</b>	<b>32</b>	<b>32</b>	<b>50</b>	<b>65</b>	<b>80</b>	<b>110</b>	<b>120</b>	<b>130</b>
Rated operational power of three-phase resistive loads 50-60Hz, $\cos\phi = 1$	220V kW	9,5	9,5	12,2	12,2	19,0	24,7	30,4	41,9	45,7	49,5
	230V kW	9,9	9,9	12,7	12,7	19,9	25,9	31,8	43,8	47,7	51,7
	240V kW	10,4	10,4	13,3	13,3	20,8	27,0	33,2	45,7	49,8	54,0
	380V kW	16,4	16,4	21,0	21,0	32,9	42,7	52,6	72,3	78,9	85,5
	400V kW	17,3	17,3	22,1	22,1	34,6	45,0	55,4	76,1	83,0	90,0
	415V kW	17,9	17,9	23,0	23,0	35,9	46,7	57,4	79,0	86,2	93,3
	440V kW	19,0	19,0	24,4	24,4	38,1	49,5	60,9	83,7	91,3	99,0
	500V kW	21,6	21,6	27,7	27,7	43,3	56,2	69,2	95,2	103,8	112,5
	660V kW	28,5	28,5	36,5	36,5	57,1	74,2	91,3	125,6	137,0	148,4
	690V kW	29,8	29,8	38,2	38,2	59,7	77,6	95,5	131,3	143,2	155,2
	1000V kW	-	-	-	-	-	-	-	-	-	-
Rated operational current $I_n (=I_{th})$ at 60°C, enclosed	A	25	25	32	32	40	55	65	90	100	110
Rated operational power of three-phase resistive loads 50-60Hz, $\cos\phi = 1$	220V kW	9,5	9,5	12,2	12,2	15,2	20,9	24,7	34,3	38,1	41,9
	230V kW	9,9	9,9	12,7	12,7	15,9	21,9	25,9	35,8	39,8	43,8
	240V kW	10,4	10,4	13,3	13,3	16,6	22,8	27,0	37,4	41,5	45,7
	380V kW	16,4	16,4	21,0	21,0	26,3	36,2	42,7	59,2	65,7	72,3
	400V kW	17,3	17,3	22,1	22,1	27,7	38,1	45,0	62,3	69,2	76,1
	415V kW	17,9	17,9	23,0	23,0	28,7	39,5	46,7	64,6	71,8	79,0
	440V kW	19,0	19,0	24,4	24,4	30,4	41,9	49,5	68,5	76,1	83,7
	500V kW	21,6	21,6	27,7	27,7	34,6	47,6	56,2	77,9	86,5	95,2
	660V kW	28,5	28,5	36,5	36,5	45,7	62,8	74,2	102,8	114,2	125,6
	690V kW	29,8	29,8	38,2	38,2	47,7	65,7	77,6	107,4	119,4	131,3
	1000V kW	-	-	-	-	-	-	-	-	-	-
Minimum cross-section of conductor at load with $I_n (=I_n)$	mm <sup>2</sup>	4	4	6	6	10	16	25	35	50	50
<b>Utilization category AC2 and AC3</b>											
<b>Switching of three-phase motors</b>											
Rated operational current $I_n$ open and enclosed	220V A	12	15	18	22	24	30	40	50	63	74
	230V A	11,5	14,5	18	22	24	30	40	50	62	74
	240V A	11	14	18	22	24	32	40	50	62	74
	<b>380-400V A</b>	<b>10</b>	<b>14</b>	<b>18</b>	<b>22</b>	<b>24</b>	<b>32</b>	<b>40</b>	<b>50</b>	<b>62</b>	<b>74</b>
	415V A	9	14	18	22	23	30	40	50	62	74
	440V A	9	14	18	22	23	30	40	50	62	74
	500V A	7	9	9	9	17,5	21	21	33	42	42
	660-690V A	6,5	8,5	8,5	8,5	17	20	20	31	40	40
	1000V A	-	-	-	-	-	-	-	-	-	-
Rated operational power of three-phase motors 50-60Hz	220-230V kW	3	4	5	6	6	8,5	11	12,5	18,5	22
	240V kW	3	4	5	7	7	9	11,5	13,5	19	23
	<b>380-400V kW</b>	<b>4</b>	<b>5,5</b>	<b>7,5</b>	<b>11</b>	<b>11</b>	<b>15</b>	<b>18,5</b>	<b>22</b>	<b>30</b>	<b>37</b>
	415V kW	4,5	6	8,5	12	12	16	20	24	33	40
	440V kW	4,5	6	8,5	12	12	16	20	24	33	40
	500V kW	5,5	7,5	10	10	15	18,5	18,5	30	37	45
	660-690V kW	5,5	7,5	10	10	15	18,5	18,5	30	37	45
	1000V kW	-	-	-	-	-	-	-	-	-	-
<b>Utilization category AC4</b>											
<b>Switching of squirrel cage motors, inching</b>											
Rated operational current $I_n (=I_n)$ open and enclosed	220V A	12	15	18	18	24	30	40	50	63	63
	230V A	11,5	14,5	18	18	24	30	40	50	62	62
	240V A	11	14	18	18	24	32	40	50	62	62
	<b>380-400V A</b>	<b>10</b>	<b>14</b>	<b>18</b>	<b>18</b>	<b>24</b>	<b>32</b>	<b>40</b>	<b>50</b>	<b>62</b>	<b>62</b>
	415V A	9	14	18	18	23	30	37	45	60	60
	440V A	9	14	18	18	23	30	37	45	55	55
	500V A	9	12	16	16	17,5	21	21	33	42	42
	660V A	7	9	9	9	17	20	20	31	40	40
	690V A	6,5	8,5	8,5	8,5	17	20	20	31	40	40
	1000V A	-	-	-	-	-	-	-	-	-	-

Main Contacts		Type	J7KN-10	J7KN-14	J7KN-18	J7KN-22	J7KN-24	J7KN-32	J7KN-40	J7KN-50	J7KN-62	J7KN-74
<b>Utilization category AC4</b>												
<b>Switching of squirrel cage motors, inching</b>												
Rated operational power of three-phase motors 50-60Hz	220-230V	kW	3	4	5	5	6	8,5	11	12,5	18,5	18,5
	240V	kW	3	4	5	5	7	9	11,5	13,5	19	19
	<b>380-400V</b>	<b>kW</b>	<b>4</b>	<b>5,5</b>	<b>7,5</b>	<b>7,5</b>	<b>11</b>	<b>15</b>	<b>18,5</b>	<b>22</b>	<b>30</b>	<b>30</b>
	415V	kW	4,5	6	8,5	8,5	12	16	20	24	33	33
	440V	kW	4,5	6	8,5	8,5	12	16	20	24	33	33
	500V	kW	5,5	7,5	10	10	15	18,5	18,5	30	37	37
	660-690V	kW	5,5	7,5	10	10	15	18,5	18,5	30	37	37
1000V	kW	-	-	-	-	-	-	-	-	-	-	
<b>Utilization category AC 5a</b>												
<b>Switching of gas discharge lamps</b>												
Rated operational current I <sub>e</sub> per pole at 220/230V												
Fluorescent lamps,												
uncompensated and serial compensated	A	20	20	25	25	40	52	64	88	96	104	104
parallel compensated	A	7	9	9	9	18	22	22	30	40	45	45
dual-connection	A	22,5	22,5	28	28	45	58	72	98	108	117	117
Metal halide lamps <sup>2</sup> ,												
uncompensated	A	12	15	19	19	30	39	48	66	72	78	78
parallel compensated	A	7	9	9	9	18	22	22	30	40	45	45
Mercury-vapour lamps <sup>3</sup> ,												
uncompensated	A	22,5	25	28	28	45	58	72	99	108	117	117
parallel compensated	A	7	9	9	9	18	22	22	30	40	45	45
Mixed light lamps <sup>4</sup>												
	A	20	20	25	25	40	52	64	88	96	104	104
<b>Utilization category AC 5b</b>												
<b>Switching of incandescent lamps<sup>5</sup></b>												
Rated operational current I <sub>e</sub> per pole at 220/230V	A	12,5	12,5	12,5	12,5	25	31	31	43	56	56	56
<b>Utilization category AC 6a</b>												
<b>Transformer primary switching</b>												
at inrush	n	30	30	30	30	30	30	30	30	30	30	30
Rated operational current I <sub>e</sub>	400V	A	4,5	5,5	7,5	7,5	10,5	13,5	13,5	20	27	33
Rated operational power dependent on inrush n	220-230V	kVA	1,8	2,2	3	3	4,2	5,4	5,4	8	10,7	13
	240V	kVA	1,9	2,3	3,1	3,1	4,3	5,6	5,6	8,3	11,2	13,5
	380-400V	kVA	3,1	3,8	5,2	5,2	7,3	9,3	9,3	13,5	18,5	22,5
For different inrush-factors x use the following formula: Px=Pn*(n/x)	415-440V	kVA	3,4	4,2	5,7	5,7	8	10,2	10,2	15	20,5	25
	500V	kVA	3,9	4,8	6,5	6,5	9	11,5	11,5	17	23	28
	660-690V	kVA	5,4	6,5	9	9	12,5	16	16	24	32	39
<b>Utilization category AC 6b</b>												
<b>Switching of three-phase capacitor banks</b>												
Maximum inrush current (peak value) as multiple k of the capacitor rated current	k	35	25	20	20	25	25	25	25	25	25	20
Rated operational current I <sub>e</sub>	500V	A	8	12	15,5	15,5	23	32	32	45	60	70
Rated operational power (sin <sup>-1</sup> )	220-230V	kVA	3	4,5	6	6	8,5	12	12	17	24	28
	240V	kVA	3,5	5	6,5	6,5	9,5	13	13	18,5	25	29
	380-400V	kVA	5	7,5	10	10	15	20	20	29	39	46
For different multiples x use the following formula: Px=Pk*(k/x)	415-440V	kVA	5,5	8	11	11	16	22	22	32	43	50
	500V	kVA	7	10	13	13	20	26	26	39	50	58
	660-690V	kVA	7	10	13	13	20	26	26	40	50	58
<b>Switching of detuned capacitors</b>												
Rated operational current I <sub>e</sub>	690V	A	8	13	18	20	28	36	42	48	72	105 <sup>1)</sup>
Rated operational power	220-230V	kVA	2,9	5	7	7,5	11	14	16	20	28	33
	240V	kVA	3,1	5,4	7	8	11	14	17	20	28	36
	380-400V	kVA	5	9	12,5	13	20	25	27,5	33,3	50	75 <sup>1)</sup>
	415-440V	kVA	5,5	9,5	13	14	22	27	30	36	53	75 <sup>1)</sup>
	500V	kVA	6	11	15	17	25	30	36	40	60	75
	660-690V	kVA	8	15	20	22	33	41	48	55	82	100
<b>Utilization category DC1</b>												
<b>Switching of resistive load</b>												
Time constant L/R 1ms												
Rated operational current I <sub>e</sub>	1 pole 24V	A	20	25	32	32	50	65	80	110	120	130
	60V	A	20	25	32	32	50	65	80	110	120	130
	110V	A	6	6	6	6	10	10	10	12	12	12
	220V	A	0,8	0,8	0,8	0,8	1,4	1,4	1,4	1,4	1,4	1,4
	3 poles in series 24V	A	20	25	32	32	50	65	80	110	120	130
	60V	A	20	25	32	32	50	65	80	110	120	130
	110V	A	20	25	32	32	50	65	80	110	120	130
	220V	A	16	20	20	20	30	35	35	63	80	80



Main Contacts	Type	J7KN-10	J7KN-14	J7KN-18	J7KN-22	J7KN-24	J7KN-32	J7KN-40	J7KN-50	J7KN-62	J7KN-74	
<b>Utilization category DC3 and DC5</b>												
<b>Switching of shunt motors and series motors</b>												
Time constant L/R 15ms												
Rated operational current I <sub>o</sub>	1 pole 24V A	20	25	32	32	50	65	80	110	120	130	
	60V A	6	6	6	6	30	30	30	60	60	60	
	110V A	1,2	1,2	1,2	1,2	1,8	1,8	1,8	1,8	1,8	1,8	
	220V A	0,2	0,2	0,2	0,2	0,2	0,2	0,2	0,25	0,25	0,25	
	3 poles in series 24V A	20	25	32	32	50	65	80	110	120	130	
	60V A	20	25	32	32	40	40	40	80	80	80	
	110V A	20	20	20	20	40	40	40	80	80	80	
	220V A	2,5	2,5	2,5	2,5	4	4	4	5	5	5	
<b>Maximum ambient temperature</b>												
Operation	open °C	-40 to +60 (+90) <sup>6</sup>										
	enclosed °C	-40 to +40										
with thermal overload relay	open °C	-25 to +60										
	enclosed °C	-25 to +40										
Storage	°C	-50 to +90										
<b>Short circuit protection</b>												
for contactors without thermal overload relay												
Coordination-type "1" according to IEC 947-4-1												
Contact welding without hazard of persons												
max. fuse size	gL (gG) A	63	63	63	63	80	80	80	160	160	160	
Coordination-type "2" according to IEC 947-4-1												
Light contact welding accepted												
max. fuse size	gL (gG) A	25	35	35	35	50	50	50	100	125	125	
Contact welding not accepted												
max. fuse size	gL (gG) A	16	16	16	16	25	35	35	50	63	63	
For contactors with thermal overload relay the device with the smaller admissible backup fuse (contactor or thermal overload relay) determines the fuse size.												
<b>Cable cross-sections</b>												
for contactors without thermal overload relay												
main connector	solid or stranded mm <sup>2</sup>	0,75 - 6				1,5 - 25			4 - 50			
	flexible mm <sup>2</sup>	1 - 4				2,5 - 16			10 - 35			
	flexible with multicore cable end mm <sup>2</sup>	0,75 - 4				1,5 - 16			6 - 35			
Cables per clamp		2				1			1			
	solid or stranded mm <sup>2</sup>	6+(1-6) / 4+(0,75-4)				16+(2,5-6) / 10+(4-10)			50+4 / 35+6 / 25+(6-16)			
	flexible mm <sup>2</sup>	6+(1,5-6) / 4+(1-4)				16+(2,5-6) / 10+(4-10)			50+(4-10) / 35+(4-16)			
Cables per clamp		2,5+(0,75-2,5) / 1,5+(0,75-1,5)				6+(4-6) / 4+(2,5-4)			16+(6-16) / 10+(6-16)			
		2,5+(0,75-2,5) / 1,5+(0,75-1,5)				6+(4-6) / 4+(2,5-4)			25+(4-25) / 16+(4-16)			
		2				2			2			
main connector	solid AWG	18 - 10				16 - 10			12 - 10			
	flexible AWG	18 - 10				14 - 4			10 - 0			
		2				1			1			
Cables per clamp	solid AWG	10+(16-10) / 12+(18-12)				10+(16-10) / 12+(18-12)			10+(12-10) / 12+12			
		14+(18-14) / 16+(18-16)				14+(18-14) / 16+(18-16)			1+(12-10) / 2+(8-12)			
	flexible AWG	10+(14-10) / 12+(18-12)				4+(18-12) / 6+(18-8)			3+(12-8) / 4+(10-6)			
Cables per clamp		14+(18-14) / 16+(18-16)				8+(18-8) / 10+(18-12)			2			
		2				2			2			
		2				2			2			
<b>Frequency of operations z</b>												
Contactors without thermal overload relay												
	without load 1/h	10000	10000	10000	10000	7000	7000	7000	7000	7000	7000	
	AC3, I <sub>o</sub> 1/h	600	600	600	600	600	600	600	400	400	400	
	AC4, I <sub>o</sub> 1/h	120	120	120	120	120	120	120	120	120	120	
	DC3, I <sub>o</sub> 1/h	600	600	600	600	600	600	600	400	400	400	
<b>Mechanical life</b>												
AC operated	S x 10 <sup>6</sup>	10	10	10	10	10	10	10	10	10	10	
DC operated	S x 10 <sup>6</sup>	10	10	10	10	10	10	10	10	10	10	
DC solenoid operated	S x 10 <sup>6</sup>	50	50	50	50	50	50	50	-	-	-	
<b>Short time current</b>	10s-current A	96	120	144	176	184	240	296	360	504	592	
<b>Power loss per pole</b>	at I <sub>o</sub> /AC3 400V W	0,21	0,35	0,5	0,75	0,7	1,3	2	2,2	3,9	5,5	
<b>Resistance to shock acc. to IEC 68-2-27</b>												
Shock time 20ms sine-wave	NO g	10	10	10	10	8	8	8	8	8	8	
	NC g	6	6	6	6	-	-	-	-	-	-	

<sup>1</sup> Suitable at 690V for: earthed-neutral systems, overvoltage I to IV, pollution degree 3 (standard-industry): U<sub>imp</sub> = 8kV. Data for other conditions on request.

<sup>2</sup> Metal halide lamps and sodium-vapour lamps (high- and low-pressure lamps)

<sup>3</sup> High-pressure lamps

<sup>4</sup> Blended lamps, containing a mercury high-pressure unit and a tungsten helix in a fluorescent glass bulb (daylight lamps)

<sup>5</sup> Current inrush approx. 16 x I<sub>o</sub>

<sup>6</sup> With reduced control voltage range 0,9 up to 1,0 x U<sub>s</sub> and with reduced rated current I<sub>o</sub>/AC1 according to I<sub>o</sub>/AC3

Main Contacts		Type	J7KN-85	J7KN-110	J7KN-151	J7KN-176	J7KN-200	
Rated insulation voltage $U_n$	V AC		750	750	690	690	690	
Making capacity $I_m$	at $U_n = 690V$ AC A		1100	1200	1500	1800	1700	
Breaking capacity $I_b$	400V AC A		950	1100	1200	1400	1600	
	500V AC A		850	1000	1200	1400	1600	
J7KN-10 to J7KN-22 $\cos\phi = 0,65$	690V AC A		600	600	700	800	1200	
J7KN-24 to J7KN-72 $\cos\phi = 0,35$	1000V AC A		-	-	-	-	-	
<b>Utilization category AC1</b>								
<b>Switching of resistive load</b>								
Rated operational current $I_n (=I_n)$ at 40°C, open	A		150	170	230	250	350	
Rated operational power of three-phase resistive loads 50-60Hz, $\cos\phi = 1$	220V kW		57	64	87	95	133	
	230V kW		59	67	91	99	139	
	240V kW		62	70	95	103	145	
	380V kW		98	111	151	164	230	
	400V kW		103	117	159	173	242	
	415V kW		107	122	165	179	251	
	440V kW		114	129	175	190	266	
	500V kW		130	147	199	216	303	
	660V kW		171	194	262	285	400	
	690V kW		179	203	274	298	418	
	1000V kW		-	-	398	433	-	
Rated operational current $I_n (=I_n)$ at 60°C, enclosed	A		100	125	180	200	280	
Rated operational power of three-phase resistive loads 50-60Hz, $\cos\phi = 1$	220V kW		38	47	68	76	106	
	230V kW		40	49	71	79	111	
	240V kW		41	52	74	83	116	
	380V kW		65	82	118	131	184	
	400V kW		69	86	124	138	193	
	415V kW		71	89	129	143	201	
	440V kW		71	95	137	152	213	
	500V kW		86	108	155	173	242	
	660V kW		114	142	205	228	320	
	690V kW		119	149	215	239	334	
	1000V kW		-	-	-	-	-	
Minimum cross-section of conductor at load with $I_n (=I_n)$	mm <sup>2</sup>		50	70	95	120	185	
<b>Utilization category AC2 and AC3</b>								
<b>Switching of three-phase motors</b>								
Rated operational current $I_n$ open and enclosed	220V A		85	110	150	175	210	
	230V A		85	110	150	175	210	
	240V A		85	110	150	175	210	
	380-400V A		85	110	150	175	210	
	415V A		85	110	150	175	210	
	440V A		85	110	150	175	210	
	500V A		60	60	150	175	210	
	660-690V A		57,5	57,5	120	140	150	
		1000V A		-	-	60	70	-
	Rated operational power of three-phase motors 50-60Hz	220-230V kW		25	33	40	50	60
240V kW			27	35	45	55	65	
380-400V kW			45	55	75	90	110	
415V kW			49	63	80	95	115	
440V kW			49	63	85	100	125	
500V kW			55	75	90	100	132	
660-690V kW			55	55	110	132	132	
	1000V kW		-	-	75	90	-	
<b>Utilization category AC4</b>								
<b>Switching of squirrel cage motors, inching</b>								
Rated operational current $I_n (=I_n)$ open and enclosed	220V A		85	98	55	63	85	
	230V A		85	98	55	63	85	
	240V A		85	98	55	63	85	
	380-400V A		85	85	55	63	85	
	415V A		85	85	55	63	85	
	440V A		85	85	55	63	85	
	500V A		85	85	-	-	-	
	660V A		60	60	-	-	-	
	690V A		57,5	57,5	-	-	-	
		1000V A		-	-	-	-	

Main Contacts		Type	J7KN-85	J7KN-110	J7KN-151	J7KN-176	J7KN-200
Rated operational power of three-phase motors 50-60Hz	220-230V	kW	25	30	15	18,5	25
	240V	kW	27	32	15,5	19	26
	380-400V	kW	45	45	25	30	45
	415V	kW	49	49	25	33	45
	440V	kW	49	49	30	34	48
	500V	kW	55	55	25	30	55
	660-690V	kW	55	55	25	30	55
	1000V	kW	-	-	-	-	-
<b>Utilization category AC 5a</b>							
<b>Switching of gas discharge lamps</b>							
Rated operational current I <sub>o</sub> per pole at 220/230V							
Fluorescent lamps,							
uncompensated and serial compensated	A	100	120	120	140	180	
parallel compensated	A	55	70	85	100	120	
dual-connection	A	112	144	120	140	180	
Metal halide lamps <sup>2</sup> ,							
uncompensated	A	85	90	95	110	140	
parallel compensated	A	55	70	75	85	110	
Mercury-vapour lamps <sup>3</sup> ,							
uncompensated	A	112	144	120	140	180	
parallel compensated	A	55	70	75	85	110	
Mixed light lamps <sup>4</sup>	A	100	120	100	120	160	
<b>Utilization category AC5b</b>							
<b>Switching of incandescent lamps<sup>5</sup></b>							
Rated operational current I <sub>o</sub> per pole at 220/230V	A	69	75	100	120	160	
<b>Utilization category AC6a</b>							
<b>Transformer primary switching</b>							
at inrush	n	30	30	30	30	30	
Rated operational current I <sub>o</sub>	400V A	38	50	65	80	90	
Rated operational power dependent on inrush n	220-230V kVA	15	20	25	30	34	
	240V kVA	15,5	20,5	27	33	37	
	380-400V kVA	26	34	45	55	60	
For different inrush-factors x use the following formula: P <sub>x</sub> =P <sub>n</sub> *(n/x)	415-440V kVA	29	38	46	57	63	
	500V kVA	33	43	55	69	75	
	660-690V kVA	45	60	56	69	100	
<b>Utilization category AC6b</b>							
<b>Switching of three-phase capacitor banks</b>							
Maximum inrush current (peak value) as multiple k of the capacitor rated current	k	20	20	20	20	15	
Rated operational current I <sub>o</sub>	500V A	87	100	120	155	195	
Rated operational power (sin <sup>2</sup> 1)	220-230V kVAr	33	38	45	60	75	
	240V kVAr	36	42	52	62	78	
	380-400V kVAr	57	65	80	100	130	
For different multiples x use the following formula: P <sub>x</sub> =P <sub>k</sub> *(k/x)	415-440V kVAr	60	70	95	110	135	
	500V kVAr	70	80	100	130	170	
	660-690V kVAr	70	80	100	130	170	
<b>Switching of detuned capacitors</b>							
Rated operational current I <sub>o</sub>	690V A	98	105	115	140	200	
Rated operational power	220-230V kVAr	35	40	43	53	76	
	240V kVAr	39	43	45	55	80	
	380-400V kVAr	68	75	75	90	130	
	415-440V kVAr	71	77	80	100	140	
	500V kVAr	85	90	95	120	170	
	660-690V kVAr	110	120	125	150	200	
<b>Utilization category DC1</b>							
<b>Switching of resistive load</b>							
Time constant L/R 1ms							
Rated operational current I <sub>o</sub>	1 pole 24V A	60V A	150	170	-	-	-
		110V A	20	25	-	-	-
		220V A	2	2,5	-	-	-
		60V A	150	170	-	-	-
	3 poles in series 24V A	60V A	150	170	-	-	-
		110V A	150	170	-	-	-
		220V A	100	160	-	-	-

Main Contacts		Type	J7KN-85	J7KN-110	J7KN-151	J7KN-176	J7KN-200
<b>Utilization category DC3 and DC5</b>							
<b>Switching of shunt motors and series motors</b>							
Time constant L/R 15ms							
Rated operational current I <sub>o</sub>	1 pole 24V A	60V A	150	170	-	-	-
		110V A	85	110	-	-	-
		220V A	2	2,5	-	-	-
		220V A	0,5	0,5	-	-	-
	3 poles in series 24V A	60V A	150	170	-	-	-
		110V A	100	110	-	-	-
		110V A	100	110	-	-	-
		220V A	7	8	-	-	-
<b>Maximum ambient temperature</b>							
Operation	open °C	-40 to +60 (+90) <sup>6</sup>			-25 to +55 (+70) <sup>7</sup>		
	enclosed °C	-40 to +40			-25 to +40		
with thermal overload relay	open °C	-25 to +60			-25 to +55		
	enclosed °C	-25 to +40			-25 to +40		
Storage	°C	-50 to +90			-55 to +80		
<b>Short circuit protection</b>							
for contactors without thermal overload relay							
Coordination-type *1* according to IEC 947-4-1							
Contact welding without hazard of persons							
max. fuse size	gL (gG) A	250	250	250	315	400	
Coordination-type *2* according to IEC 947-4-1							
Light contact welding accepted							
max. fuse size	gL (gG) A	160	200	200	250	315	
Contact welding not accepted							
max. fuse size	gL (gG) A	100	125	160	200	250	
For contactors with thermal overload relay the device with the smaller admissible backup fuse (contactor or thermal overload relay) determines the fuse size.							
<b>Cable cross-sections</b>							
for contactors without thermal overload relay							
main connector	solid or stranded mm <sup>2</sup>	10 - 70 <sup>8</sup>	10 - 70 <sup>8</sup>	95	120	185	
	flexible mm <sup>2</sup>	6 - 50 <sup>8</sup>	16 - 50 <sup>8</sup>	screw	screw	screw	
	flexible with multicore cable end mm <sup>2</sup>	10 - 35	10 - 35	M8	M8	M8	
Cables per clamp	solid or stranded mm <sup>2</sup>						
	flexible mm <sup>2</sup>						
main connector	solid AWG	10	10				
	flexible AWG	6 - 0	6 - 0				
	flexible AWG	1	1				
	flexible AWG						
Cables per clamp	solid AWG						
	flexible AWG						
<b>Frequency of operations z</b>							
Contactors without thermal overload relay							
	without load 1/h	3000	3000	1200	1200	1200	
	AC3, I <sub>e</sub> 1/h	300	300	-	-	-	
	AC4, I <sub>e</sub> 1/h	120	120	-	-	-	
	DC3, I <sub>e</sub> 1/h	300	300	-	-	-	
<b>Mechanical life</b>							
AC operated	S x 10 <sup>6</sup>	5	5	10	10	8	
DC operated	S x 10 <sup>6</sup>	5	5	10	10	8	
<b>Short time current</b>	10s-current A	680	880	1200	1400	1800	
<b>Power loss</b> per pole	at I <sub>e</sub> /AC3 400V W	4,3	6,0	8	11	8	
<b>Resistance to shock acc. to IEC 68-2-27</b>							
Shock time 20ms sine-wave	NO g	7	7	-	-	-	
	NC g	5	5	-	-	-	

\*1 Suitable at 690V for: earthed-neutral systems, overvoltage I to IV, pollution degree 3 (standard-industry): U<sub>imp</sub> = 8kV. Data for other conditions on request.  
\*2 Metal halide lamps and sodium-vapour lamps (high- and low-pressure lamps)  
\*3 High-pressure lamps  
\*4 Blended lamps, containing a mercury high-pressure unit and a tungsten helix in a fluorescent glass bulb (daylight lamps)  
\*5 Current inrush approx. 16 x I<sub>o</sub>  
\*6 With reduced control voltage range 0,9 up to 1,0 x U<sub>s</sub> and with reduced rated current I<sub>e</sub>/AC1 according to I<sub>e</sub>/AC3  
\*7 With reduced control voltage range 1,0 x U<sub>s</sub> and with reduced rated current I<sub>e</sub>/AC1 according to I<sub>e</sub>/AC3  
\*8 Maximum cable cross-section with prepared conductor

## Contactors

### Data according to IEC 947-4-1, EN 60947-4-1, VDE 0660

Auxiliary Contacts		Type	J7KN-10	J7KN-14	J7KN-18	J7KN-22	J7KN-24	J7KN-32	J7KN-40	J7KN-50	J7KN-62	J7KN-74
Rated insulation voltage U <sup>1</sup>		V~	690	690	690	690	-	-	-	-	-	-
Thermal rated current I <sub>n</sub> to 690V												
Ambient temperature		40°C A	16	16	16	16	-	-	-	-	-	-
		60°C A	12	12	12	12	-	-	-	-	-	-
<b>Utilization category AC15</b>												
Rated operational current I <sub>n</sub>		220-240V A	12	12	12	12	-	-	-	-	-	-
		380-415V A	4	4	4	4	-	-	-	-	-	-
		440V A	4	4	4	4	-	-	-	-	-	-
		500V A	3	3	3	3	-	-	-	-	-	-
		660-690V A	1	1	1	1	-	-	-	-	-	-
<b>Utilization category DC13</b>												
Rated operational current I <sub>n</sub>		60V A	8	8	8	8	-	-	-	-	-	-
		110V A	1	1	1	1	-	-	-	-	-	-
		220V A	0,1	0,1	0,1	0,1	-	-	-	-	-	-
<b>Short circuit protection</b>												
short-circuit current 1kA, contact welding not accepted												
max. fuse size		gL (gG) A	25	25	25	25	-	-	-	-	-	-
For contactors with thermal overload relay the device with the smaller admissible control fuse (contactor or thermal overload relay) determines the fuse.												
<b>Control Circuit</b>												
<b>Power consumption of coils</b>												
AC operated		inrush VA	33-45				90-115			140-165		
		sealed VA	7-10				9-13			13-18		
		W	2,6-3				2,7-4			5,4-7		
DC operated		inrush W	75				140			200		
		sealed W	2				2			6		
DC solenoid operated (J7KNG-types)		inrush W	3				4			-		
		sealed W	3				4			-		
<b>Operation range of coils</b>												
in multiples of control voltage U <sub>c</sub>		AC operated	0,85-1,1				0,85-1,1			0,85-1,1		
		DC operated	0,8-1,1				0,8-1,1			0,8-1,1		
<b>Switching time at control voltage U<sub>c</sub> ±10%<sup>2,3</sup></b>												
AC operated		make time ms	8-16				10-25			12-28		
		release time ms	5-13				8-15			8-15		
		arc duration ms	10-15				10-15			10-15		
DC operated		make time ms	8-12				10-20			12-23		
		release time ms	8-13				10-15			10-18		
		arc duration ms	10-15				10-15			10-15		
DC solenoid operated		make time ms	65-85				65-85			-		
		release time ms	20-30 <sup>4</sup>				20-30 <sup>4</sup>			-		
		arc duration ms	10-15				10-15			-		
<b>Cable cross-section</b>												
Auxiliary connector		solid mm <sup>2</sup>	0,75-6				-			-		
		flexible mm <sup>2</sup>	1-4				-			-		
flexible with multicore cable end		mm <sup>2</sup>	0,75-4				-			-		
Magnet coil		solid mm <sup>2</sup>	0,75-2,5				0,75-2,5			0,75-2,5		
		flexible mm <sup>2</sup>	0,5-2,5				0,5-2,5			0,5-2,5		
		flexible with multicore cable end mm <sup>2</sup>	0,5-1,5				0,5-1,5			0,5-1,5		
Clamps per pole			2				2			2		
Auxiliary connector		solid AWG	18 - 10				-			-		
		flexible AWG	18 - 10				-			-		
Magnet coil		solid AWG	14 - 12				14 - 12			14 - 12		
		flexible AWG	18 - 12				18 - 12			18 - 12		
Clamps per pole			2				2			2		

<sup>1</sup> Suitable for: earthed-neutral systems, overvoltage category I to IV, pollution degree 3 (standard-industry); U<sub>imp</sub> = 8kV. Data for other conditions on request

<sup>2</sup> Total breaking time = release time + arc duration

<sup>3</sup> Values for delay of the release time of the making contact and the make time of the break contact will be increased, if magnet coils are protected against voltage peaks (varistor, RC-unit, diode-unit)

<sup>4</sup> with integrated suppressor

Auxiliary Contacts		Type	J7KN-85	J7KN-110	J7KN-151	J7KN-176	J7KN-200
Rated insulation voltage $U_i$ <sup>1</sup>		V~	690	690	690	690	690
Thermal rated current $I_n$ to 690V							
Ambient temperature		40°C A	16	16	10	10	10
		60°C A	12	12	-	-	-
<b>Utilization category AC15</b>							
Rated operational current $I_n$		220-240V A	12	12	3	3	3
		380-415V A	6	6	2	2	2
		440V A	6	6	1,5	1,5	1,5
		500V A	4	4	1,5	1,5	1,5
		660-690V A	2	2	1	1	1
<b>Utilization category DC13</b>							
Rated operational current $I_n$		60V A	8	8	-	-	-
		110V A	1	1	0,5	0,5	1
		220V A	0,1	0,1	0,2	0,2	0,5
<b>Short circuit protection</b>							
short-circuit current 1kA, contact welding not accepted							
max. fuse size		gL (gG) A	25	25	10	10	10
For contactors with thermal overload relay the device with the smaller admissible control fuse (contactor or thermal overload relay) determines the fuse.							
<b>Control Circuit</b>							
<b>Power consumption of coils</b>							
AC operated		inrush VA	280-350	350-420	350	350	700
		sealed VA	16 -23	23 -29	5	5	20
		W	4-6	6-7,3	-	-	-
DC operated		inrush W	170	320	350	350	700
		sealed W	2	4	5	5	20
<b>Operation range of coils</b>							
in multiples of control voltage $U_c$		AC operated	0,85-1,1		0,85-1,1	0,85-1,1	0,85-1,1
		DC operated	0,8-1,1		0,85-1,1	0,85-1,1	0,85-1,1
<b>Switching time at control voltage <math>U_c \pm 10\%</math><sup>2,3</sup></b>							
AC operated		make time ms	13-30		30-60	30-60	40-60
		release time ms	8-15		30-80	30-80	15-45
		arc duration ms	10-15		-	-	-
DC operated		make time ms	20-30		-	-	-
		release time ms	10-18		-	-	-
		arc duration ms	10-15		-	-	-
<b>Cable cross-section</b>							
Auxiliary connector		solid mm <sup>2</sup>	0,75-2,5		-		0,75-2,5
		flexible mm <sup>2</sup>	0,75-2,5		-		0,75-2,5
flexible with multicore cable end		mm <sup>2</sup>	0,5-1,5		-		
Magnet coil		solid mm <sup>2</sup>	0,75-2,5		1-2,5		
		flexible mm <sup>2</sup>	0,5-2,5		1-2,5		
		flexible with multicore cable end mm <sup>2</sup>	0,5-1,5		-		
Clamps per pole			14 - 12		16 - 12		
Auxiliary connector		solid AWG	18 - 12		-		16 - 12
		flexible AWG	14 - 12		-		16 - 12
Magnet coil		solid AWG	18 - 12		16 - 12		
		flexible AWG	2		2		
Clamps per pole			0,75-2,5		0,75-2,5		

<sup>1</sup> Suitable for: earthed-neutral systems, overvoltage category I to IV, pollution degree 3 (standard-industry):  $U_{imp} = 8kV$ . Data for other conditions on request

<sup>2</sup> Total breaking time = release time + arc duration

<sup>3</sup> Values for delay of the release time of the making contact and the make time of the break contact will be increased, if magnet coils are protected against voltage peaks (varistor, RC-unit, diode-unit)

## Contactors for North America

### Data according to UL508

Main Contacts (cULus)	Type	J7KN-10	J7KN-14	J7KN-18	J7KN-22	J7KN-24	J7KN-32	J7KN-40	J7KN-50	J7KN-62	J7KN-74
Rated operational current "General Use"	A	25	25	30	30	50	65	80	110	120	130
Rated operational power of three-phase motors at 60Hz (3ph)	110-120V hp	1½	2	2	3	5	5	7½	10	10	10
	200V hp	3	3	5	5	7½	10	10	15	20	25
	220-240V hp	3	3	7½	7½	10	10	15	20	25	30
	277V hp	3	5	7½	7½	7½	10	15	20	25	30
	380-415V hp	5	5	10	10	10	15	20	25	30	40
	440-480V hp	5	7½	10	15	15	20	25	30	40	50
Rated operational power of AC motors at 60Hz (1ph)	550-600V hp	7½	10	15	20	20	25	30	40	50	50
	110-120V hp	½	¾	1	1½	1½	2	3	3	5	7½
	200V hp	1	1,5	2	3	3	5	7½	7½	10	15
	220-240V hp	1½	2	3	3	5	5	7½	10	15	15
	277V hp	2	3	3	5	5	7½	10	10	15	15
	380-415V hp	3	3	5	5	5	7½	10	15	20	20
Rated operational power of three-phase motors at 60Hz (3ph) for elevators	440-480V hp	3	5	5	7½	7½	10	15	20	25	25
	550-600V hp	3	5	7½	10	10	15	20	25	30	30
	110-120V hp	-	-	-	-	2	3	-	3	5	-
Demands according to ANSI A17.5 (500.000 operations)	200V hp	-	-	-	-	3	5	-	7½	10	-
	220-240V hp	-	-	-	-	5	7½	-	7½	10	-
Rated operational current Fuses	440-480V hp	-	-	-	-	10	15	-	20	25	-
	550-600V hp	-	-	-	-	10	20	-	25	30	-
Rated operational current Fuses	600V A	-	-	-	-	15	22	-	27	37	-
	A	30	40	50	50	90	125	175	175	225	250
Suitable for use on a capability of delivering not more than (SCCR)	rms A	5000	5000	5000	5000	5000	5000	5000	5000	5000	5000
	V	600	600	600	600	600	600	600	600	600	600
Auxiliary Contacts (cULus)		A600	A600	A600	A600	-	-	-	-	-	-

Main Contacts (cULus)	Type	J7KN-85	J7KN-110	J7KN-151	J7KN-176	J7KN-200
Rated operational current "General Use"	A	125	125	180	220	-
Rated operational power of three-phase motors at 60Hz (3ph)	110-120V hp	15	-	-	-	-
	200V hp	-	30	40	50	-
	220-240V hp	35	40	50	60	-
	277V hp	-	-	-	-	-
	380-415V hp	-	-	-	-	-
	440-480V hp	65	75	100	125	-
Rated operational power of AC motors at 60Hz (1ph)	550-600V hp	85	100	125	150	-
	110-120V hp	8	10	15	25	-
	200V hp	-	20	-	-	-
	220-240V hp	20	20	25	30	-
	277V hp	-	-	-	-	-
	380-415V hp	-	-	-	-	-
Rated operational power of three-phase motors at 60Hz (3ph) for elevators	440-480V hp	-	50	-	-	-
	550-600V hp	-	60	-	-	-
	110-120V hp	-	-	-	-	-
Demands according to ANSI A17.5 (500.000 operations)	200V hp	-	-	-	-	-
	220-240V hp	-	-	-	-	-
Rated operational current Fuses	440-480V hp	-	-	-	-	-
	550-600V hp	-	-	-	-	-
Rated operational current Fuses	600V A	-	62	-	-	-
	A	-	300	300	500	-
Suitable for use on a capability of delivering not more than (SCCR)	rms A	10000	10000	10000	10000	-
	V	600	600	600	600	-
Auxiliary Contacts (cULus)		A600	A600	-	-	-

# Contactors

## Data according to IEC 947-4-1, EN 60947-4-1, VDE 0660

### Contact Life

For selection of the suitable contactor-type according to supply voltage, power rating and application (utilization category AC1, AC3 or AC4) use contact life characteristic diagram.

For the most common supply voltages four scales of power ratings P<sub>n</sub> are provided for each utilization category.

Select contactor-type according to utilization category **AC3** (breaking current I<sub>a</sub> = I<sub>e</sub>) using the **motor rating** scales to the right, according to utilization category **AC4** (breaking current I<sub>a</sub> = 6 x I<sub>e</sub>) using the **motor rating** scales to the left.<sup>1</sup>

Select contactor-type according to utilization category **AC1** (breaking current I<sub>a</sub> = I<sub>e</sub>/AC1) using the **breaking current** scale.<sup>1</sup>

For contactors frequently used under AC3/AC4-mixed service conditions calculate contact life with the formula:

$$M = \frac{AC3}{1 + \frac{\%AC4}{100} \times \left( \frac{AC3}{AC4} - 1 \right)}$$

M = Contact life (switching cycles) for AC3/AC4-mixed operations

AC3 = Contact life (switching cycles) for AC3 operations (normal switching conditions). Breaking current I<sub>a</sub> = rated motor current I<sub>n</sub>.

AC4 = Contact life (switching cycles) for AC4 operations (inching).

Breaking current I<sub>a</sub> = multiples of rated motor current I<sub>n</sub>.

%AC4 = Percents of AC4-operations related to the total cycles.

1. Pay attention to the approved rated values of the selected contactor according to the national approvals

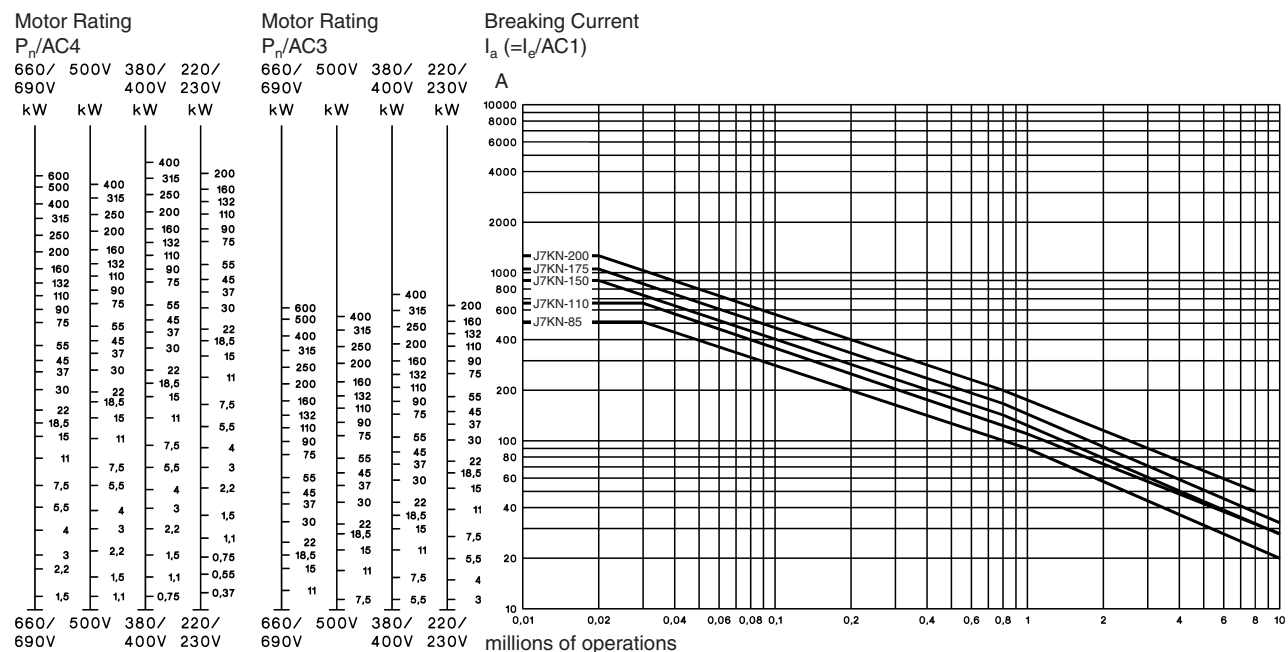
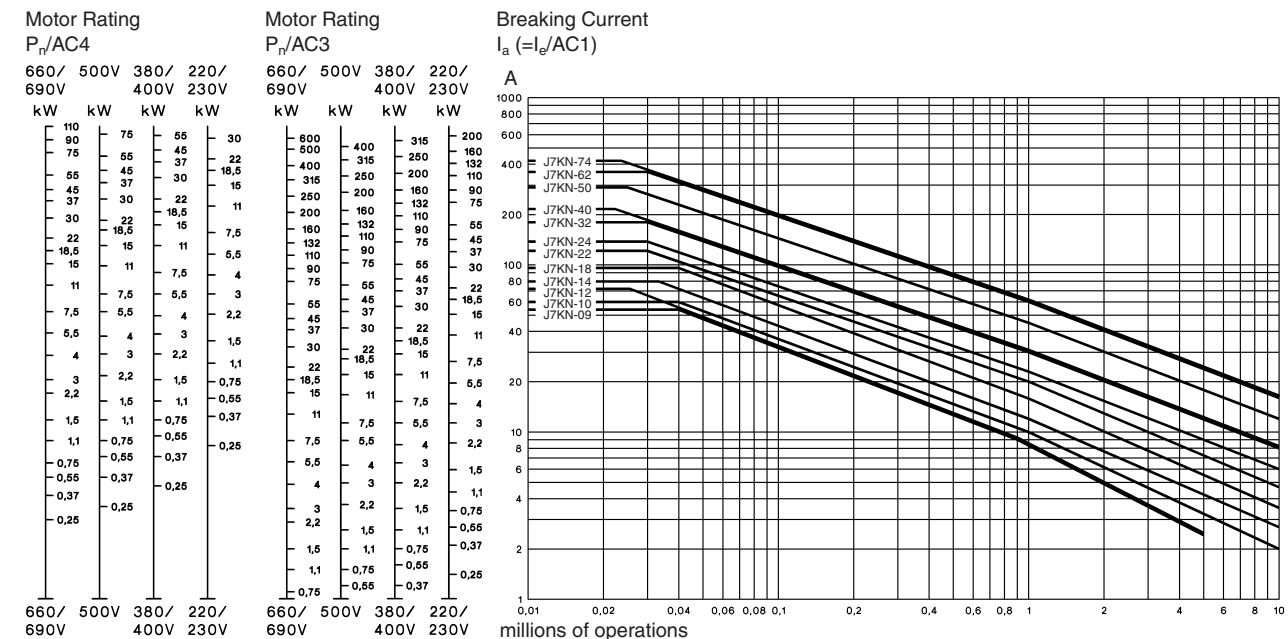



# Contactors

## Utilization Categories

For easier choice of devices and in order to make the comparison of different products simpler are utilization categories for contactors and motor-starters according to IEC 947-4-1 and VDE 0660 Part 102 ,for

control circuit devices and switching elements according to IEC 947-5-1 and VDE 0660 Part 200 determind. The table offers different utilization categories, typical applications and assorted test conditions.

Type of current	Category	Typical applications	Rated operational current	Test conditions for the number of on-load operating cycles						Test conditions for making and breaking capacities					
				Make I/le	U/Ue	cos	Break Ic/le	Ur/Ue	cos	Make I/le	U/Ue	cos	Break Ic/le	Ur/Ue	cos
Alternating Current	AC1	Non-inductive or slightly inductive loads-resistance furnaces	all values	1	1	0.95	1	1	0.95	1.5	1.05	0.8	1.5	1.05	0.8
	AC2	Slip-ring motors: starting, switching off	all values	2.5	1	0.65	2.5	1	0.65	4	1.05	0.65	4	1.05	0.65
	AC3	Squirrel-cage motors: starting, switching off motors during running	17A< le 17A	6	1	0.65	1	0.17	0.65	10	1.05	0.45	8	1.05	0.45
			le 100A	6	1	0.35	1	0.17	0.35	10	1.05	0.45	8	1.05	0.45
			le> 100A	6	1	0.35	1	0.17	0.35	10	1.05	0.35	8	1.05	0.35
	AC4	Squirrel-cage motors: starting, plugging, inching	17A< le 17A	6	1	0.65	6	1	0.65	12	1.05	0.45	10	1.05	0.45
			le 100A	6	1	0.35	6	1	0.35	12	1.05	0.45	10	1.05	0.45
			le> 100A	6	1	0.35	6	1	0.35	12	1.05	0.35	10	1.05	0.35
	AC5a	Switching of electric discharge lamp controls	all values	-	-	-	-	-	-	3	1.05	0.45	3	1.05	0.45
	AC5b	Switching of incandescent lamps	all values	-	-	-	-	-	-	1.5	1.05	1)	4	1.05	1)
	AC6a	Switching of transformers	le 100A	-	-	-	-	-	-	4.5	1.05	0.45	3.6	1.05	0.45
			le> 100A	-	-	-	-	-	-	4.5	1.05	0.35	3.6	1.05	0.35
	AC6b	Switching of capacitor banks	-	-	-	-	-	-	-	2)			2)		
	AC7a	Slightly inductive loads in household appliances and similar applications	all values	-	-	-	-	-	-	1.5	1.05	0.8	1.5	1.05	0.8
	AC7b	Motor loadsfor household applications	le 100A	-	-	-	-	-	-	8	1.05	0.45	6	1.05	0.45
le> 100A			-	-	-	-	-	-	8	1.05	0.35	6	1.05	0.35	
AC8a	Hermetic refrigerant compressor motor control with manualresetting of overload releases	le 100A	-	-	-	-	-	-	6	1.05	0.45	6	1.05	0.45	
		le> 100A	-	-	-	-	-	-	6	1.05	0.35	6	1.05	0.35	
AC8b	Hermetic refrigerant compressor motor control with automatic resetting of overload releases	le 100A	-	-	-	-	-	-	6	1.05	0.45	6	1.05	0.45	
		le> 100A	-	-	-	-	-	-	6	1.05	0.35	6	1.05	0.35	
AC12	Control of resistive loads and solid state loads with isolation by opto couplers	all values	-	-	-	-	-	-	1	1	0.9	1	1	0.9	
AC13	Control of solid state loads with transformer isolation	all values	-	-	-	-	-	-	10	1.1	0.65	1.1	1.1	0.65	
AC14	Control of small electromagnetic loads (<=72VA)	-	-	-	-	-	-	-	6	1.1	0.7	6	1.1	0.7	
AC15	Control of electromagnetic load (>72VA)	-	10	1	0.7	1	1	0.4	10	1.1	0.3	10	1.1	0.3	
				Make I/le	U/Ue	L/R [ms]	Break Ic/le	Ur/Ue	L/R [ms]	Make I/le	U/Ue	L/R [ms]	Break Ic/le	Ur/Ue	L/R [ms]
Direct Current	DC1	Non-inductive or slightly inductive loads resistance furnaces	all values	1	1	1	1	1	1	1.5	1.05	1	1.5	1.05	1
	DC3	Shunt-motors: starting, plugging, inching dynamic braking of d.c. motors	all values	2.5	1	2	2.5	1	2	4	1.05	2.5	4	1.05	2.5
	DC5	Series-motors: starting, plugging, inching dynamic braking of d.c. motors	all values	2.5	1	7.5	2.5	1	7.5	4	1.05	15	4	1.05	15
	DC6	Switching of incandescent lamps	all values	-	-	-	-	-	-	1.5	1.05	1)	4	1.05	1)
	DC12	Control of resistive loads and solid state loads with isolation by opto couplers	all values	-	-	-	-	-	-	1	1	1	1	1	1
	DC13	Control of electromagnets	all values	1	1	300	1	1	300	1.1	1.1	300	1.1	1.1	300
	DC14	Control of electromagnetic loads having economy resistors in circuit	all values	-	-	-	-	-	-	10	1.1	15	10	1.1	15

U, Rated operational voltage, U Voltage before make, U Recovery voltage, I, Rated operational current, I Current make, I Current broken

- 1) Test with incandescent lamps
- 2) Test conditions according to standard

## Accessories

### Data according to IEC 947-5-1, EN 60947-5-1, VDE 0660

Auxiliary Contacts	Type	J73KN-B	J73KN-C	J73KN-D	J74KN-B-TP...
Rated insulation voltage U <sup>*1</sup>	V~	690	690	690	690
Thermal rated current I <sub>n</sub> to 690V					
Ambient temperature	40°C A	10	10	10	10
	60°C A	6	6	-	-
Frequency of operations z	1/h	3000	3000	3000	1200
Mechanical life	S x 10 <sup>6</sup>	10	10	10	1
Power loss per pole at I <sub>n</sub> /AC1	W	0,5	0,5	-	-
Utilization category AC15					
Rated operational current I <sub>n</sub>	220-240V A	3	3	3	4
	380-400V A	2	2	2	3
	440V A	1,6	1,6	1,5	2
	500V A	1,2	1,2	1,5	2
	660-690V A	0,6	0,6	1	2
Utilization category DC13					
Rated operational current I <sub>n</sub>	60V A	2	2	-	2,5
	110V A	0,4	0,4	1	1,5
	220V A	0,1	0,1	0,5	0,2
Short circuit protection					
short-circuit current 1kA, contact welding not accepted max. fuse size	gL (gG) A	20	20	10	10
For contactors with thermal overload relay or auxiliary contacts the device with the smaller admissible control fuse (contactor or thermal overload relay) determines the fuse size.					
Cable cross-sections					
	solid or stranded mm <sup>2</sup>	0,75-2,5	0,75-2,5	0,75-2,5	1-2,5
	flexible mm <sup>2</sup>	0,75-2,5	0,75-2,5	0,75-2,5	0,75-2,5
	flexible with multicore cable end mm <sup>2</sup>	0,5-1,5	0,5-1,5	-	0,75-2,5
Cables per clamp		2	2	2	2

\*1 Suitable for: earthed-neutral systems, overvoltage category I to IV, pollution degree 3 (standard-industry): U<sub>imp</sub> = 8kV. Data for other conditions on request

### Data according to CSA, UL and CUL

Auxiliary Contacts	Type	J73KN-B	J73KN-C	J73KN-D	J74KN-B-TP...
Rated operational current „General Use“	A	10	10	10	10
Rated operational voltage	max. V AC	600	600	600	600
Auxiliary Contacts		A600	A600	A600	A600

## Contactors and Accessories

### Wiring diagrams

#### Auxiliary contact blocks

J73KN-B-10

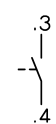

J73KN-B-01

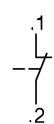

J73KN-C-11S<sup>\*1</sup>

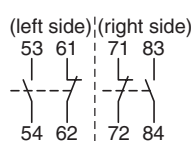

#### Pneumatic timer

on-delayed

J74KN-B-TP...DA

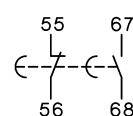

off-delayed

J74KN-B-TP...IA

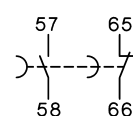

J73KN-D-11

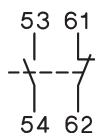

J73KN-D-11S

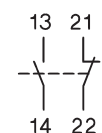

J73KN-D-22

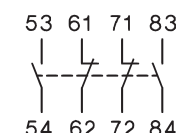

\*1 Correct terminal marking is given by mounting

# Dimensions

AC operated

J7KN-10/14/18/22(-4)...

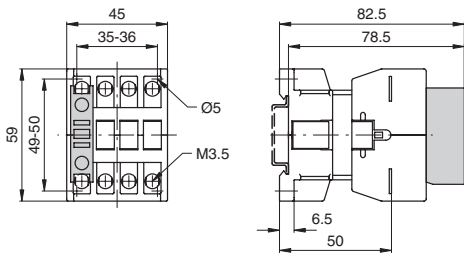

J7KN-24/32/40...

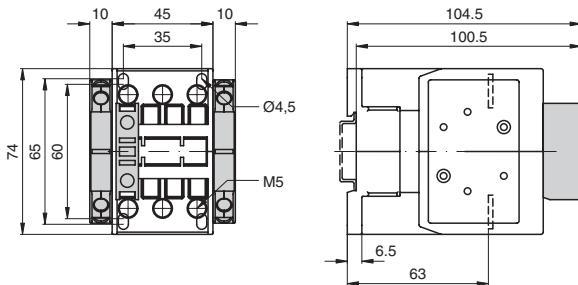

J7KN-50/62/74...

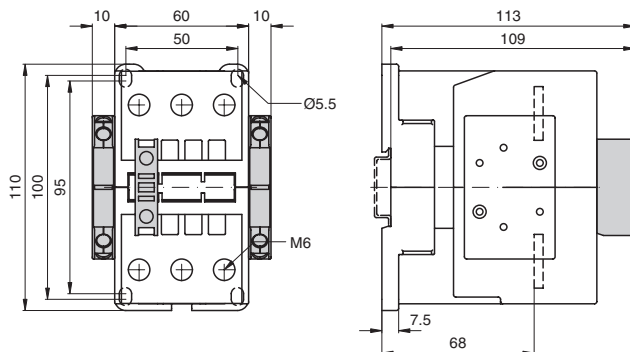

■ Auxiliary contacts are optional

DC operated

J7KN-10/14/18/22...D

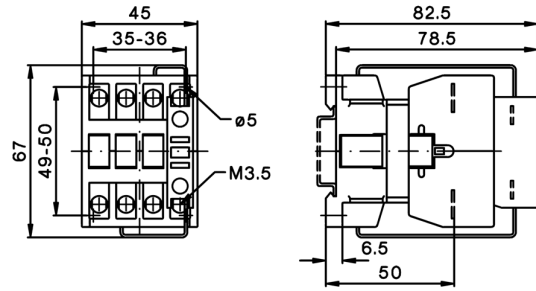

J7KNG-10/14/18/22(-4)...D

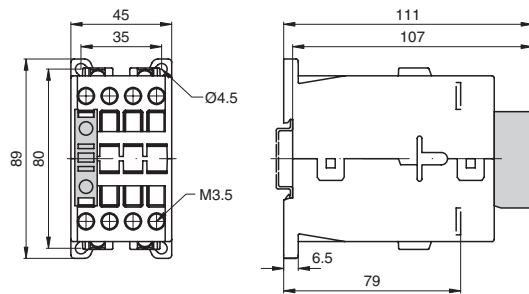

J7KN-24/32/40...D

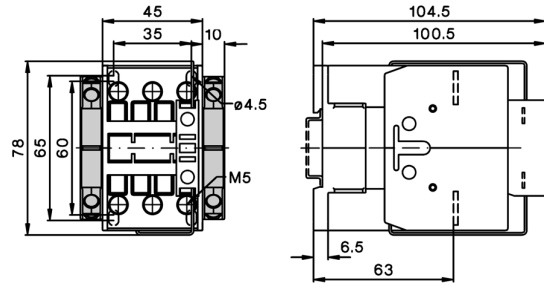

J7KNG-24/32/40...D

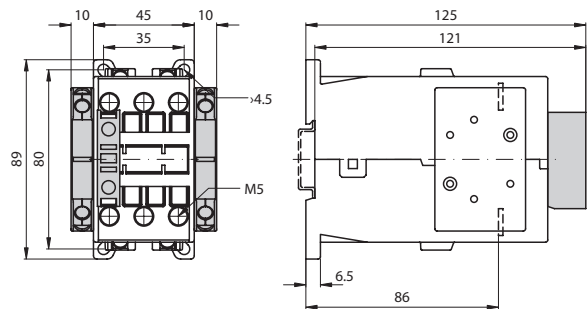

J7KN-50/62/74...D

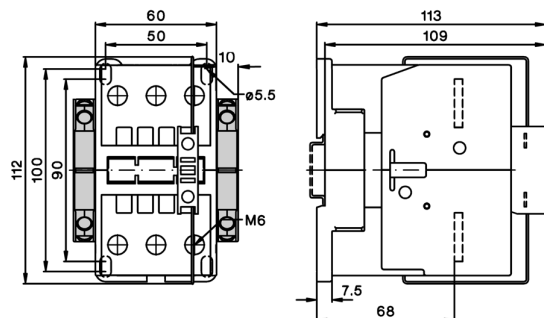

AC and DC operated

J7KN-85...  
J7KN-110...

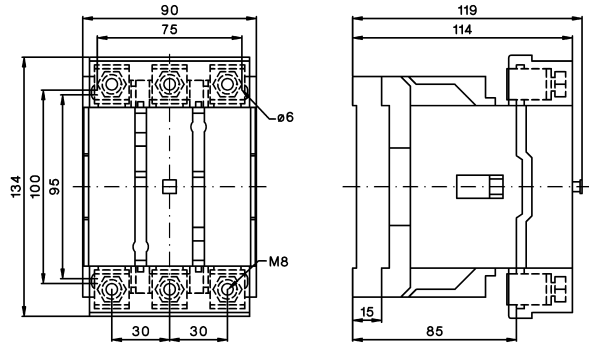

J7KN-151...  
J7KN-176...

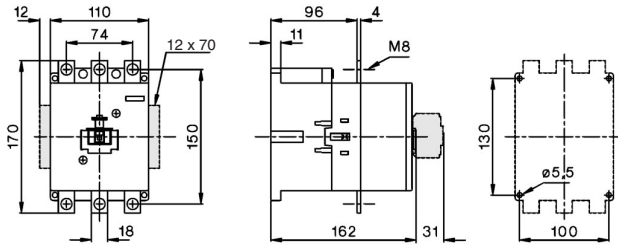

Auxiliary contacts are optional

J7KN-200...

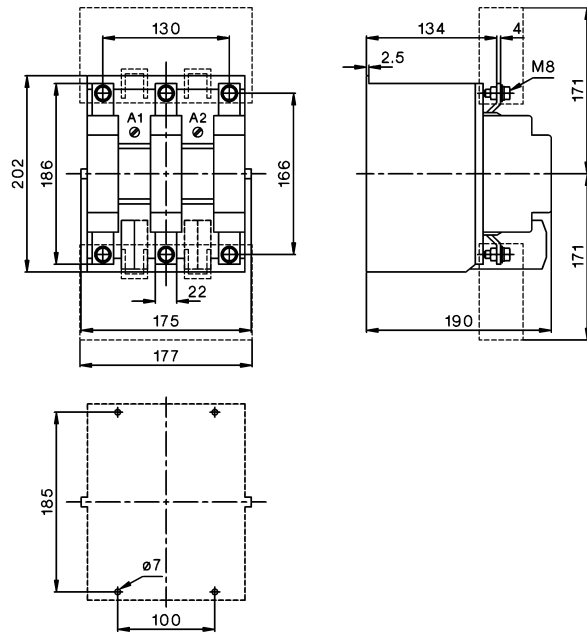

Pneumatic timer

J74KN-B-TP...

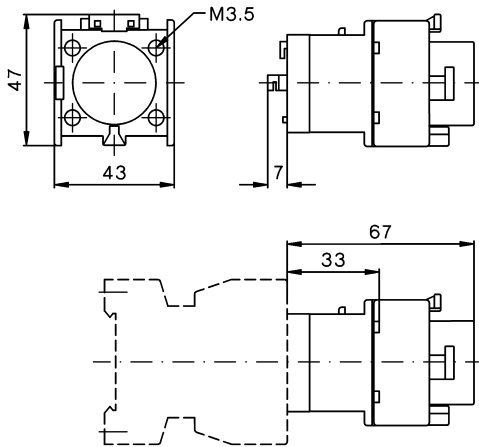

Auxiliary contact blocks

J74KN-A-VG

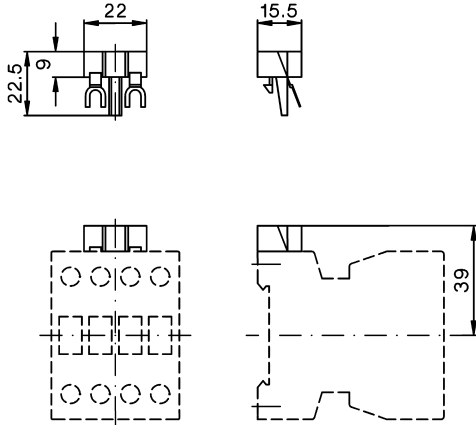

J74KN-B-VG

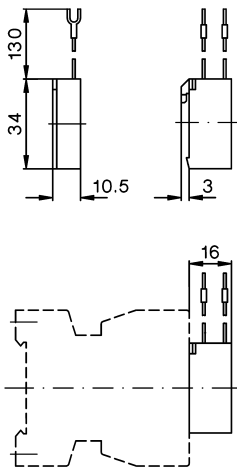

J74KN-C

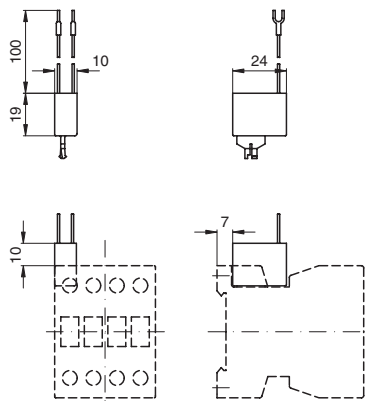

J74KN-D

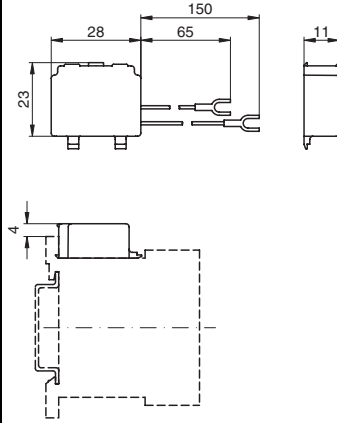

J74KN-B-RC

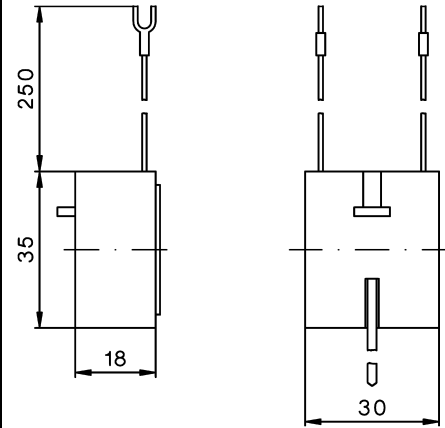

Position of Terminals

AC operated

J7KN-10-10  
to  
J7KN-22-10

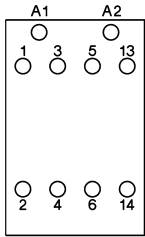

J7KN-10-01  
to  
J7KN-22-01



(A3)

J7KN-24  
J7KN-32  
J7KN-40

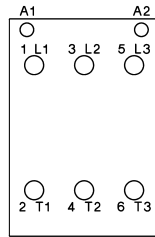

J7KN-50  
J7KN-62  
J7KN-74

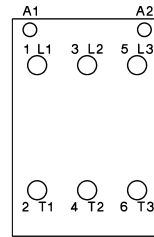

J7KN-85-22  
J7KN-110-22

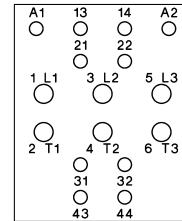

DC operated with double winding coil

J7KN-10-10...D  
J7KN-14-10...D  
J7KN-18-10...D  
J7KN-22-10...D

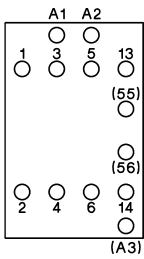

(A3)

J7KN-10-01...D  
J7KN-14-01...D  
J7KN-18-01...D  
J7KN-22-01...D

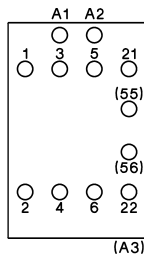

(A3)

J7KN-24...D  
J7KN-32...D  
J7KN-40...D

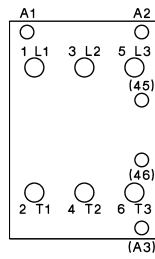

(A3)

J7KN-50...D  
J7KN-62...D  
J7KN-74...D

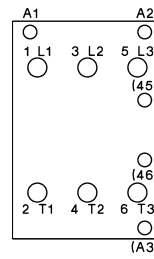

(A3)

J7KN-85-21...D  
J7KN-110-21...D

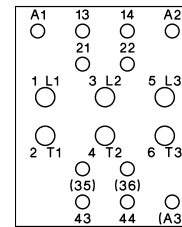

(A3)

AC and DC operated

J7KN-151  
J7KN-176

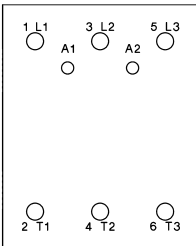

J7KN-200-21

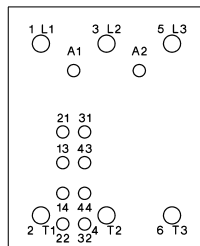

DC operated

J7KNG-10-10  
J7KNG-14-10  
J7KNG-18-10  
J7KNG-22-10

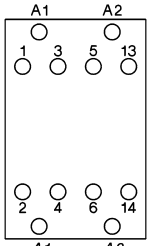

J7KNG-10-01  
J7KNG-14-01  
J7KNG-18-01  
J7KNG-22-01

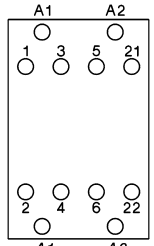

J7KNG-24  
J7KNG-32  
J7KNG-40

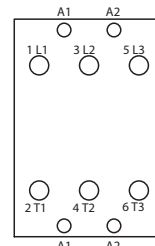

Do not use/install these products before having read the applicable precautions as listed in Cat. No. J09-EN-01 available from [www.europe.omron.com](http://www.europe.omron.com) or on request from OMRON local sales office.

# Terms and Conditions of Sale

1. **Offer; Acceptance.** These terms and conditions (these "Terms") are deemed part of all quotes, agreements, purchase orders, acknowledgments, price lists, catalogs, manuals, brochures and other documents, whether electronic or in writing, relating to the sale of products or services (collectively, the "Products") by Omron Electronics LLC and its subsidiary companies ("Omron"). Omron objects to any terms or conditions proposed in Buyer's purchase order or other documents which are inconsistent with, or in addition to, these Terms.
2. **Prices; Payment Terms.** All prices stated are current, subject to change without notice by Omron. Omron reserves the right to increase or decrease prices on any unshipped portions of outstanding orders. Payments for Products are due net 30 days unless otherwise stated in the invoice.
3. **Discounts.** Cash discounts, if any, will apply only on the net amount of invoices sent to Buyer after deducting transportation charges, taxes and duties, and will be allowed only if (i) the invoice is paid according to Omron's payment terms and (ii) Buyer has no past due amounts.
4. **Interest.** Omron, at its option, may charge Buyer 1-1/2% interest per month or the maximum legal rate, whichever is less, on any balance not paid within the stated terms.
5. **Orders.** Omron will accept no order less than \$200 net billing.
6. **Governmental Approvals.** Buyer shall be responsible for, and shall bear all costs involved in, obtaining any government approvals required for the importation or sale of the Products.
7. **Taxes.** All taxes, duties and other governmental charges (other than general real property and income taxes), including any interest or penalties thereon, imposed directly or indirectly on Omron or required to be collected directly or indirectly by Omron for the manufacture, production, sale, delivery, importation, consumption or use of the Products sold hereunder (including customs duties and sales, excise, use, turnover and license taxes) shall be charged to and remitted by Buyer to Omron.
8. **Financial.** If the financial position of Buyer at any time becomes unsatisfactory to Omron, Omron reserves the right to stop shipments or require satisfactory security or payment in advance. If Buyer fails to make payment or otherwise comply with these Terms or any related agreement, Omron may (without liability and in addition to other remedies) cancel any unshipped portion of Products sold hereunder and stop any Products in transit until Buyer pays all amounts, including amounts payable hereunder, whether or not then due, which are owing to it by Buyer. Buyer shall in any event remain liable for all unpaid accounts.
9. **Cancellation; Etc.** Orders are not subject to rescheduling or cancellation unless Buyer indemnifies Omron against all related costs or expenses.
10. **Force Majeure.** Omron shall not be liable for any delay or failure in delivery resulting from causes beyond its control, including earthquakes, fires, floods, strikes or other labor disputes, shortage of labor or materials, accidents to machinery, acts of sabotage, riots, delay in or lack of transportation or the requirements of any government authority.
11. **Shipping; Delivery.** Unless otherwise expressly agreed in writing by Omron:
  - a. Shipments shall be by a carrier selected by Omron; Omron will not drop ship except in "break down" situations.
  - b. Such carrier shall act as the agent of Buyer and delivery to such carrier shall constitute delivery to Buyer;
  - c. All sales and shipments of Products shall be FOB shipping point (unless otherwise stated in writing by Omron), at which point title and risk of loss shall pass from Omron to Buyer; provided that Omron shall retain a security interest in the Products until the full purchase price is paid;
  - d. Delivery and shipping dates are estimates only; and
  - e. Omron will package Products as it deems proper for protection against normal handling and extra charges apply to special conditions.
12. **Claims.** Any claim by Buyer against Omron for shortage or damage to the Products occurring before delivery to the carrier must be presented in writing to Omron within 30 days of receipt of shipment and include the original transportation bill signed by the carrier noting that the carrier received the Products from Omron in the condition claimed.
13. **Warranties.** (a) **Exclusive Warranty.** Omron's exclusive warranty is that the Products will be free from defects in materials and workmanship for a period of twelve months from the date of sale by Omron (or such other period expressed in writing by Omron). Omron disclaims all other warranties, express or implied. (b) **Limitations.** OMRON MAKES NO WARRANTY OR REPRESENTATION, EXPRESS OR IMPLIED, ABOUT NON-INFRINGEMENT, MERCHANTABILITY OR FITNESS FOR A PARTICULAR PURPOSE OF THE PRODUCTS. BUYER ACKNOWLEDGES THAT IT ALONE HAS DETERMINED THAT THE PRODUCTS WILL SUITABLY MEET THE REQUIREMENTS OF THEIR INTENDED USE. Omron further disclaims all warranties and responsibility of any type for claims or expenses based on infringement by the Products or otherwise of any intellectual property right. (c) **Buyer Remedy.** Omron's sole obligation hereunder shall be, at Omron's election, to (i) replace (in the form originally shipped with Buyer responsible for labor charges for removal or replacement thereof) the non-complying Product, (ii) repair the non-complying Product, or (iii) repay or credit Buyer an amount equal to the purchase price of the non-complying Product; provided that in no event shall Omron be responsible for warranty, repair, indemnity or any other claims or expenses regarding the Products unless Omron's analysis confirms that the Products were properly handled, stored, installed and maintained and not subject to contamination, abuse, misuse or inappropriate modification. Return of any Products by Buyer must be approved in writing by Omron before shipment. Omron Companies shall not be liable for the suitability or unsuitability or the results from the use of Products in combination with any electrical or electronic components, circuits, system assemblies or any other materials or substances or environments. Any advice, recommendations or information given orally or in writing, are not to be construed as an amendment or addition to the above warranty. See <http://www.omron247.com> or contact your Omron representative for published information.
14. **Limitation on Liability; Etc.** OMRON COMPANIES SHALL NOT BE LIABLE FOR SPECIAL, INDIRECT, INCIDENTAL, OR CONSEQUENTIAL DAMAGES, LOSS OF PROFITS OR PRODUCTION OR COMMERCIAL LOSS IN ANY WAY CONNECTED WITH THE PRODUCTS, WHETHER SUCH CLAIM IS BASED IN CONTRACT, WARRANTY, NEGLIGENCE OR STRICT LIABILITY. Further, in no event shall liability of Omron Companies exceed the individual price of the Product on which liability is asserted.
15. **Indemnities.** Buyer shall indemnify and hold harmless Omron Companies and their employees from and against all liabilities, losses, claims, costs and expenses (including attorney's fees and expenses) related to any claim, investigation, litigation or proceeding (whether or not Omron is a party) which arises or is alleged to arise from Buyer's acts or omissions under these Terms or in any way with respect to the Products. Without limiting the foregoing, Buyer (at its own expense) shall indemnify and hold harmless Omron and defend or settle any action brought against such Companies to the extent based on a claim that any Product made to Buyer specifications infringed intellectual property rights of another party.
16. **Property; Confidentiality.** Any intellectual property in the Products is the exclusive property of Omron Companies and Buyer shall not attempt to duplicate it in any way without the written permission of Omron. Notwithstanding any charges to Buyer for engineering or tooling, all engineering and tooling shall remain the exclusive property of Omron. All information and materials supplied by Omron to Buyer relating to the Products are confidential and proprietary, and Buyer shall limit distribution thereof to its trusted employees and strictly prevent disclosure to any third party.
17. **Export Controls.** Buyer shall comply with all applicable laws, regulations and licenses regarding (i) export of products or information; (ii) sale of products to "forbidden" or other proscribed persons; and (iii) disclosure to non-citizens of regulated technology or information.
18. **Miscellaneous.** (a) **Waiver.** No failure or delay by Omron in exercising any right and no course of dealing between Buyer and Omron shall operate as a waiver of rights by Omron. (b) **Assignment.** Buyer may not assign its rights hereunder without Omron's written consent. (c) **Law.** These Terms are governed by the law of the jurisdiction of the home office of the Omron company from which Buyer is purchasing the Products (without regard to conflict of law principles). (d) **Amendment.** These Terms constitute the entire agreement between Buyer and Omron relating to the Products, and no provision may be changed or waived unless in writing signed by the parties. (e) **Severability.** If any provision hereof is rendered ineffective or invalid, such provision shall not invalidate any other provision. (f) **Setoff.** Buyer shall have no right to set off any amounts against the amount owing in respect of this invoice. (g) **Definitions.** As used herein, "including" means "including without limitation"; and "Omron Companies" (or similar words) mean Omron Corporation and any direct or indirect subsidiary or affiliate thereof.

## Certain Precautions on Specifications and Use

1. **Suitability of Use.** Omron Companies shall not be responsible for conformity with any standards, codes or regulations which apply to the combination of the Product in the Buyer's application or use of the Product. At Buyer's request, Omron will provide applicable third party certification documents identifying ratings and limitations of use which apply to the Product. This information by itself is not sufficient for a complete determination of the suitability of the Product in combination with the end product, machine, system, or other application or use. Buyer shall be solely responsible for determining appropriateness of the particular Product with respect to Buyer's application, product or system. Buyer shall take application responsibility in all cases but the following is a non-exhaustive list of applications for which particular attention must be given:
  - (i) Outdoor use, uses involving potential chemical contamination or electrical interference, or conditions or uses not described in this document.
  - (ii) Use in consumer products or any use in significant quantities.
  - (iii) Energy control systems, combustion systems, railroad systems, aviation systems, medical equipment, amusement machines, vehicles, safety equipment, and installations subject to separate industry or government regulations.
  - (iv) Systems, machines and equipment that could present a risk to life or property. Please know and observe all prohibitions of use applicable to this Product.
 NEVER USE THE PRODUCT FOR AN APPLICATION INVOLVING SERIOUS RISK TO LIFE OR PROPERTY OR IN LARGE QUANTITIES WITHOUT ENSURING THAT THE SYSTEM AS A WHOLE HAS BEEN DESIGNED TO ADDRESS THE RISKS, AND THAT THE OMRON'S PRODUCT IS PROPERLY RATED AND INSTALLED FOR THE INTENDED USE WITHIN THE OVERALL EQUIPMENT OR SYSTEM.
2. **Programmable Products.** Omron Companies shall not be responsible for the user's programming of a programmable Product, or any consequence thereof.
3. **Performance Data.** Data presented in Omron Company websites, catalogs and other materials is provided as a guide for the user in determining suitability and does not constitute a warranty. It may represent the result of Omron's test conditions, and the user must correlate it to actual application requirements. Actual performance is subject to the Omron's Warranty and Limitations of Liability.
4. **Change in Specifications.** Product specifications and accessories may be changed at any time based on improvements and other reasons. It is our practice to change part numbers when published ratings or features are changed, or when significant construction changes are made. However, some specifications of the Product may be changed without any notice. When in doubt, special part numbers may be assigned to fix or establish key specifications for your application. Please consult with your Omron's representative at any time to confirm actual specifications of purchased Product.
5. **Errors and Omissions.** Information presented by Omron Companies has been checked and is believed to be accurate; however, no responsibility is assumed for clerical, typographical or proofreading errors or omissions.

---

**Note:** This datasheet is provided as a guideline for selecting products. Do not use this document to operate the Unit.

**ALL DIMENSIONS SHOWN ARE IN MILLIMETERS.**

To convert millimeters into inches, multiply by 0.03937. To convert grams into ounces, multiply by 0.03527.

# OMRON

**OMRON ELECTRONICS LLC • THE AMERICAS HEADQUARTERS**

Schaumburg, IL USA • 847.843.7900 • 800.556.6766 • [www.omron247.com](http://www.omron247.com)

**OMRON CANADA, INC. • HEAD OFFICE**

Toronto, ON, Canada • 416.286.6465 • 866.986.6766 • [www.omron247.com](http://www.omron247.com)

**OMRON ELETRÔNICA DO BRASIL LTDA • HEAD OFFICE**

São Paulo, SP, Brasil • 55.11.2101.6300 • [www.omron.com.br](http://www.omron.com.br)

**OMRON ELECTRONICS MEXICO SA DE CV • HEAD OFFICE**

Apodaca, N.L. • 52.811.156.99.10 • 001.800.556.6766 • [mela@omron.com](mailto:mela@omron.com)

**OMRON ARGENTINA • SALES OFFICE**

Cono Sur • 54.11.4783.5300

**OMRON CHILE • SALES OFFICE**

Santiago • 56.9.9917.3920

**OTHER OMRON LATIN AMERICA SALES**

54.11.4783.5300

© 2009 Omron Electronics LLC

Cat. No. J06E-EN-01A

Specifications are subject to change without notice.