

A Unit of Teledyne Electronics and Communications

ULTRAMINIATURE BROADBAND ATTENUATOR RELAYS

SERIES A150

SERIES DESIGNATION	RELAY TYPE
A150	Attenuator Relay series

INTERNAL CONSTRUCTION

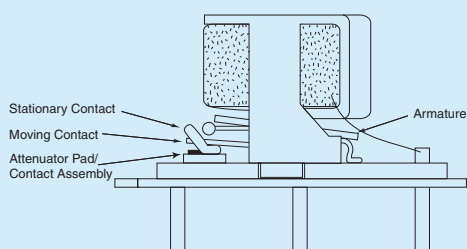

DESCRIPTION

The Series A150 ultraminiature Attenuator Relays are designed for attenuating RF signals in 50-ohm systems over a frequency range from DC to 3 GHz. Their low profile and small grid spacing makes them ideal for use when packaging density is a prime consideration. The A150 relays eliminate the need for additional external resistors.

These single section, switchable attenuator relays have internal matched thin film attenuator pads in "L," "T" or "Pi" configurations, as applicable. Relays are available in fixed increments of 1, 2, 3, 4, 5, 6, 8, 10, 16 and 20 dB, which can be used singly or in combination to achieve the attenuation levels desired.

The A150 attenuator relay features:

- Unique uni-frame motor design which provides high magnetic efficiency and mechanical rigidity.
- Minimum mass components and welded construction for maximum resistance to shock and vibration.
- Advanced cleaning techniques which assures internal cleanliness.
- Gold plated, precious metal contacts, which provide excellent intermodulation performance.
- Flat amplitude vs. frequency response.
- High isolation between control and signal path.
- Stable attenuation vs. temperature.
- Excellent phase linearity.
- Highly resistant to ESD.

SCHEMATIC DIAGRAM

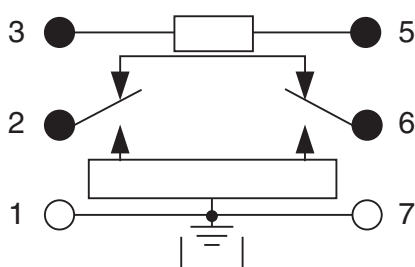

Terminal view. Case ground.

ENVIRONMENTAL AND PHYSICAL SPECIFICATIONS

Temperature (Ambient)	Storage	-65°C to +125°C
	Operating	-55°C to +85°C
Vibration (General Note 1)		10 g's to 500 Hz
Shock (General Note 1)		30 g's, 6 msec, half-sine
Enclosure		Hermetically sealed
Weight		0.11 oz. (3.12g) max.

Patent No. 5,315,273

SERIES A150
TYPICAL RF PERFORMANCE (Notes 2, 3 and 4)

1 dB ATTENUATOR

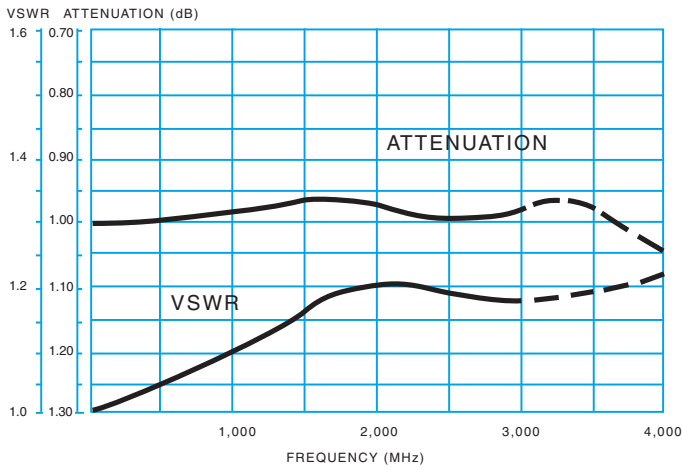

2 dB ATTENUATOR

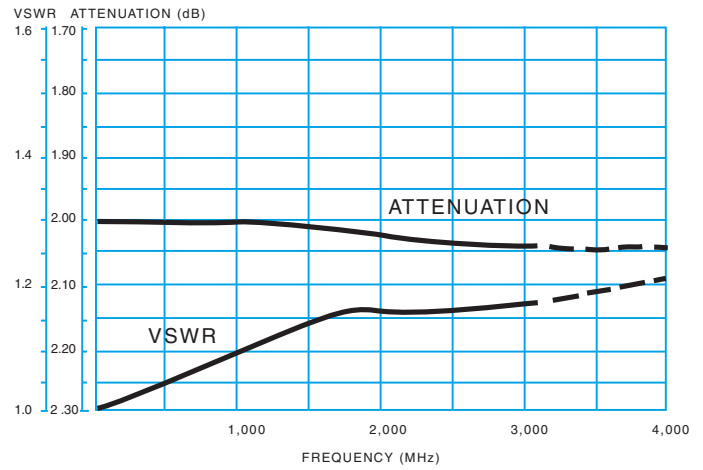

3 dB ATTENUATOR

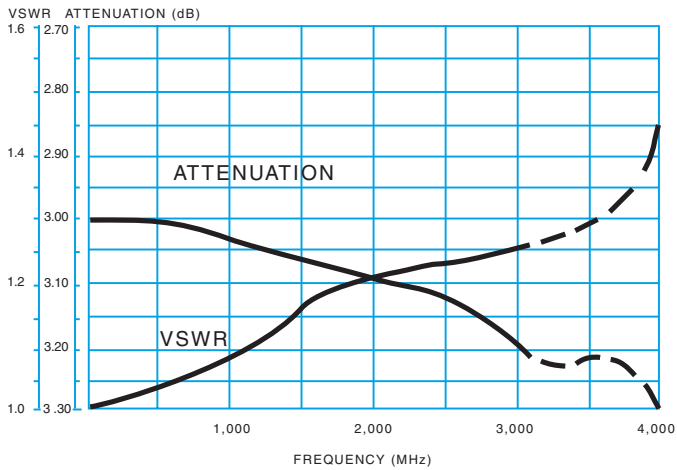

4 dB ATTENUATOR

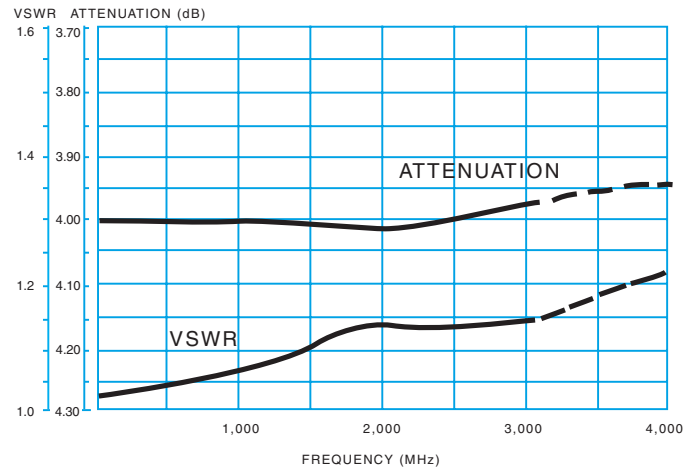

5 dB ATTENUATOR

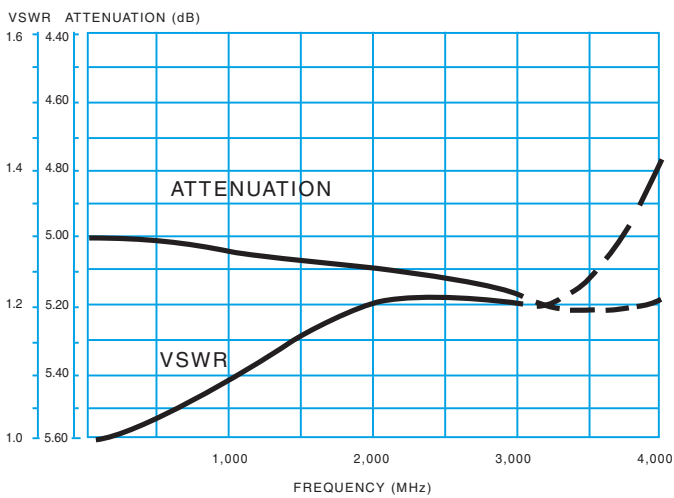

6 dB ATTENUATOR

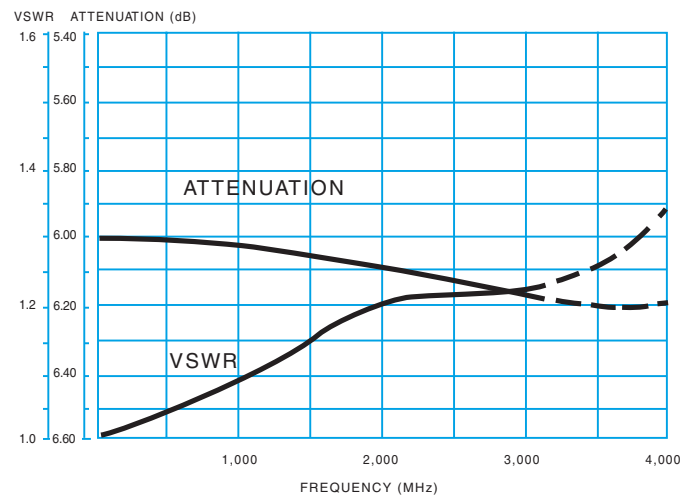

SERIES A150
TYPICAL RF PERFORMANCE (Notes 2, 3 and 4)

8 dB ATTENUATOR

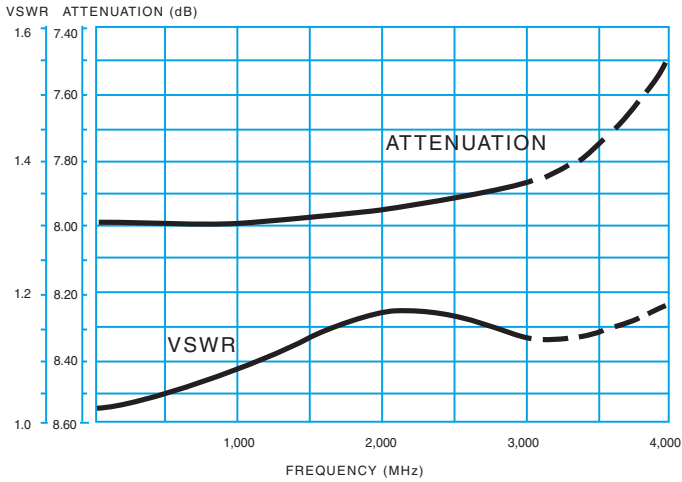

10 dB ATTENUATOR

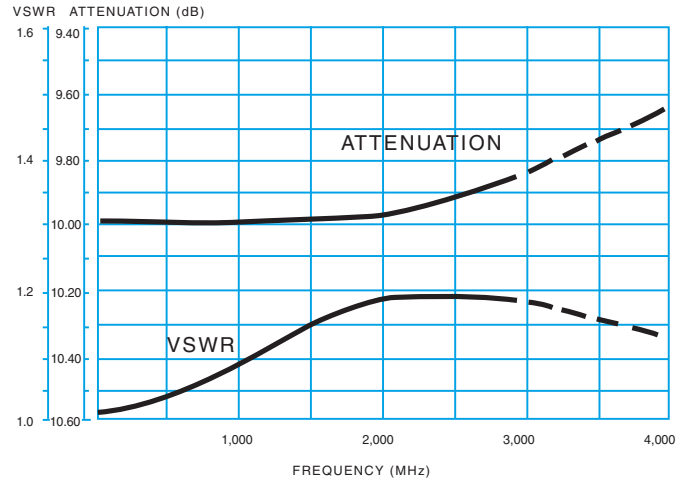

16 dB ATTENUATOR

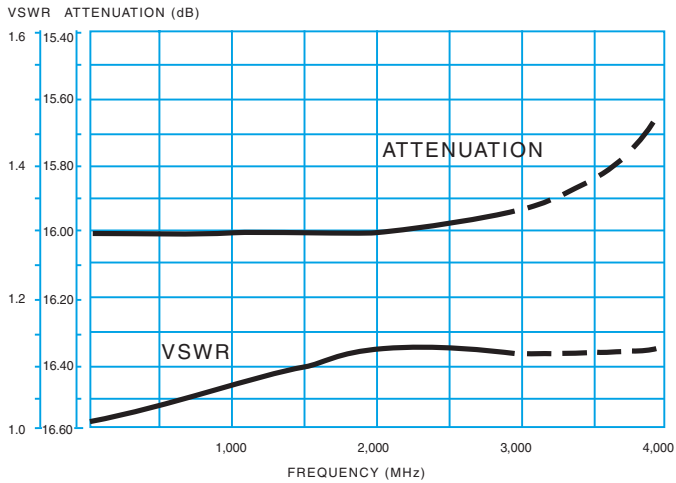

20 dB ATTENUATOR

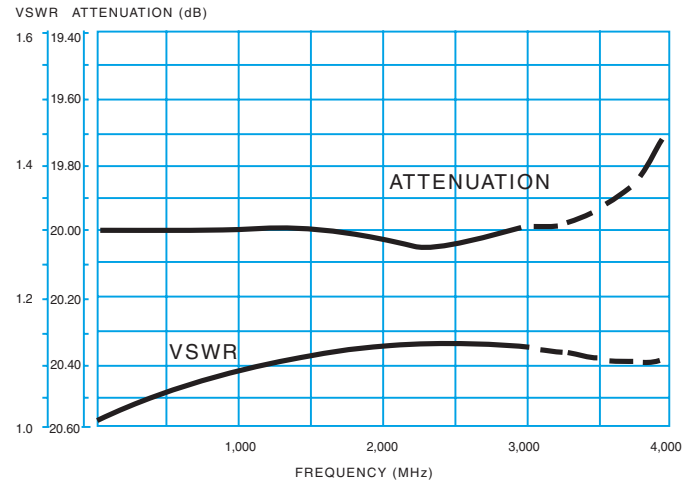

THROUGH PATH

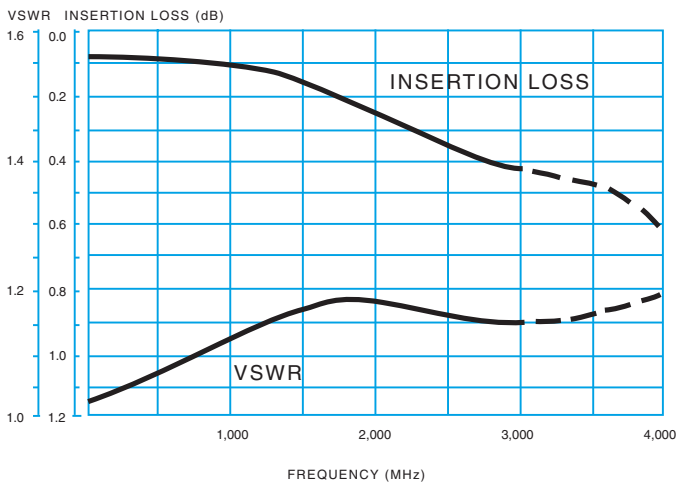

SERIES A150

RF PERFORMANCE (–55°C to +85°C) (Notes 2, 3 and 4)

PARAMETER	MINIMUM	TYPICAL	MAXIMUM	UNITS	CONDITION
Insertion Loss		0.1	0.25	dB	DC–1 GHz
		0.2	0.35	dB	1–2 GHz
		0.3	.055	dB	2–3 GHz
VSWR (Through path)		1.10	1.20		DC–1 GHz
		1.20	1.25		1–2 GHz
		1.25	1.30		2–3 GHz
VSWR (Attenuated path)		1.20	1.25		DC–1 GHz
		1.30	1.35		1–2 GHz
		1.40	1.45		2–3 GHz

ATTENUATION	MINIMUM	TYPICAL	MAXIMUM	UNITS	CONDITION
1	0.95	1.0	1.05	dB	DC–1 GHz
	0.925	1.0	1.075	dB	1–2 GHz
	0.875	1.0	1.125	dB	2–3 GHz
2	1.9	2.0	2.1	dB	DC–1 GHz
	1.85	2.0	2.15	dB	1–2 GHz
	1.75	2.0	2.25	dB	2–3 GHz
3	2.85	3.0	3.15	dB	DC–1 GHz
	2.77	3.0	3.23	dB	1–2 GHz
	2.62	3.0	3.38	dB	2–3 GHz
4	3.8	4.0	4.2	dB	DC–1 GHz
	3.7	4.0	4.3	dB	1–2 GHz
	3.5	4.0	4.5	dB	2–3 GHz
5	4.75	5.0	5.25	dB	DC–1 GHz
	4.62	5.0	5.38	dB	1–2 GHz
	4.37	5.0	5.63	dB	2–3 GHz
6	5.7	6.0	6.3	dB	DC–1 GHz
	5.55	6.0	6.45	dB	1–2 GHz
	5.25	6.0	6.75	dB	2–3 GHz
8	7.88	8.0	8.12	dB	DC–1 GHz
	7.76	8.0	8.24	dB	1–2 GHz
	7.52	8.0	8.48	dB	2–3 GHz
10	9.85	10.0	10.15	dB	DC–1 GHz
	9.7	10.0	10.3	dB	1–2 GHz
	9.4	10.0	10.6	dB	2–3 GHz
16	15.76	16.0	16.24	dB	DC–1 GHz
	15.52	16.0	16.48	dB	1–2 GHz
	15.04	16.0	16.96	dB	2–3 GHz
20	19.8	20.0	20.2	dB	DC–1 GHz
	19.6	20.0	20.4	dB	1–2 GHz
	19.0	20.0	21.0	dB	2–3 GHz

SERIES A150
GENERAL PERFORMANCE (–55°C TO +85°C)

PARAMETER	MINIMUM	TYPICAL	MAXIMUM	UNITS
Operating Frequency (Note 2)	0.0		3.0	GHz
Power (Notes 5 and 6)			1.0	Watt
Impedance		50		Ohms

PARAMETER	Typical at low level
Contact life rating	10,000,000 cycles

ELECTRICAL SPECIFICATION (–55°C TO +85°C, unless otherwise specified)

PART NUMBER (Note 7)	A150-dB-5	A150-dB-12	A150-dB-15	A150-dB-26	
Coil Voltage Vdc (Note 6)	Nom.	5	12	15	26.5
	Max.	5.8	16.0	20.0	32.0
Coil Resistance Ohms $\pm 20\%$	@25°C	50	390	610	1,560
Pick-up Voltage Vdc Max.	@25°C	3.8	9.0	11.3	18.0
Switching Time ms (Note 8)	Max.	4.0			
	Typ.	2.0			
Insulation Resistance	1,000 M Ω typical (all mutually isolated points)				
Dielectric strength	300 VRMS / 60 Hz typical (at sea level)				

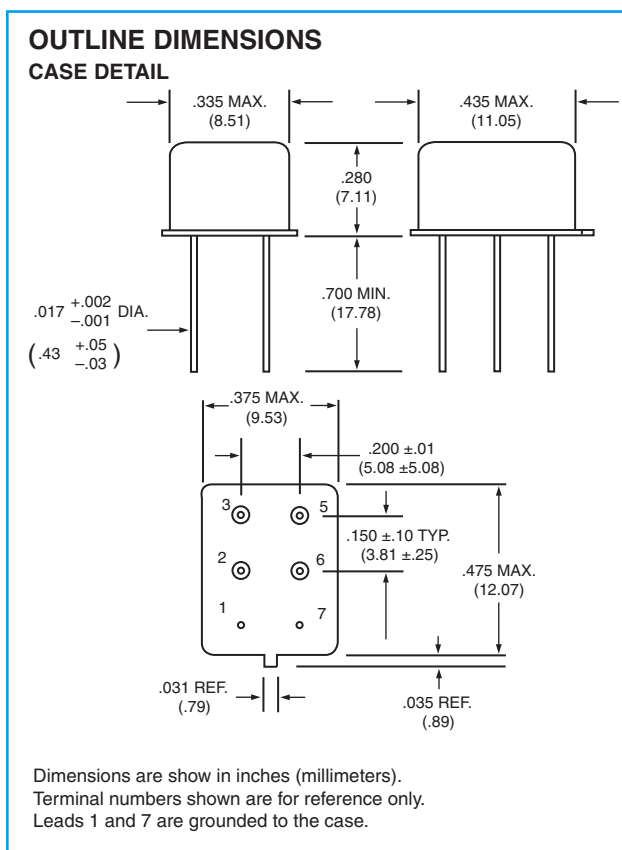
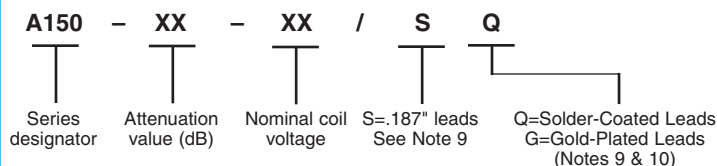
TELEDYNE RELAYS PART NUMBERING SYSTEM FOR A150 ATTENUATOR RELAYS

GENERAL NOTES:

- Contacts will exhibit no contact chatter in excess of 10 μ s or transfer in excess of 1 μ s.
- Relays may be operated at higher frequencies with reduced RF performance.
- For optimal RF performance, solder case to RF ground plane.
- Attenuation values shown are with reference to the through path (low loss state).
- Power handling for case temperatures of –55°C to +55°C is 1 Watt. Derate power handling 25 mW/°C above +55°C. Case measurement point is adjacent to the relay tab.
- Do not operate coil at maximum coil voltage continuously.
- Insert attenuation value, see part numbering system.
- Switching time includes bounce.
- The slash and characters appearing after the slash are not marked on the relay.
- Unless otherwise specified, relays will be supplied with either gold-plated or solder-coated leads.

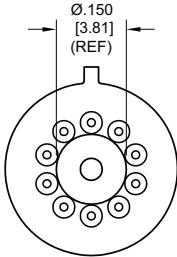
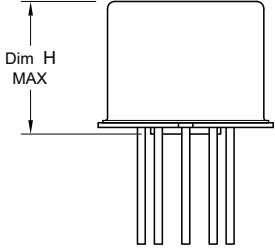
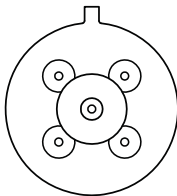
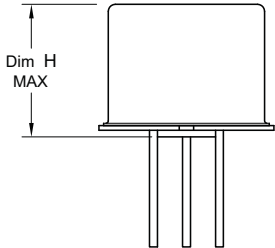
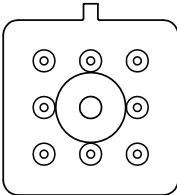
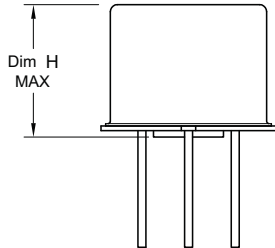
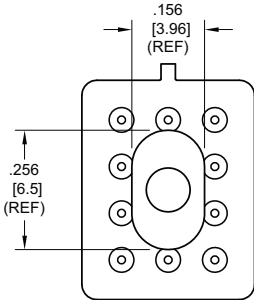
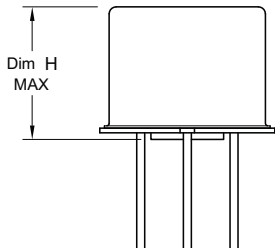
Appendix A: Spacer Pads

Pad designation and bottom view dimensions	Height	For use with the following:	Dim. H Max.
 <p style="text-align: center;">“M4” Pad for TO-5</p>		ER411T ER412, ER412D, ER412DD	.295 (7.49)
		712, 712D, 712TN, RF300, RF310, RF320	.300 (7.62)
		ER420, ER422D, ER420DD, 421, ER421D, ER421DD, ER422, ER422D, ER422DD, 722, 722D, RF341	.305 (7.75)
		ER431T, ER432T, ER432, ER432D, ER432DD	.400 (10.16)
		732, 732D, 732TN, RF303, RF313, RF323	.410 (10.41)
		RF312	.350 (8.89)
 <p style="text-align: center;">“M4” Pad for TO-5</p>		ER411, ER411D, ER411DD	.295 (7.49)
		ER431, ER431D, ER431DD	.400 (10.16)
		RF311	.300 (7.62)
		RF331	.410 (10.41)
 <p style="text-align: center;">“M4” Pad for Centigrid®</p>		172, 172D	.305 (7.75)
		ER114, ER114D, ER114DD, J114, J114D, J114DD	.300 (7.62)
		ER134, ER134D, ER134DD, J134, J134D, J134DD	.400 (10.16)
		RF100	.315 (8.00)
		RF103	.420 (10.67)
 <p style="text-align: center;">“M9” Pad for Centigrid®</p>		122C, A152	.320 (8.13)
		ER116C, J116C	.300 (7.62)
		ER136C, J136C	.400 (10.16)
		RF180	.325 (8.25)
		A150	.305 (7.75)

Notes:

1. Spacer pad material: Polyester film.
2. To specify an “M4” or “M9” spacer pad, refer to the mounting variants portion of the part numbering example in the applicable datasheet.
3. Dimensions are in inches (mm).
4. Unless otherwise specified, tolerance is $\pm .010$ (.25).
5. Add 10 m Ω to the contact resistance show in the datasheet.
6. Add 0.01 oz. (0.25 g) to the weight of the relay assembly shown in the datasheet.

Appendix A: Spreader Pads

Pad designation and bottom view dimensions	Height	For use with the following:	Dim. H Max.
<p>“M” Pad <u>5/</u> <u>6/</u></p>		ER411T, J411T, ER412, ER412D ER412DD, J412, J412D, J412DD ER412T, J412T	.388 (9.86)
		712, 712D, 712TN	.393 (9.99)
		ER431T, J431T, ER432, ER432D ER432DD, J432, J432D, J432DD ER432T, J432T	.493 (12.52)
		732, 732D, 732TN	.503 (12.78)
		ER420, J420, ER420D, J420D ER420DD, J420DD, ER421, J421 ER421D, J421D, ER421DD J422D, ER422DD, J422DD, 722	.398 (10.11)
<p>“M2” Pad <u>7/</u> <u>8/</u></p>		ER411T ER412, ER412D, ER412DD J412, J412D, J412DD	.441 (11.20)
		712, 712D	.451 (11.46)
		ER421, ER421D, ER421DD 722, 732D	.451 (11.46)
		ER431T ER432, ER432D, ER432DD	.546 (13.87)
		732, 732D	.556 (14.12)
<p>“M3” Pad <u>5/</u> <u>6/</u> <u>9/</u></p>		ER411, ER411D, ER411DD ER411TX ER412X, ER412DX, ER412DDX ER412TX	.388 (9.86)
		712X, 712DX, 712TNX	.393 (9.99)
		ER420X, ER420DX, ER420DDX ER421X, ER421DX, ER421DDX ER422X, ER422DX ER422DDX, 722X, 722DDX	.398 (10.11)
		ER431, ER431D, ER431DD ER431TX ER432X, ER432DX, ER432DDX ER432TX	.493 (12.52)
		732X, 732DX, 732TNX	.503 (12.78)

Notes:

1. Spreader pad material: Diallyl Phthalate.
2. To specify an “M”, “M2” or “M3” spreader pad, refer to the mounting variants portion of the part number example in the applicable datasheet.
3. Dimensions are in inches (mm).
4. Unless otherwise specified, tolerance is $\pm .010$ ” (0.25).
- 5/. Add 25 mΩ to the contact resistance shown in the datasheet.
- 6/. Add .01 oz. (0.25 g) to the weight of the relay assembly shown in the datasheet.
- 7/. Add 50 mΩ to the contact resistance shown in the datasheet.
- 8/. Add 0.025 oz (0.71 g) to the weight of the relay assembly shown in the datasheet.
- 9/. M3 pad to be used only when the relay has a center pin (e.g. ER411M3-12A, 722XM3-26.)

Appendix A: Ground Pin Positions

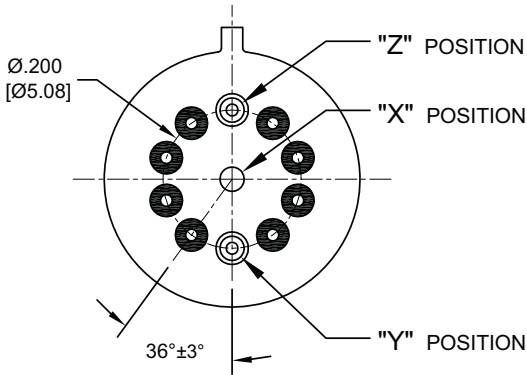

TO-5 Relays:

ER411T, ER412, ER412T, ER420, ER421, ER422, ER431T, ER432, ER432T, 712, 712TN, 400H, 400K, 400V, RF300, RF303, RF341, RF312, RF310, RF313, RF320, RF323

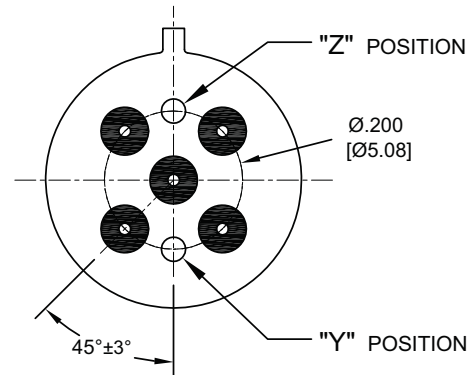

TO-5 Relays:

ER411, ER431, RF311, RF331

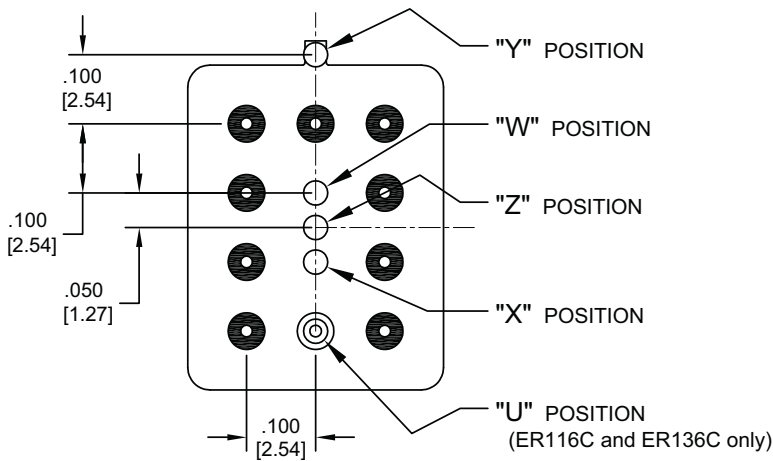

Centigrid® Relays:

RF180, ER116C, 122C, ER136C

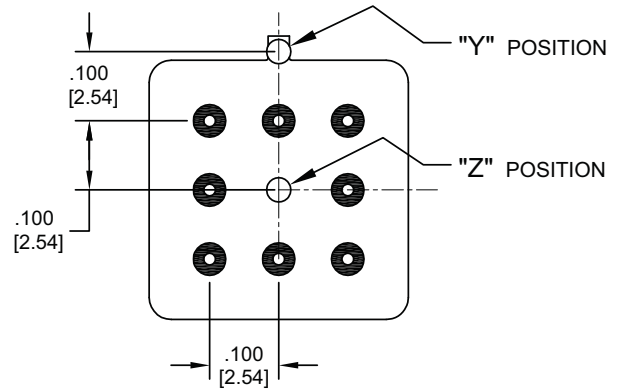

Centigrid® Relays:

RF100, RF103, ER114, ER134, 172

- Indicates ground pin position
- Indicates glass insulated lead position
- ◎ Indicates ground pin or lead position depending on relay type

NOTES

1. Terminal views shown
2. Dimensions are in inches (mm)
3. Tolerances: $\pm .010$ ($\pm .25$) unless otherwise specified
4. Ground pin positions are within $.015$ (0.38) dia. of true position
5. Ground pin head dia., 0.035 (0.89) ref; height 0.010 (0.25) ref.
6. Lead dia. 0.017 (0.43) nom.