

**Ultra-low power, compact and lightweight, High breakdown voltage,
 Surface mounting type**

DESCRIPTION

NEC TOKIN's new miniature signal relays, ED2/EF2 series, achieved 50 mW of ultra low power consumption.

FEATURES

- Low power consumption (50 mW)
 - Applicable for the surge voltage standard of FCC (1500 V, 10 × 160 μs) and Telcordia (2500 V, 2 × 10 μs)
 - Two types for through-hole mounting (ED2 series) and surface mounting (EF2 series)
 - Variation of dense mounting type and/or long-joint-life type for latest SMT
 - Compatible configuration and terminal allocation with dense mounting type of EE2 series
 - Upgraded soldering joint reliability between the relay terminal and PCB by optimization of the terminal configuration;
- 20-year-joint-life under 35°C-per-day-temperature-difference specified in IPC-SM-785 for telecommunication equipment

APPLICATIONS

Electronic switching systems, PBX, terminal equipment, telephone system.

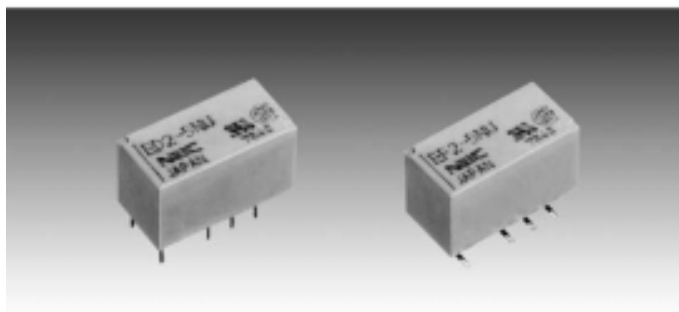

For Right Use of Miniature Relays

DO NOT EXCEED MAXIMUM RATINGS.

Do not use relays under exceeding conditions such as over ambient temperature, over voltage and over current. Incorrect use could result in abnormal heating, damage to related parts or cause burning.

READ CAUTIONS IN THE SELECTION GUIDE.

Read the cautions described in NEC/TOKIN's "Miniature Relays" when you choose relays for your application.

The information in this document is subject to change without notice.

DIMENSIONS AND PAD LAYOUTS (Unit : mm (inch))

ED2 SERIES

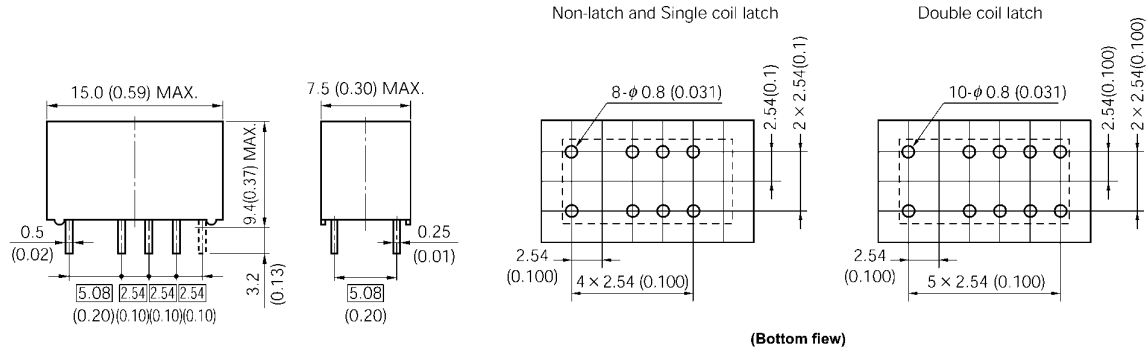

Note. General tolerance : ± 0.2 (± 0.008)
 Dimensions in \square show basic size.
 NJ type : Leads-2.8 mm (0.110)

Note. General tolerance : ± 0.1 (± 0.004)

EF2 SERIES

EF2-..
 EF2-..NU

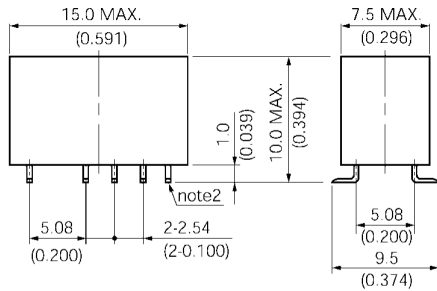

EF2-..NUX

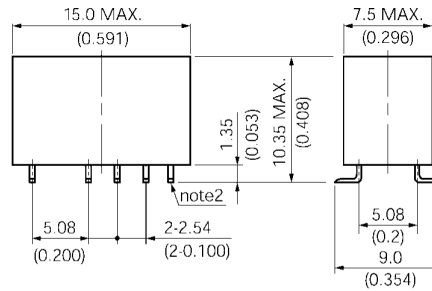

EF2-..NUH

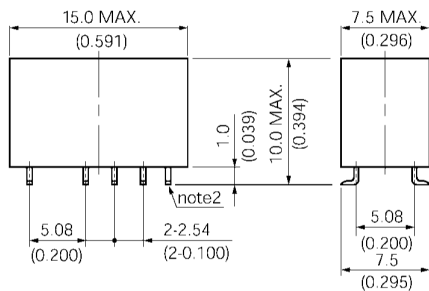

Note 1. General tolerance : ± 0.2 (± 0.008)

Note 2. This pair of pins at the right end applies to double coil latch type only.

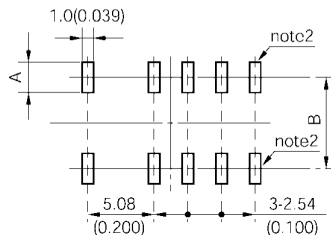

(Bottom view)

Type	A	B
EF2-..	3.0 (0.118)	7.29 (0.287)
EF2-..NU	3.0 (0.118)	7.29 (0.287)
EF2-..NUX	2.73 (0.107)	7.02 (0.276)
EF2-..NUH	2.0 (0.079)	6.29 (0.248)

Note 1. General tolerance : ± 0.1 (± 0.004)

Note 2. This pair of pads at the right end applies to double coil latch type only.

PIN CONFIGURATIONS (bottom view)

ED2 SERIES

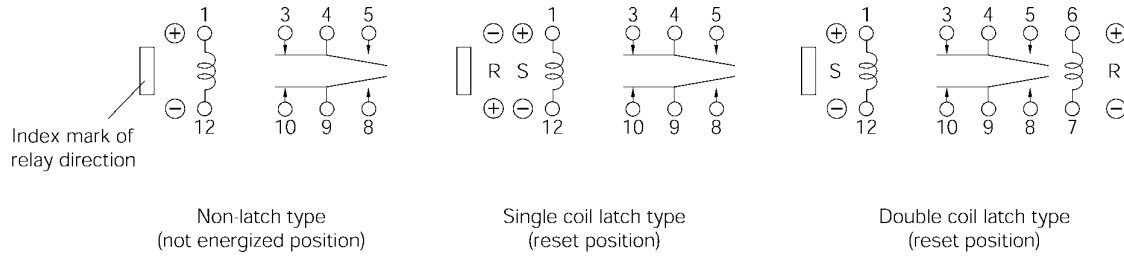

S : Coil polarity of set (operate)
R : Coil polarity of reset (release)

EF2 SERIES

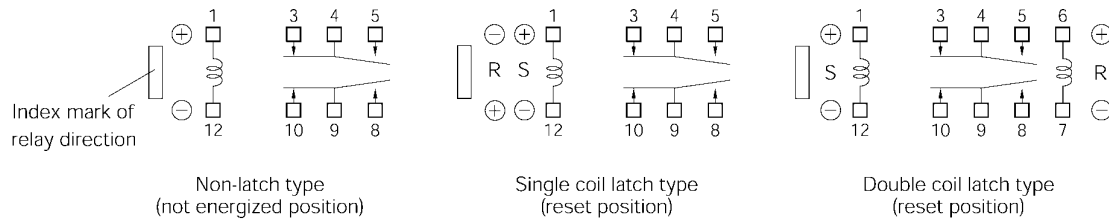

S : Coil polarity of set (operate)
R : Coil polarity of reset (release)

MARKINGS (top view)

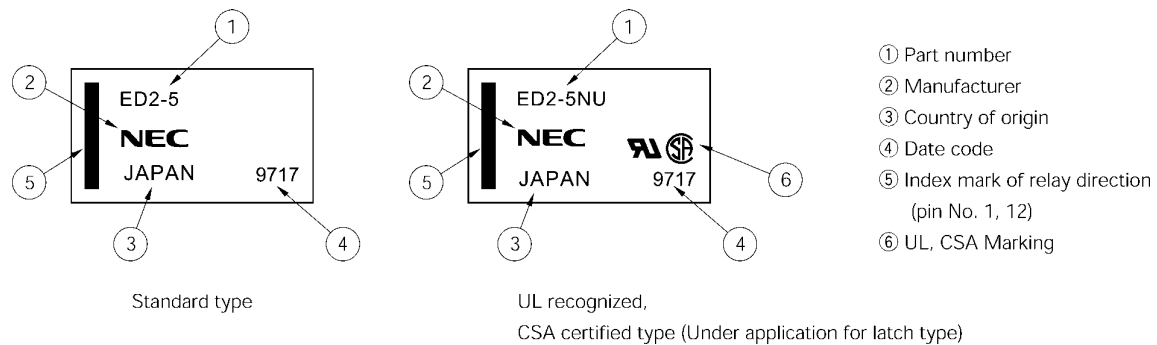

SAFETY STANDARD AND RATING

UL Recognized (UL508)* File No E73266	CSA Certified (CSA C22.2 No14) File No LR46266
30 Vdc, 1 A (Resistive)	
110 Vdc, 0.3 A (Resistive)	
125 Vac, 0.5 A (Resistive)	

* Spacing : UL114, UL478

TUV Certified (EN60255/IEC60255) No.9950557
Nonlatch and Single-coil latch
Creepage and clearance of coil to contact is over than 2 mm (According EN60950)
Basic insulation class

PERFORMANCE CHARACTERISTICS

Contact Form		2 Form c	
Contact Ratings	Maximum Switching Power	30 W (resistive)	62.5 VA (resistive)
	Maximum Switching Voltage	220 Vdc	250 Vac
	Maximum Switching Current	1 A	
	Maximum Carrying Current	2 A	
Minimum Contact Ratings		10 mV. dc, 10 μ A *4	
Initial Contact Resistance		75 m Ω max. (Initial)	
Contact Material		Silver alloy with gold alloy overlay	
Nominal Operating Power	Non-Latch Type	50 to 70 mW	
	Single Coil Latch Type	30 to 80 mW	
	Double Latch Type	50 to 80 mW	
Operate Time (Excluding Bounce)		Approximately 3 ms	
Release Time (Excluding Bounce)		Approximately 2 ms without diode	
Insulation Resistance		1000 M Ω at 500 Vdc	
Breakdown Voltage	Between Open Contacts	1000 Vac for one minute (1500 V surge, (10 \times 160 μ s *1)	
	Between Adjacent Contacts		
	Between Coil to Contact	Non-latch type and single-coil latch type 1500 Vac for one minute (2500 V surge, 2 \times 10 μ s *2) Double-coil latch type 1000 Vac for one minute (1500 V surge, 10 \times 160 μ s *1)	
Shock Resistance		735 m / s ² (misoperating) 980 m / s ² (destructive failure)	
Vibration Resistance		10 to 55 Hz at double amplitude at 3 mm (misoperating) 10 to 55 Hz, double amplitude of 5 mm (Destructive failure)	
Ambient Temperature		Non-latch type (Additional "N"): - 40 to +85°C Non-latch type (Standard): - 40 to +70°C Latch type : - 40 to +70°C	
Coil Temperature Rise		7 degrees at nominal coil voltage (50 mW)	
Running specifications	No-load	1 \times 10 ⁸ *3 operations (Non-latch type)	
		1 \times 10 ⁷ operations (Latch type)	
	Load	50 Vdc 0.1 A (resistive), 1 \times 10 ⁸ operations at 70°C 10 Vdc 10 mA (resistive), 1 \times 10 ⁸ operations at 70°C	
Weight		Approximately 2.2 grams	

*1 rise time : 10 μ s, decay time to half crest : 160 μ s

*2 rise time : 2 μ s, decay time to half crest : 10 μ s

*3 This shows a number of operation where it can be running by which a fatal defect is not caused, and a number of operation by which a steady characteristic is maintained is 1 \times 10⁷ operations.

*4 This value is a reference value in the resistance load.

Minimum capacity changes depending on switching frequency and environment temperature and the load.

Recommended relay drive conditions

Drive under conditions. If it is impossible, please inquire to NEC.

Additional "N" type of non-latch	Voltage: within \pm 5% at nominal voltage	Ambient temperature - 40 to +85°C
standard type of non-latch		Ambient temperature - 40 to +70°C
Single coil latch type	Square pulse (rise and fall time is rapidly) Pulse height : within \pm 5% at nominal voltage Pulse width : More than 10 ms	Ambient temperature - 40 to +70°C

PART NUMBER SYSTEM

ED2 - 9 S NU

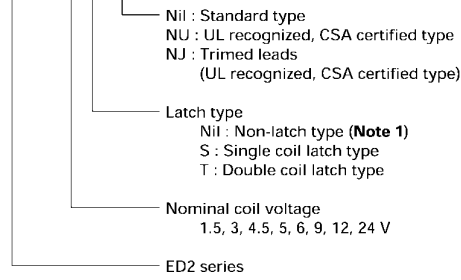

EF2 - 5 S NU - L

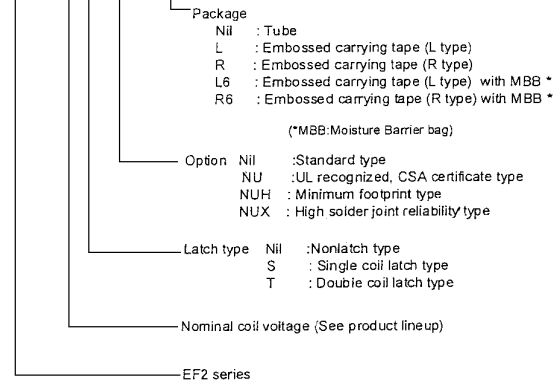

Note 1. There are two specification in operate voltage of Non-latch type relay.

	Part Number	Must Operate Voltage
Additional "N" type	ED2- *NU - *NJ	75%
Standard type	ED2- *	80%

* : Nominal coil voltage

Note 2. There are two specification in operate voltage of Non-latch type relay.

	Part Number	Must Operate Voltage
Additional "N" type	ED2- *NU - *NUX - *NUH	75%
Standard type	EF2- *	80%

* : Nominal coil voltage

NOMINAL LINEUP (Community)

Non-latch Type (Standard)

at 20°C

Nominal Coil Voltage (Vdc)	Coil Resistance (Ω) ± 10 %	Must Operate Voltage (Vdc)	Must Release Voltage (Vdc)	Nominal operate power (mW)
1.5	45	1.2	0.15	50
3	180	2.4	0.3	50
4.5	405	3.6	0.45	50
5	500	4	0.5	50
6	720	4.8	0.6	50
9	1473	7.2	0.9	55
12	2400	9.6	1.2	60
24	8229	19.2	2.4	70

Non-latch Type (Additional "N")

at 20°C

Nominal Coil Voltage (Vdc)	Coil Resistance (Ω) ± 10 %	Must Operate Voltage (Vdc)	Must Release Voltage (Vdc)	Nominal operate power (mW)
1.5	45	1.13	0.15	50
3	180	2.25	0.3	50
4.5	405	3.38	0.45	50
5	500	3.75	0.5	50
6	720	4.5	0.6	50
9	1473	6.75	0.9	55
12	2400	9	1.2	60
24	8229	18	2.4	70

Single-Coil Latch Type

at 20°C

Nominal Coil Voltage (Vdc)	Coil Resistance (Ω) ± 10 %	Must Operate Voltage (Vdc)	Must Release Voltage (Vdc)	Nominal operate power (mW)
1.5	75	1.2	1.2	30
3	300	2.4	2.4	30
4.5	675	3.6	3.6	30
5	833	4	4	30
6	1200	4.8	4.8	30
9	2700	7.2	7.2	30
12	4800	9.6	9.6	30
24	7200	19.2	19.2	80

Double-Coil Latch Type

at 20°C

Nominal Coil Voltage (Vdc)	Coil Resistance (Ω) $\pm 10\%$		Must Operate Voltage (Vdc)	Must Release Voltage (Vdc)	Nominal operate power (mW)
1.5	S	45	1.2	-	50
	R	45	-	1.2	
3	S	180	2.4	-	50
	R	180	-	2.4	
4.5	S	405	3.6	-	50
	R	405	-	3.6	
5	S	500	4	-	50
	R	500	-	4	
6	S	720	4.8	-	50
	R	720	-	4.8	
9	S	1620	7.2	-	50
	R	1620	-	7.2	
12	S	2880	9.6	-	50
	R	2880	-	9.6	

PERFORMANCE DATA

COIL TEMPERATURE RISE

Temperature is measured by coil resistance.

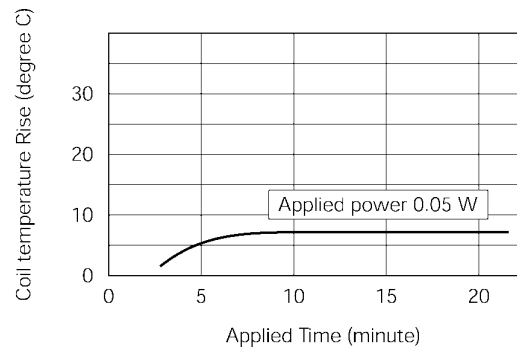
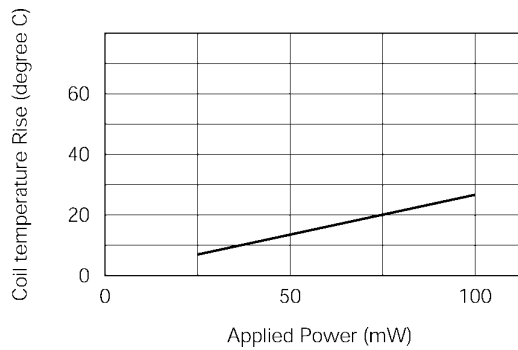

SWITCHING CAPACITY

This is allowed maximum value.

Inquiry for NEC/TOKIN under maximum value at continuous use.

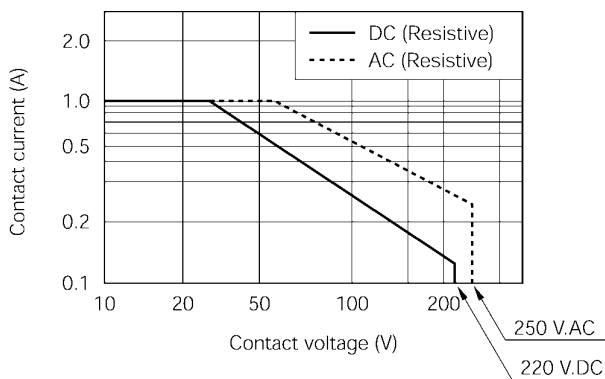

MAXIMUM COIL VOLTAGE

This is maximum value of permissible alteration.

Inquiry for NEC/TOKIN at continuous use.

(Latch type and standard type of non-latch)

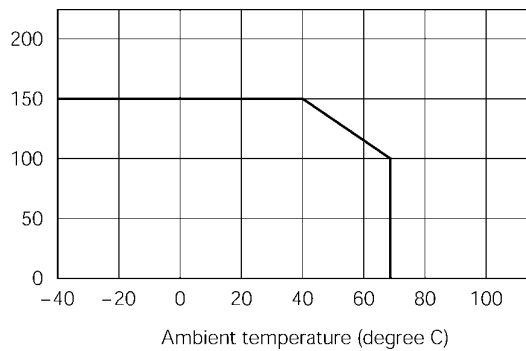

(Additional "N" type of non-latch)

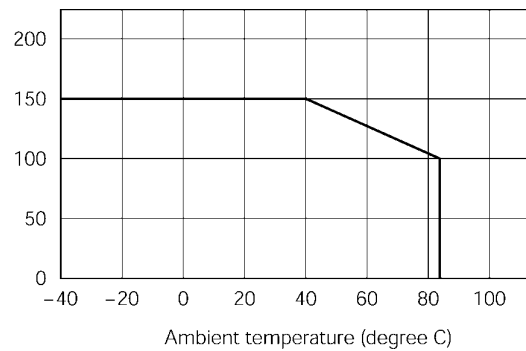

APPLIED VOLTAGE VS. TIMING (Sample: ED2-5NU)

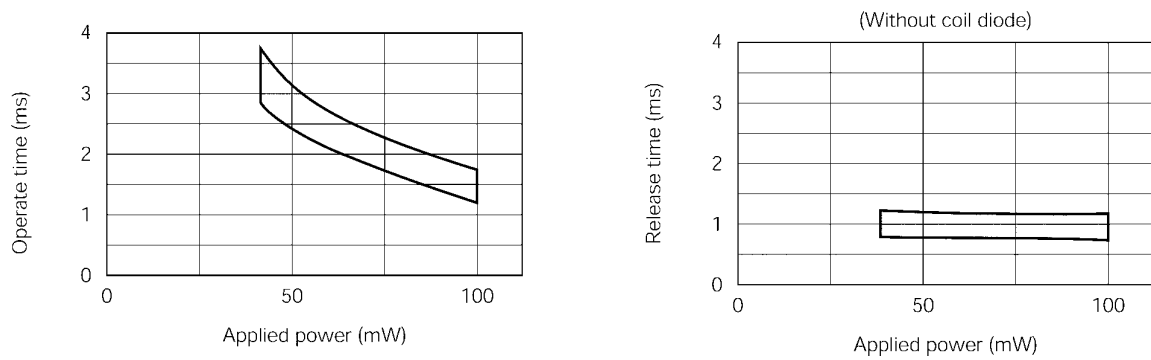

OPERATE AND RELEASE VOLTAGE VS. AMBIENT TEMPERATURE

This shows a typical change of operate (release) voltage. Maximum value of operate estimated, so it must be applied more than this value for safety operation. In case of "hot start operation", please inquiry for NEC/TOKIN.

(Latch type and standard type of non-latch)

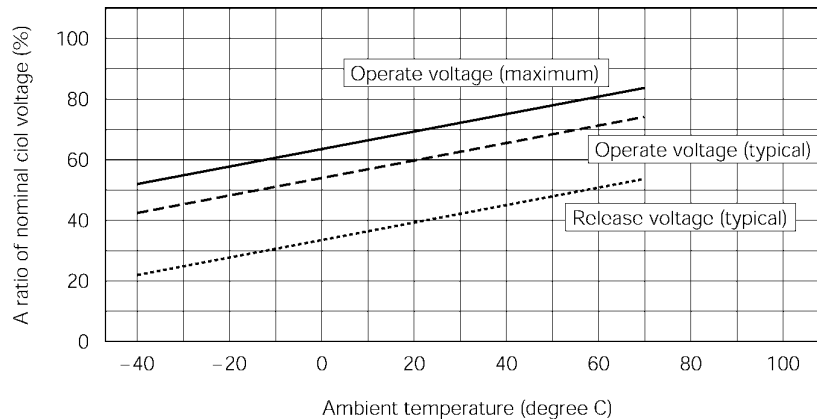

(Additional "N" type of non-latch)

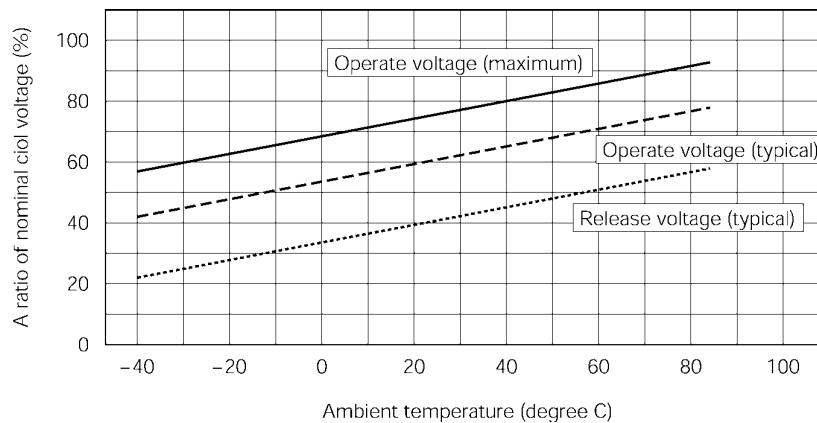

RUNNING TEST (Nonload)

(Load: None, Driving: 5V.DC, 50 Hz, 50% duty, Ambient temperature: Room temperature, Sample: ED2-5NU 20 pieces)

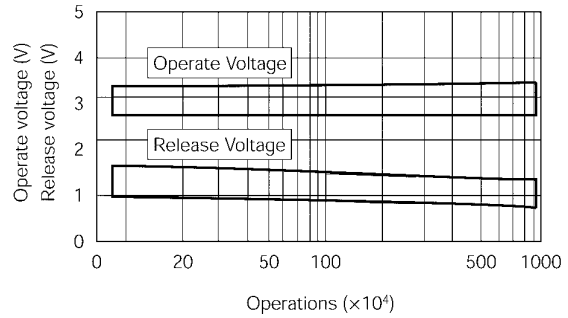
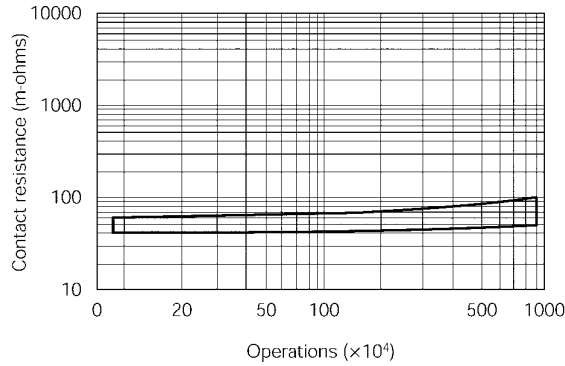

RUNNING TEST (Load)

(Load: 50 V.DC 0.1 A resistive, Driving: 5V.DC, 5 Hz, 50% duty, Ambient temperature: 85 degree C, Sample: ED2-5NU 10 pieces)

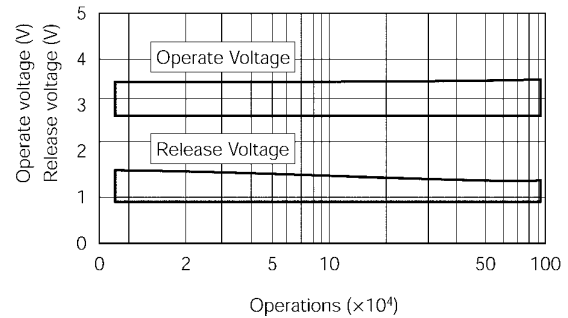
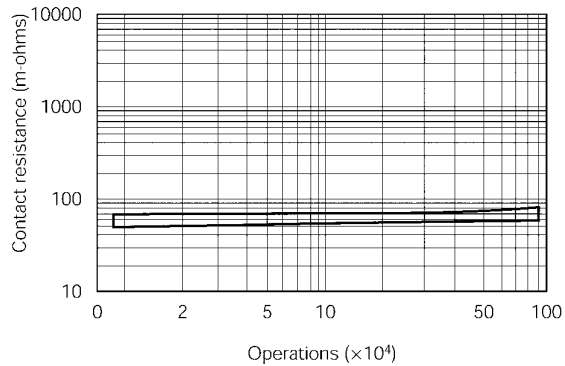

BREAKDOWN VOLTAGE

Sample: ED2-5NU 10 pieces

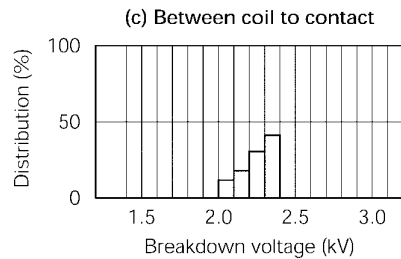
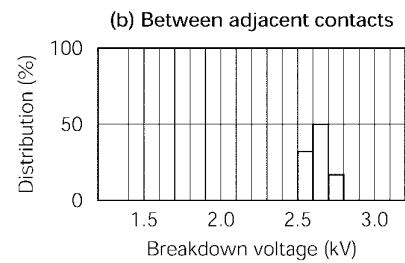
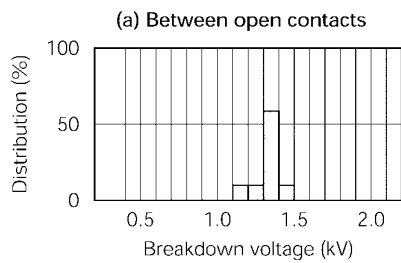

ALTERNATION OF VOLTAGE AT DENSELY MOUNTING (Magnet interference)

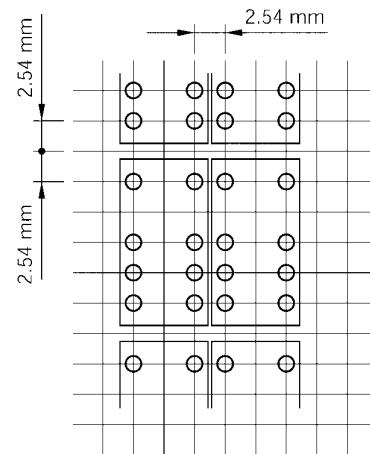
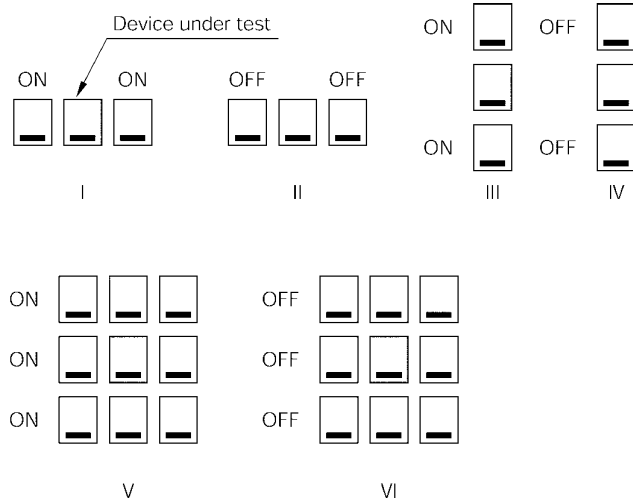
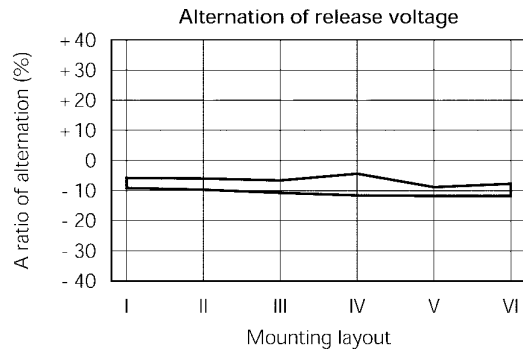
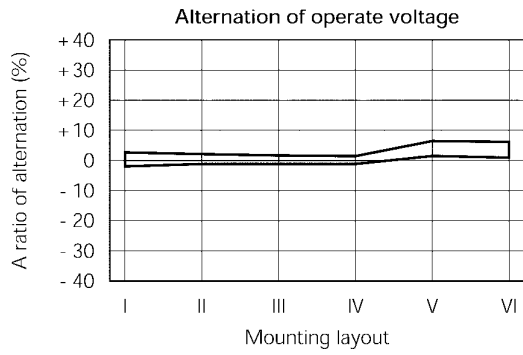

TUBE PACKAGE (ED2, EF2)

Dimension of Package (Unit : mm)

35 pieces / Tube
 Material : Polyvinyl chloride
 (anti-static treated)

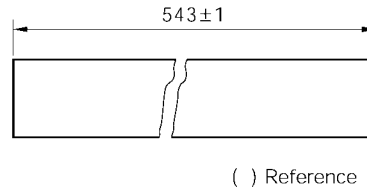
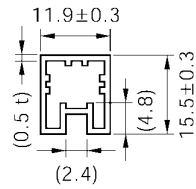

Outline of Package

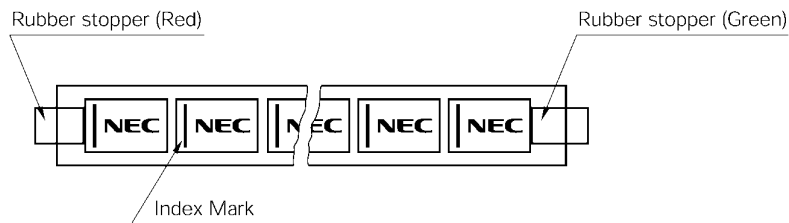

TAPE PACKAGE (EF2)

APPEARANCE

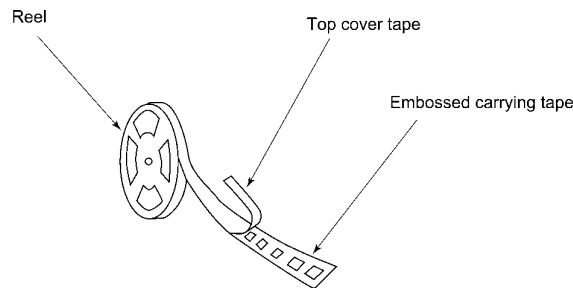

TAPE DIMENSION mm (inch)

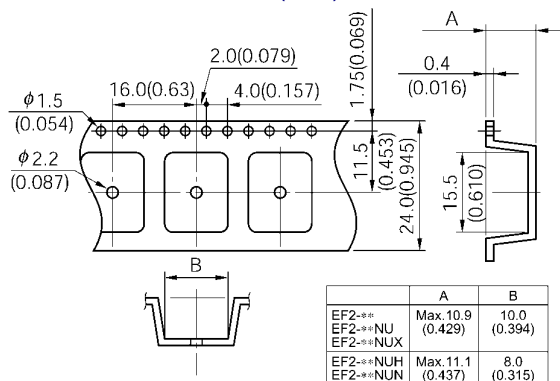

Relay orientation mark and tape carrying direction.

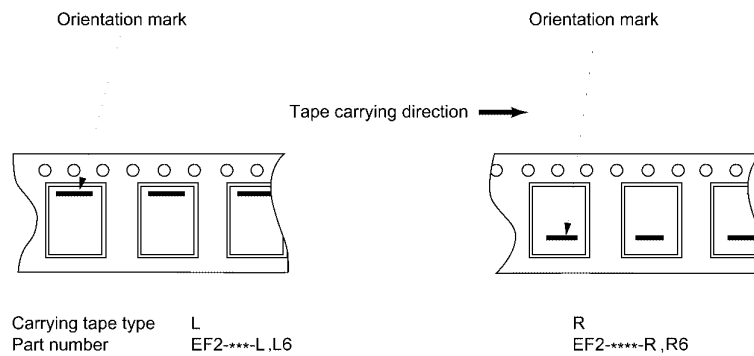

SOLDERING TEMPERATURE CONDITION

Through-hole mounting type (ED2)

Automatic soldering

- * Preheating : 100°C max. 1 minute max.
- * Solder temperature : 260°C max.
- * Solder time : 5 seconds max.

Manual soldering

- * Solder temperature : 350°C max.
- * Solder time : 3 seconds max.

Surface mounting type (EF2)

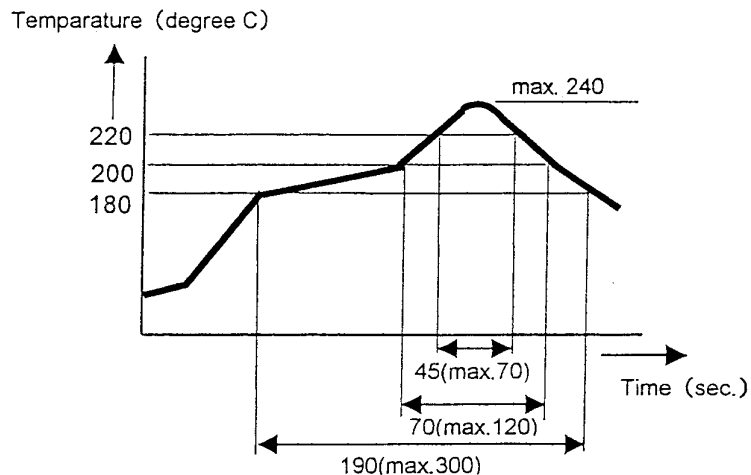

Note:

1. Temperature profile shows printed circuit board surface temperature on the relay terminal portion.
2. Check the actual soldering condition to use other method except above mentioned temperature profiles.

Notes on Correct Use

1. Notes on contact load

Make sure that the contact load is within the specified range; otherwise, the lifetime of the contacts will be shortened considerably. Note that the running performance shown is an example, and that it varies depending on parameters such as the type of load, switching frequency, driver circuit, and ambient temperature under the actual operating conditions. Evaluate the performance by using the actual circuit before using the relay.

2. Driving relays

- If the internal connection diagram of a relay shows + and - symbols on the coil, apply the rated voltage to the relay in the specified direction. If a rippled DC current source is used, abnormalities such as beat at the coil may occur.
- The maximum voltage that can be applied to the coil of the relay varies depending on the ambient temperature. Generally, the higher the voltage applied to the coil, the shorter the operating time. Note, however, that a high voltage also increases the bounce of the contacts and the contact opening and closing frequency, which may shorten the lifetime of the contacts.
- If the driving voltage waveform of the relay coil rises and falls gradually, the inherent performance of the relay may not be fully realized. Make sure that the voltage waveform instantaneously rises and falls as a pulse.

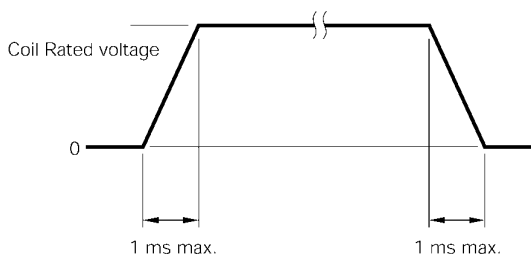

- For a latching relay, apply a voltage to the coil according to the polarity specified in the internal connection diagram of the relay.
- If a current is applied to the coil over a long period of time, the coil temperature rises, promoting generation of organic gas inside the relay, which may result in faulty contacts. In this case, use of a latching relay is recommended.
- The operating time and release time indicate the time required for each contact to close after the voltage has been applied to or removed from the coil. However, because the relay has a mechanical structure, a bounce state exists at the end of the operating and release times. Furthermore, because additional time is required until the contact stabilizes after being in a high-resistance state, care must be taken when using the relay at high speeds.

3. Operating environment

- Make sure that the relay mounted in the application set is used within the specified temperature range. Use of a relay at a temperature outside this range may adversely affect insulation or contact performance.
- If the relay is used for a long period of time in highly humid (RH 85% or higher) environment, moisture may be absorbed into the relay. This moisture may react with the NOx and SOx generated by glow discharges that occur when the contacts are opened or closed,

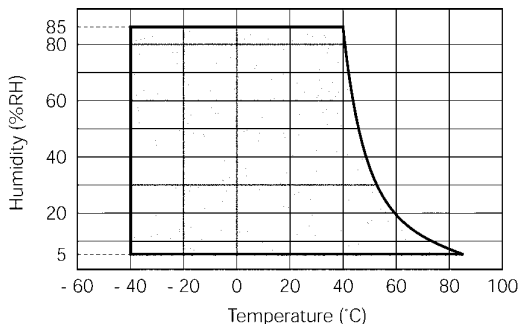

producing nitric or sulfuric acid. If this happens, the acid produced may corrode the metallic parts of the relay, causing operational malfunction.

- Because the operating temperature range varies depending on the humidity, use the relay in the temperature range illustrated in the figure below. Prevent the relay from being frozen and avoid the generation of condensation.
- The relay maintains constant sealability under normal atmospheric pressure (810 to 1,200 hpa). Its sealability may be degraded or the relay may be deformed and malfunction if it is used under barometric conditions exceeding the specified range.
- The same applies when the relay is stored or transported. Keep the upper-limit value of the temperature to which the relay is exposed after it is removed from the carton box to within 50°C.
- If excessive vibration or shock is applied to the relay, it may malfunction and the contacts remain closed. Vibration or shock applied to the relay during operation may cause considerable damage to or wearing of the contacts. Note that operation of a snap switch mounted close to the relay or shock due to the operation of magnetic solenoid may also cause malfunctioning.

4. Notes on mounting relays

- When mounting a relay onto a PC board using an automatic chip moulder, if excessive force is applied to the cover of the relay when the relay is chucked or inserted, the cover may be damaged or the characteristics of the relay degraded. Keep the force applied to the relay to within 1 kg.
- Avoid bending the pins to temporarily secure the relay to the PC board. Bending the pins may degrade sealability or adversely affect the internal mechanism.
- It is recommended to solder the relay onto a PC board under the following conditions:

- <1> Reflow soldering
Refer to the recommended soldering temperature profile.
- <2> Flow soldering
Solder temperature: 260°C max., Time: 5 seconds max, Preheating: 100°C max./1 minute max.
- <3> Manual soldering
Solder temperature: 350°C, Time: 2 to 3 seconds

- Ventilation immediately after soldering is recommended.
- Avoid immersing the relay in cleaning solvent immediately after soldering due to the danger of thermal shock being applied to the relay.
- Use an alcohol-based or water-based cleaning solvent. Never use thinner and benzene because they may damage the relay housing.
- Do not use ultrasonic cleaning because the vibration energy generated by the ultrasonic waves may cause the contacts to remain closed.

5. Handling

- Relays are packaged in magazine cases for shipment. If a space is created in the case after some relays have been removed, be sure to insert a stopper to secure the remaining relays in the case. If relays are not well secured, vibration during transportation may cause malfunctioning of the contacts.
- Exercise care in handling the relay so as to avoid dropping it or allowing it to fall. Do not use a relay that has been dropped. If a relay drops from a workbench to the floor, a shock of 9,800 m/s² (1,000 G) or more is applied to the relay, possibly damaging its functions. Even if a light shock has been applied to the relay, thoroughly evaluate its operation before using it.
- Latching relays are factory-set to the reset state for shipment. A latching relay may be set, however, by vibration or shock applied while being transported. Be sure to forcibly reset the relay before using it in the application set. Also note that the relay may be set by unexpected vibration or shock when it is used in a portable set.
- The sealability of a surface-mount relay may be lost if the relay absorbs moisture and is then heated during soldering. When storing relays, therefore, observe the following points:
- <1> Please use relays within 12 months after delivery. (Storage conditions : 30 degrees C / 60% RH)
- <2> For MBB packing, Please use relays within 2 years after delivery. (Storage conditions : 30 degrees C / 60% RH)
- After opening MBB packing, Please use within 3 months. (Storage conditions : 30 degrees C / 60% RH)

No part of this document may be copied or reproduced in any form or by any means without the prior written consent of NEC/TOKIN Corporation. NEC/TOKIN Corporation assumes no responsibility for any errors which may appear in this document.

NEC/TOKIN Corporation does not assume any liability for infringement of patents, copyrights or other intellectual property rights of third parties by or arising from use of a device described herein or any other liability arising from use of such device. No license, either express, implied or otherwise, is granted under any patents, copyrights or other intellectual property rights of NEC/TOKIN Corporation or others. While NEC/TOKIN Corporation has been making continuous effort to enhance the reliability of its electronic components, the possibility of defects cannot be eliminated entirely. To minimize risks of damage or injury to persons or property arising from a defect in an NEC/TOKIN electronic component, customers must incorporate sufficient safety measures in its design, such as redundancy, fire-containment, and anti-failure features. NEC/TOKIN devices are classified into the following three quality grades:

"Standard", "Special", and "Specific". The Specific quality grade applies only to devices developed based on a customer designated "quality assurance program" for a specific application. The recommended applications of a device depend on its quality grade, as indicated below. Customers must check the quality grade of each device before using it in a particular application.

Standard: Computers, office equipment, communications equipment, test and measurement equipment, audio and visual equipment, home electronic appliances, machine tools, personal electronic equipment and industrial robots

Special: Transportation equipment (automobiles, trains, ships, etc.), traffic control systems, anti-disaster systems, anti-crime systems, safety equipment and medical equipment (not specifically designed for life support)

Specific: Aircrafts, aerospace equipment, submersible repeaters, nuclear reactor control systems, life support systems or medical equipment for life support, etc.

The quality grade of NEC/TOKIN devices is "Standard" unless otherwise specified in NEC/TOKIN's Data Sheets or Data Books. If customers intend to use NEC/TOKIN devices for applications other than those specified for Standard quality grade, they should contact an NEC/TOKIN sales representative in advance.

(Note)

- (1) "NEC/TOKIN" as used in this statement means NEC/TOKIN Corporation and also includes its majorityowned subsidiaries.
- (2) "NEC/TOKIN electronic component products" means any electronic component product developed or manufactured by or for NEC/TOKIN (as defined above).

DE0202