

1		
Description	Material	Finish
Nut	Brass	Nickel
Washer	Brass	Nickel
Main Body	Brass	Nickel
Pin Insulator	Teflon	Teflon
Socket	BE CU	Gold
Spacer	Teflon	Teflon
Shield Sleeve	Brass	Nickel
Retaining Nut	Brass	Nickel
Crimp Ring	Brass	Nickel

RECOMMENDED CABLE STRIPPING DIMENSIONS

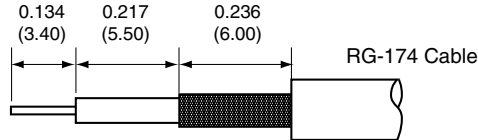

RECOMMENDED MOUNTING HOLE

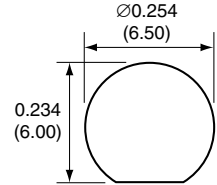

SIDE VIEW

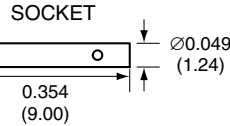
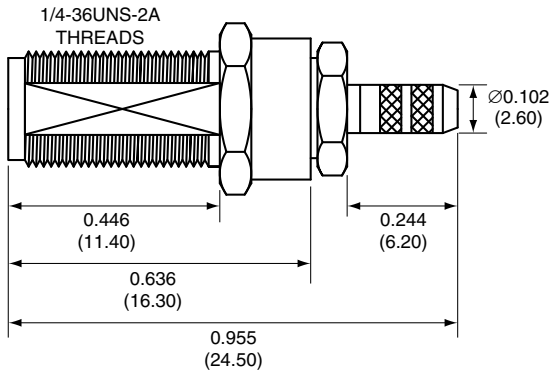

WASHER

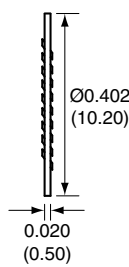

NUT

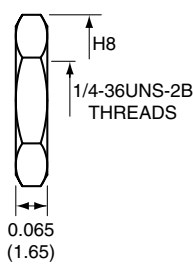

CRIMP RING

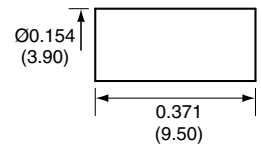

CONREVSMA005 ASSEMBLY INSTRUCTIONS

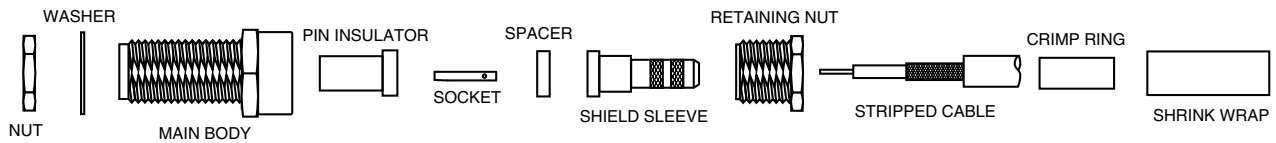

1. Insert the center conductor through the retaining nut, shield sleeve, and spacer.
2. Solder the pin to the center conductor.
3. Insert the pin into the pin insulator, then screw the main body onto the retaining nut.
4. Wrap the braid around the tail of the body and crimp the ring with a 0.137" hex crimp tool (or one labeled for use with RG-174 cable).
5. Use the shrink wrap to cover the crimp ring.
6. Use the nut and washer to secure the connector to a case.

Title SMA FEMALE BULKHEAD MOUNT CABLE END CRIMP FOR RG174 CABLE		CONNECTOR CITY 159 ORT LANE MERLIN, OR 97532	
Part No. CONSMA005	Revision: 1.0	PH (541)-471-6256 FAX (541)-471-6251	
Dimensions: INCHES (mm)	Date: 5/29/2007	Sheet 1 of 1	

**CONNECTOR CITY**  
THE VALUE OF CONNECTIONS

1

2

3

4