

Temperature Controller E5C2

1/16 DIN Sized, Analog-Set Controller Features Dual Scale Dial

- Proportional control (P) or ON/OFF control models.
- Front panel offset adjustment on P controllers.
- Choose contact or voltage outputs.
- Type J or K thermocouples, platinum RTD and thermistor input models.
- Panel mounting hardware included.
- Sockets, protective cover, and other accessories may be ordered separately.



Ordering Information

■ Temperature Controllers

Type K Thermocouple Input

Stock Note: Shaded models are normally stocked.

Control type	Input type	Output type	Temperature range	Model
ON/OFF	Type K	Relay	32°F - 1112°F	E5C2-R20K-32/1112F-AC120
				E5C2-R20K-32/1112F-AC240
		Voltage	32°F - 1112°F	E5C2-Q20K-32/1112F-AC120
				E5C2-Q20K-32/1112F-AC240
Proportional	Type K	Relay	32°F - 1112°F	E5C2-R40K-32/1112F-AC120
				E5C2-R40K-32/1112F-AC240
		Voltage	32°F - 1112°F	E5C2-Q40K-32/1112F-AC120
				E5C2-Q40K-32/1112F-AC240

Note: Other temperature ranges and scales available.

Type J Thermocouple Input

Stock Note: Shaded models are normally stocked.

Control type	Input type	Output type	Temperature range	Model
ON/OFF	Type J	Relay	0°C - 200°C and 32°F - 392°F	E5C2-R20J-0200C/32392F-AC120
			E5C2-R20J-0200C/32392F-AC240	
		Voltage	0°C - 400°C and 32°F - 752°F	E5C2-R20J-0400C/32752F-AC120
			E5C2-R20J-0400C/32752F-AC240	
Proportional	Type J	Voltage	32°F - 752°F	E5C2-Q20J-32/752F-AC120
				E5C2-Q20J-32/752F-AC240
		Relay	32°F - 572°F	E5C2-R40J-32/572F-AC120
				E5C2-R40J-32/572F-AC240
Voltage	32°F - 572°F	E5C2-Q40J-32/572F-AC120		
		E5C2-Q40J-32/572F-AC240		

Note: Other temperature ranges and scales available.

RTD Input

Stock Note: Shaded models are normally stocked.

Control type	Input type	Output type	Temperature range	Model
ON/OFF	RTD	Relay	32°F - 572°F	E5C2-R20P-32/572F-AC120
				E5C2-R20P-32/572F-AC240
		Voltage	32°F - 212°F	E5C2-Q20P-32/212F-AC240
				E5C2-Q20P-32/212F-AC120

Note: Other temperature ranges and scales available.

Thermistor Input

Stock Note: Shaded models are normally stocked.

Control type	Input type	Output type	Temperature range	Model
ON/OFF	Thermistor	Relay	32°F - 212°F	E5C2-R20G-32/212F-AC120
				E5C2-R20G-32/212F-AC240
		Voltage	32°F - 212°F	E5C2-Q20G-32/212F-AC120
				E5C2-Q20G-32/212F-AC240

Note: Other temperature ranges and scales available.

Accessories

Stock Note: Shaded models are normally stocked.

Description		Model
Sockets	Bottom surface or track mounting, top screw terminals	P2CF-08
	Back mounting, for use with Y92F-30 mounting adapter supplied, bottom screw terminals	P3G-08
	Back mounting plug type, for use with Y92F-30 mounting adapter supplied	US08
Protective cover	Hard plastic cover protects against accidental resetting	Y92A-48B
Mounting track	DIN rail, 50 cm (1.64 ft) length	PFP-50N
	DIN rail, 1 m (3.28 ft) length	PFP-100N
	End plate	PFP-M
	Spacer	PFP-S

Replacement Part

Stock Note: Shaded models are normally stocked.

Description	Model
Panel mounting bracket; one supplied with each controller	Y92F-30

Specifications

Model		E5C2-□□□K	E5C2-□□□J	E5C2-□□□P-DIN	E5C2-□□□G
Sensor input types		Thermocouple type K	Thermocouple type J	Platinum RTD	Thermistor
Supply voltage		100/120 VAC, 50/60 Hz or 220/240 VAC, 50/60 Hz			
Operating voltage		90% to 110% of rated supply voltage			
Power consumption		Approx. 2 VA			
Control	Number	One output, built-in			
	Type	Relay	SPDT, 3 A, 250 VAC (resistive load), switching capacity of 330 VA		
		Voltage	5 VDC, 10 mA with short-circuit protection		
	Hysteresis	0.5% max. of full scale (fixed)			
	Service life	100,000 electrical operations minimum for relay output 10 million mechanical operations minimum for relay output			
Alarm output		Not available			
Setting accuracy		±2% maximum of full scale			
Control modes	Type	ON/OFF (E5C2-□20□) or P (E5C2-□40□)			
	Proportional band	3% of full scale (fixed)			
	Reset	3% minimum of full scale (variable); front panel potentiometer adjustment			
	Control period	Approx. 20 seconds, where ratio of ON to OFF is 1:1			
Memory protection		Not available			
Indicators		Operation indicator (red LED)			
Materials		Plastic case			
Mounting		Fits 1/16 DIN panel cutouts; includes panel mounting adapter Y92F-30			
Connections		Terminals for standard 8-pin round connectors			
Weight		Approx. 200 f (7 oz.)			
Enclosure ratings		Front panel: IEC IP40, NEMA 4 with optional cover Y92A-48N Housing: IEC IP20 Terminals: IEC IP00			
Approvals	UL	Recognized, File No. E200593, approved control output rating 1.5 A, 250 VAC			
	CSA	Certified, File No. LR59623, approved control output rating 1.5 A, 250 VAC			
Ambient temperature	Use	-10° to 55°C (14° to 131°F)			
	Other	-25° to 65°C (-13° to 149°F)			
Humidity		35 to 85% RH			
Insulation resistance		20 M minimum at 500 VDC			
Dielectric strength		2,000 VAC, 50/60 Hz for 1 minute			
Vibration	Mechanical	10 to 55 Hz 0.75 mm (0.03 in) in X, Y, and Z directions for 2 hours each			
	Malfunction	2 to 55 Hz, 2 G, in X, Y, and Z directions for 10 minutes each			
Shock	Mechanical	300 m/s ² in 6 directions, 3 times each			
	Malfunction	200 m/s ² in 6 directions, 3 times each			

Dimensions

Unit: mm (inch)

Temperature Controller

E5C2

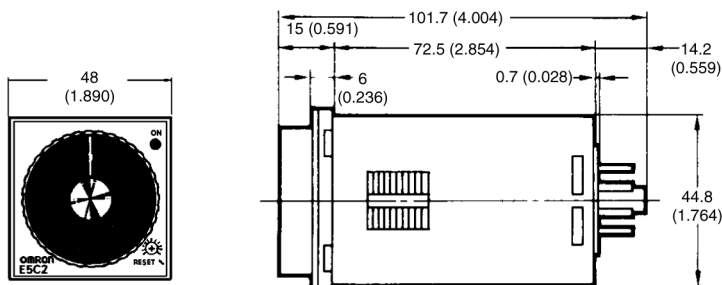

Panel cutout

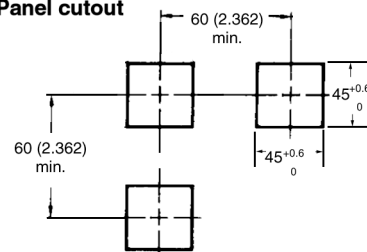

Note: Recommended panel thickness is 1 mm to 4 mm (0.039 to 0.157).

E5C2 Temperature Controller Mounted in Y92F-30 Panel Mounting Adapter (supplied)

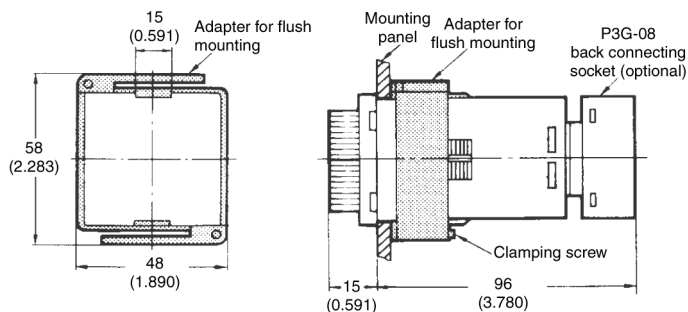

Sockets

P2CF-08 Bottom Surface or Track Mounting Socket

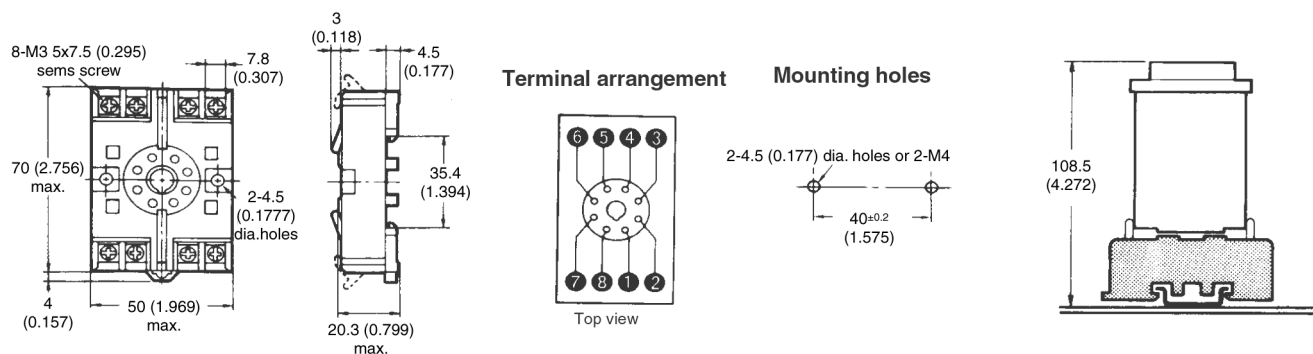

P3G-08 Back Mounting Socket

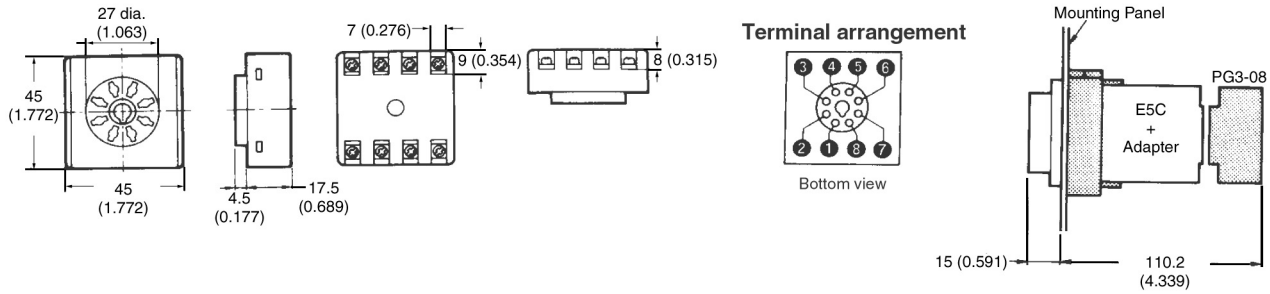

US08 Back-Mounting Socket

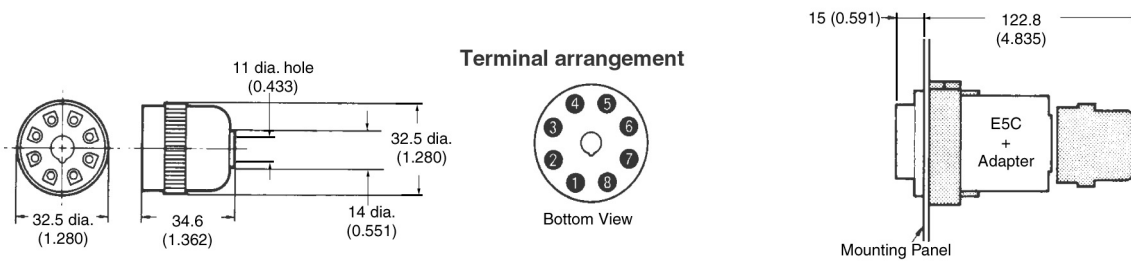

■ Protective Cover

Y92A-48B

Hard plastic cover Y92A-48B snaps onto the front of the temperature controller to prevent accidental resetting. It also shields the front panel from dirt and water. The cover is intended for use in areas where unusual service conditions do not exist.

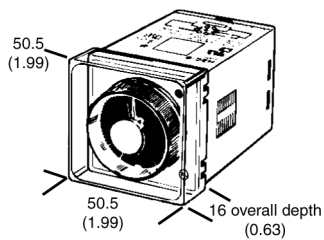

■ Mounting Track and Accessories

PFP-100N/PFP-50N DIN Rail

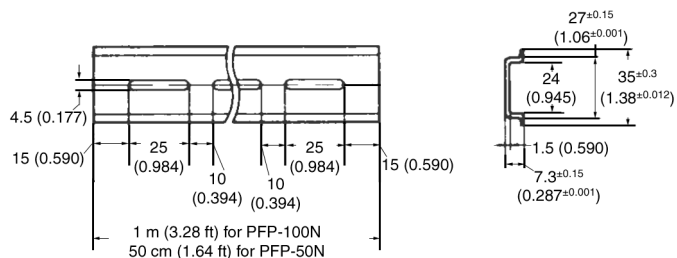

PFP-M End Plate

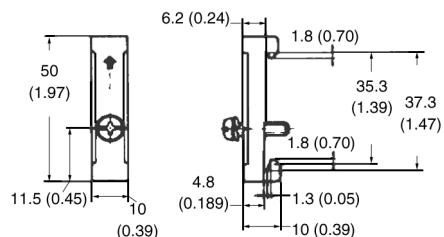

PFP-S Spacer

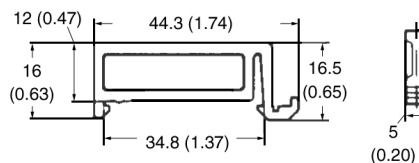

Nomenclature

■ E5C2

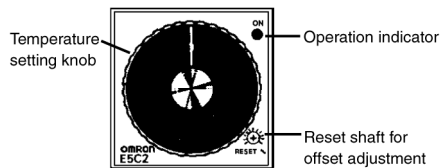

Connections

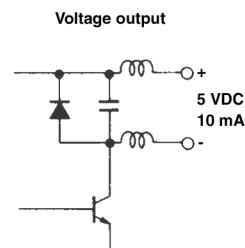
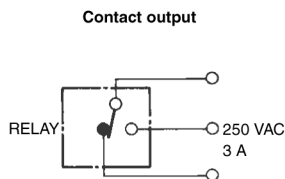
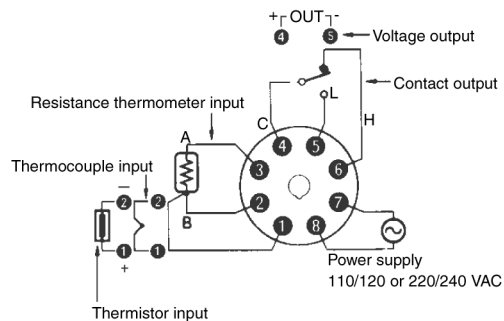

Certain Terms and Conditions of Sale

1. **Offer; Acceptance.** These terms and conditions (these "Terms") are deemed part of all catalogs, manuals or other documents, whether electronic or in writing, relating to the sale of goods or services (collectively, the "Goods") by Omron Electronics LLC and its subsidiary companies ("Seller"). Seller hereby objects to any terms or conditions proposed in Buyer's purchase order or other documents which are inconsistent with, or in addition to, these Terms. Please contact your Omron representative to confirm any additional terms for sales from your Omron company.
2. **Prices.** All prices stated are current, subject to change without notice by Seller. Buyer agrees to pay the price in effect at time of shipment.
3. **Discounts.** Cash discounts, if any, will apply only on the net amount of invoices sent to Buyer after deducting transportation charges, taxes and duties, and will be allowed only if (i) the invoice is paid according to Seller's payment terms and (ii) Buyer has no past due amounts owing to Seller.
4. **Orders.** Seller will accept no order less than \$200 net billing.
5. **Governmental Approvals.** Buyer shall be responsible for, and shall bear all costs involved in, obtaining any government approvals required for the importation or sale of the Goods.
6. **Taxes.** All taxes, duties and other governmental charges (other than general real property and income taxes), including any interest or penalties thereon, imposed directly or indirectly on Seller or required to be collected directly or indirectly by Seller for the manufacture, production, sale, delivery, importation, consumption or use of the Goods sold hereunder (including customs duties and sales, excise, use, turnover and license taxes) shall be charged to and remitted by Buyer to Seller.
7. **Financial.** If the financial position of Buyer at any time becomes unsatisfactory to Seller, Seller reserves the right to stop shipments or require satisfactory security or payment in advance. If Buyer fails to make payment or otherwise comply with these Terms or any related agreement, Seller may (without liability and in addition to other remedies) cancel any unshipped portion of Goods sold hereunder and stop any Goods in transit until Buyer pays all amounts, including amounts payable hereunder, whether or not then due, which are owing to it by Buyer. Buyer shall in any event remain liable for all unpaid accounts.
8. **Cancellation; Etc.** Orders are not subject to rescheduling or cancellation unless Buyer indemnifies Seller fully against all costs or expenses arising in connection therewith.
9. **Force Majeure.** Seller shall not be liable for any delay or failure in delivery resulting from causes beyond its control, including earthquakes, fires, floods, strikes or other labor disputes, shortage of labor or materials, accidents to machinery, acts of sabotage, riots, delay in or lack of transportation or the requirements of any government authority.
10. **Shipping; Delivery.** Unless otherwise expressly agreed in writing by Seller:
 - a. Shipments shall be by a carrier selected by Seller;
 - b. Such carrier shall act as the agent of Buyer and delivery to such carrier shall constitute delivery to Buyer;
 - c. All sales and shipments of Goods shall be FOB shipping point (unless otherwise stated in writing by Seller), at which point title to and all risk of loss of the Goods shall pass from Seller to Buyer, provided that Seller shall retain a security interest in the Goods until the full purchase price is paid by Buyer;
 - d. Delivery and shipping dates are estimates only.
 - e. Seller will package Goods as it deems proper for protection against normal handling and extra charges apply to special conditions.
11. **Claims.** Any claim by Buyer against Seller for shortage or damage to the Goods occurring before delivery to the carrier must be presented in writing to Seller within 30 days of receipt of shipment and include the original transportation bill signed by the carrier noting that the carrier received the Goods from Seller in the condition claimed.
12. **Warranties.** (a) **Exclusive Warranty.** Seller's exclusive warranty is that the Goods will be free from defects in materials and workmanship for a period of twelve months from the date of sale by Seller (or such other period expressed in writing by Seller). Seller disclaims all other warranties, express or implied. (b) **Limitations.** SELLER MAKES NO WARRANTY OR REPRESENTATION, EXPRESS OR IMPLIED, ABOUT NON-INFRINGEMENT, MERCHANTABILITY OR FITNESS FOR A PARTICULAR PURPOSE OF THE GOODS. BUYER ACKNOWLEDGES THAT IT ALONE HAS DETERMINED THAT THE GOODS WILL SUITABLY MEET THE REQUIREMENTS OF THEIR INTENDED USE. Seller further disclaims all warranties and responsibility of any type for claims or expenses based on infringement by the Goods or otherwise of any intellectual property right. (c) **Buyer Remedy.** Seller's sole obligation hereunder shall be to replace (in the form originally shipped with Buyer responsible for labor charges for removal or replacement thereof) the non-complying Good or, at Seller's election, to repay or credit Buyer an amount equal to the purchase price of the Good; provided that in no event shall Seller be responsible for warranty, repair, indemnity or any other claims or expenses regarding the Goods unless Seller's analysis confirms that the Goods were properly handled, stored, installed and maintained and not subject to contamination, abuse, misuse or inappropriate modification. Return of any goods by Buyer must be approved in writing by Seller before shipment. Seller shall not be liable for the suitability or unsuitability or the results from the use of Goods in combination with any electrical or electronic components, circuits, system assemblies or any other materials or substances or environments. Any advice, recommendations or information given orally or in writing, are not to be construed as an amendment or addition to the above warranty.
13. **Damage Limits; Etc.** SELLER SHALL NOT BE LIABLE FOR SPECIAL, INDIRECT OR CONSEQUENTIAL DAMAGES, LOSS OF PROFITS OR PRODUCTION OR COMMERCIAL LOSS IN ANY WAY CONNECTED WITH THE GOODS, WHETHER SUCH CLAIM IS BASED IN CONTRACT, WARRANTY, NEGLIGENCE OR STRICT LIABILITY. Further, in no event shall liability of Seller exceed the individual price of the Good on which liability is asserted.
14. **Indemnities.** Buyer shall indemnify and hold harmless Seller, its affiliates and its employees from and against all liabilities, losses, claims, costs and expenses (including attorney's fees and expenses) related to any claim, investigation, litigation or proceeding (whether or not Seller is a party) which arises or is alleged to arise from Buyer's acts or omissions under these Terms or in any way with respect to the Goods. Without limiting the foregoing, Buyer (at its own expense) shall indemnify and hold harmless Seller and defend or settle any action brought against Seller to the extent that it is based on a claim that any Good made to Buyer specifications infringed intellectual property rights of another party.
15. **Property; Confidentiality.** The intellectual property embodied in the Goods is the exclusive property of Seller and its affiliates and Buyer shall not attempt to duplicate it in any way without the written permission of Seller. Notwithstanding any charges to Buyer for engineering or tooling, all engineering and tooling shall remain the exclusive property of Seller. All information and materials supplied by Seller to Buyer relating to the Goods are confidential and proprietary, and Buyer shall limit distribution thereof to its trusted employees and strictly prevent disclosure to any third party.
16. **Miscellaneous.** (a) **Waiver.** No failure or delay by Seller in exercising any right and no course of dealing between Buyer and Seller shall operate as a waiver of rights by Seller. (b) **Assignment.** Buyer may not assign its rights hereunder without Seller's written consent. (c) **Amendment.** These Terms constitute the entire agreement between Buyer and Seller relating to the Goods, and no provision may be changed or waived unless in writing signed by the parties. (d) **Severability.** If any provision hereof is rendered ineffective or invalid, such provision shall not invalidate any other provision. (e) **Setoff.** Buyer shall have no right to set off any amounts against the amount owing in respect of this invoice. (f) As used herein, "including" means "including without limitation".

Certain Precautions on Specifications and Use

1. **Suitability of Use.** Seller shall not be responsible for conformity with any standards, codes or regulations which apply to the combination of the Good in the Buyer's application or use of the Good. At Buyer's request, Seller will provide applicable third party certification documents identifying ratings and limitations of use which apply to the Good. This information by itself is not sufficient for a complete determination of the suitability of the Good in combination with the end product, machine, system, or other application or use. The following are some examples of applications for which particular attention must be given. This is not intended to be an exhaustive list of all possible uses of this Good, nor is it intended to imply that the uses listed may be suitable for this Good:
 - (i) Outdoor use, uses involving potential chemical contamination or electrical interference, or conditions or uses not described in this document.
 - (ii) Energy control systems, combustion systems, railroad systems, aviation systems, medical equipment, amusement machines, vehicles, safety equipment, and installations subject to separate industry or government regulations.
 - (iii) Systems, machines and equipment that could present a risk to life or property. Please know and observe all prohibitions of use applicable to this Good.
2. **Programmable Products.** Seller shall not be responsible for the user's programming of a programmable Good, or any consequence thereof.
3. **Performance Data.** Performance data given in this catalog is provided as a guide for the user in determining suitability and does not constitute a warranty. It may represent the result of Seller's test conditions, and the user must correlate it to actual application requirements. Actual performance is subject to the Seller's Warranty and Limitations of Liability.
4. **Change in Specifications.** Product specifications and accessories may be changed at any time based on improvements and other reasons. It is our practice to change part numbers when published ratings or features are changed, or when significant construction changes are made. However, some specifications of the Good may be changed without any notice. When in doubt, special part numbers may be assigned to fix or establish key specifications for your application. Please consult with your Seller's representative at any time to confirm actual specifications of purchased Good.
5. **Errors and Omissions.** The information in this catalog has been carefully checked and is believed to be accurate; however, no responsibility is assumed for clerical, typographical or proofreading errors, or omissions.

NEVER USE THE PRODUCT FOR AN APPLICATION INVOLVING SERIOUS RISK TO LIFE OR PROPERTY WITHOUT ENSURING THAT THE SYSTEM AS A WHOLE HAS BEEN DESIGNED TO ADDRESS THE RISKS, AND THAT THE SELLER'S PRODUCT IS PROPERLY RATED AND INSTALLED FOR THE INTENDED USE WITHIN THE OVERALL EQUIPMENT OR SYSTEM.

Complete "Terms and Conditions of Sale" for product purchase and use are on Omron's website at www.omron.com/oei – under the "About Us" tab, in the Legal Matters section.

ALL DIMENSIONS SHOWN ARE IN MILLIMETERS.

To convert millimeters into inches, multiply by 0.03937. To convert grams into ounces, multiply by 0.03527.

OMRON[®]**OMRON ELECTRONICS LLC**

One Commerce Drive
Schaumburg, IL 60173

847-843-7900

For US technical support or other inquiries:

800-556-6766**OMRON CANADA, INC.**

885 Milner Avenue
Toronto, Ontario M1B 5V8

416-286-6465**OMRON ON-LINE**

Global - <http://www.omron.com>
USA - <http://www.omron.com/oei>
Canada - <http://www.omron.ca>