

Part Number:

254-PB206-ROX

Piezoelectric Buzzer Element

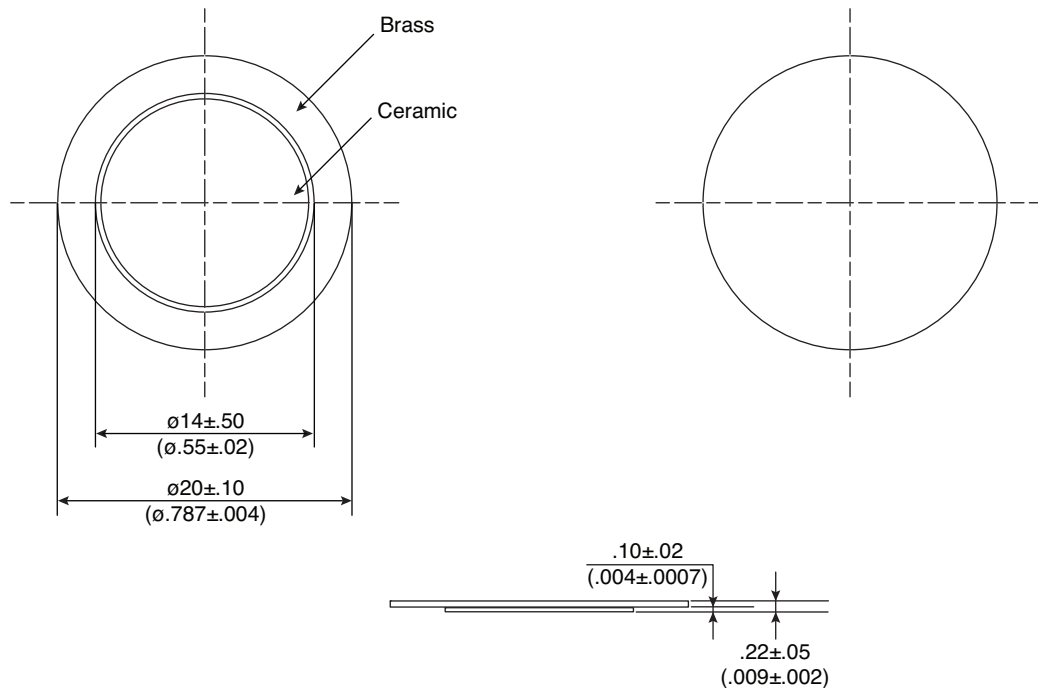

KT-400451

Electrical Specifications:

- Resonant Frequency: 3.6K Hz \pm 0.6
- Resonant Impedance: 500 Ω (max.)
- Capacity: 20,000pf \pm 30%

Note:

- RoHS Compliant by exemption

Mechanical Specifications:

- Type: External drive
- Operating Temperature: -20°C ~ +60°C
- Storage Temperature: -20°C ~ +70°C