

Part Number:

254-EMB105-RO

Magnetic Buzzer

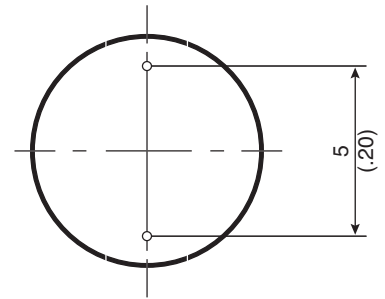
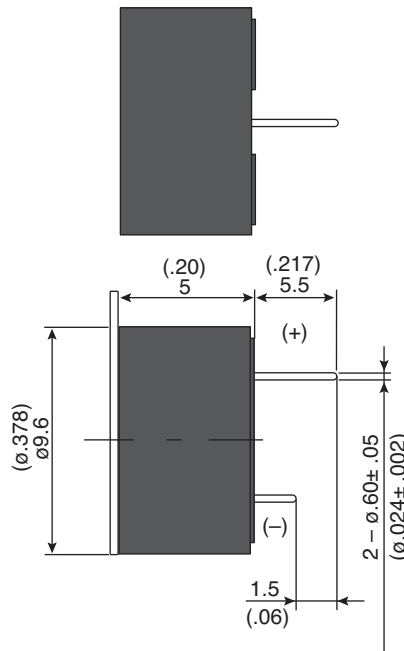
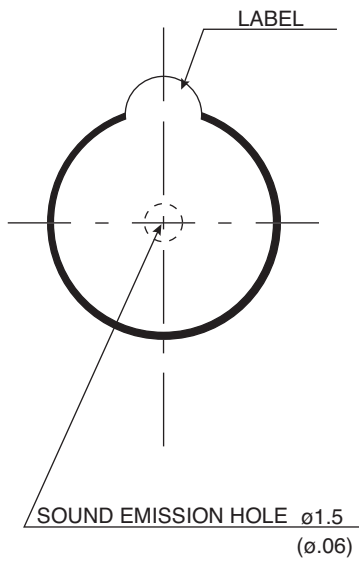

KT-400386

Electrical Specifications:

- Rated Voltage: 5VDC
- Operating Voltage: 3 ~ 7VDC
- Consumption Current: Mean 25mA(Max) Peak 75mA(Min)
- Sound Output: 80dBA(Min)
- Basic Frequency: 2500Hz \pm 200

Mechanical Specifications:

- Operating Temperature: -30°C ~ +75°C
- Storage Temperature: -40°C ~ +85°C

Note:

- RoHS Compliant