

# IEEE 1394 Firewire, 4 Pin Receptacle Right Angle SMT Type

154-AVR40-E



IEEE 1394 Firewire, 4 Pin Receptacle Right Angle SMT Type

Dimensions: mm (in.)

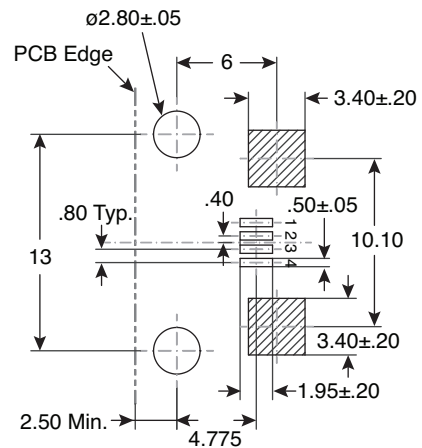
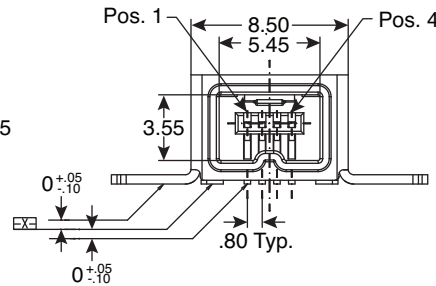
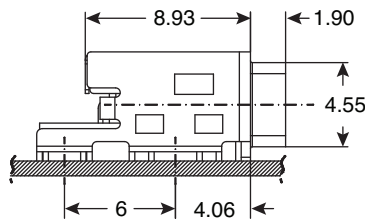
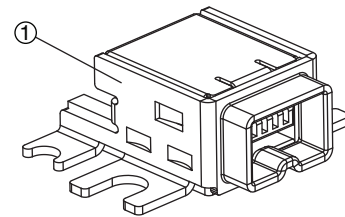
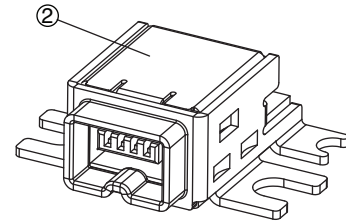
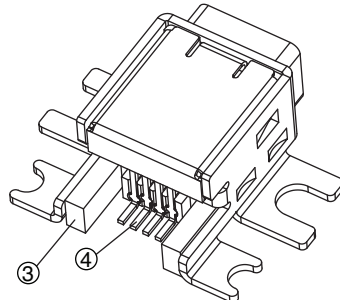
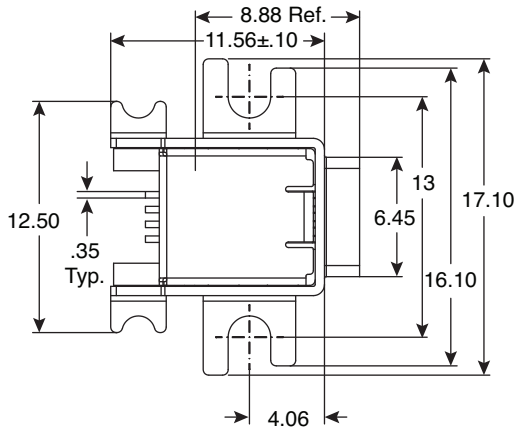

Recommended Surface-Mount Footprint

## Notes

<b>Withstanding Voltage:</b>	DC 500 ±50V
<b>Insulation Resistance:</b>	100 Megohms min.
<b>Contact Resistance:</b>	30 Milliohms max.
<b>Recommended PC Board Thickness:</b>	.80mm

## SPECIFICATIONS

Item	Part Name	Qty.	Material/Finish
4	Contacts	4	JIS C5191R-H/Selective Gold Plating (Refer to Table A)
3	Housing	1	PA-61/High-Temperature Thermoplastic Glass Filled, 240, 94V-0 Rated
2	Spring	1	Stainless
1	Shell	1	Stell (SPC-3)/Refer to Table A

RoHS Compliant

Date Last Revised: 7-21-09

Available from Mouser Electronics  
1-800-346-6873 / [www.mouser.com](http://www.mouser.com)

KC-301009

Specifications are subject to change without notice. No liability or warranty implied by this information. Environmental compliance based on producer documentation.

154-AVR40-E