

Alle Rechte vorbehalten/ All rights reserved

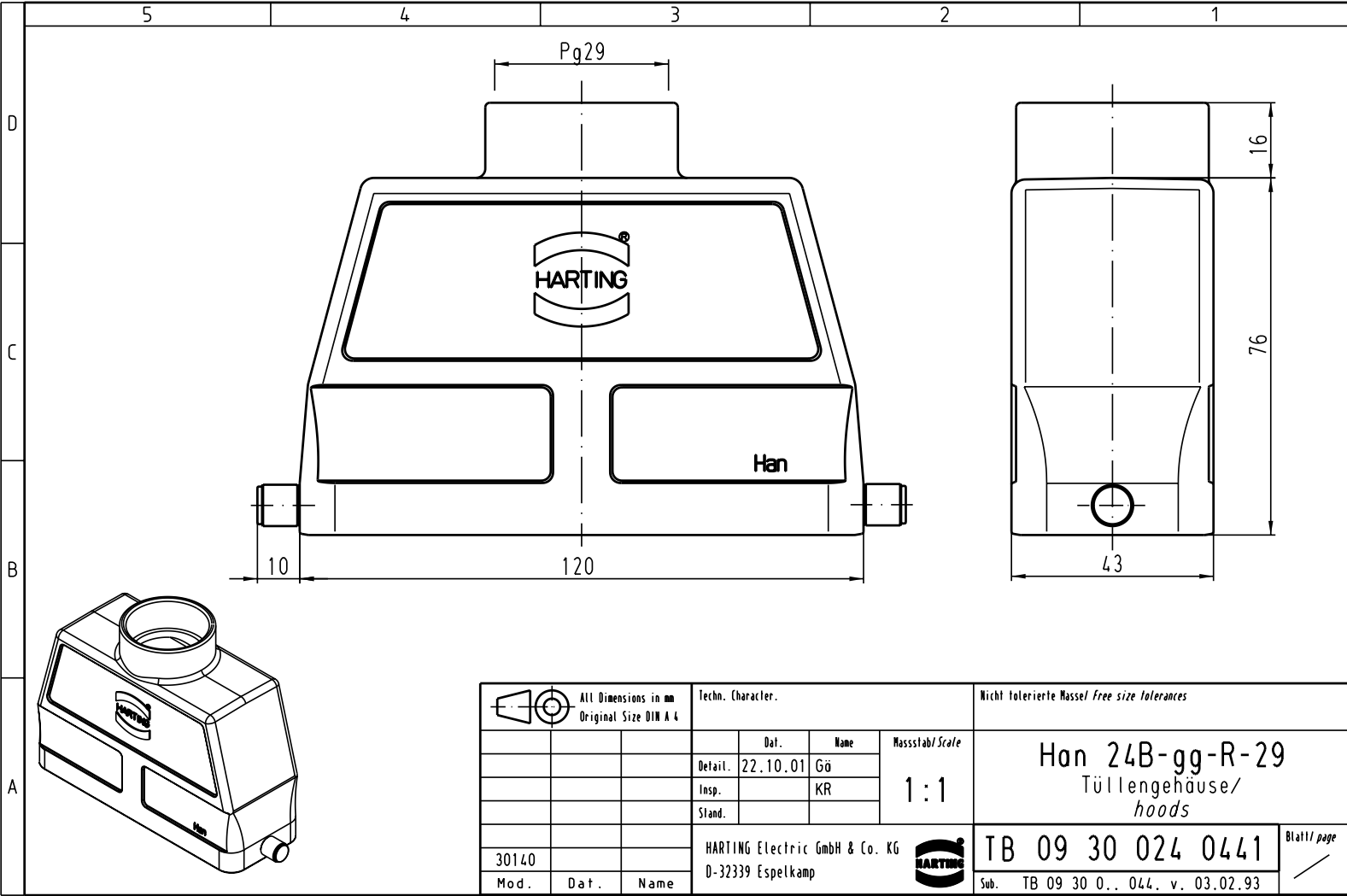

All Dimensions in mm Original Size DIN A 4		Techn. Character.			Nicht tolerierte Masse/ Free size tolerances		
			Dat.	Name	Massestab/Scale 1:1	Han 24B-gg-R-29 Tüllengehäuse/ hoods	
			Detail.	22.10.01			Gü
			Insp.				KR
			Stand.				
30140			HARTING Electric GmbH & Co. KG			TB 09 30 024 0441 Sub. TB 09 30 0.. 044. v. 03.02.93	
Mod.	Dat.	Name	D-32339 Espelkamp				
						Blatt/ page	