

# 2.5mm Pitch Connector for Discrete Wire Connection

## DF1 Series

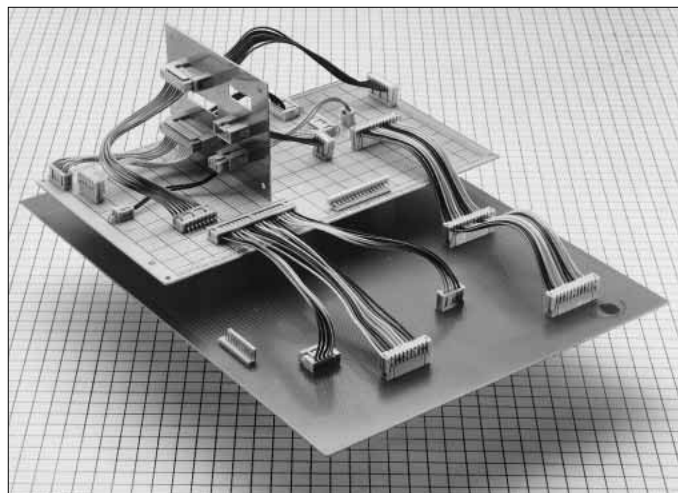

### ■ Features

#### 1. Board Mounting Height (Crimping Type)

**10mm** 2.5mm pitch connector achieves the low profile.

#### 2. Insulation Displacement Area Protected by Protector (ID Type)

The connector is structured to protect the insulation displacement connection area by the protector. Therefore, the connector has a strong tensile strength against the cable and prevents dusts.

#### 3. Easy Connection by Easy Tool (ID Type)

No expensive insulation displacement machine is needed. The connection can be established only by mating the cable into the protector and fastening it with the ID tool.

#### 4. Intermediate Connection Possible (ID Type)

For intermediate connection, the connector allows signal extraction during cabling.

### [Intermediate Connection]

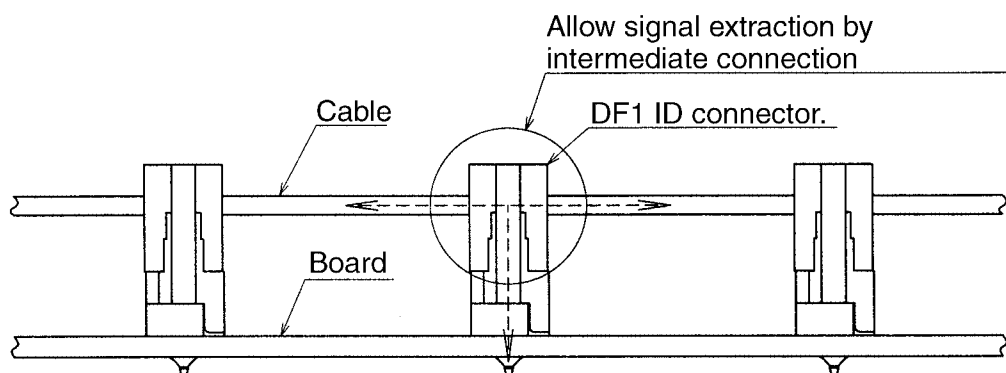

### ■ Applications

FA equipment, measurement equipment

## Product Specifications

|        |                           |            |   |                             |                      |
|--------|---------------------------|------------|---|-----------------------------|----------------------|
| Rating | Current rating<br>(Note1) | Cable Size | AWG 24 : 3A<br>AWG 26 : 2A<br>AWG 28 : 1A | Operating Temperature Range | -30 to +85°C (Note2) |
|        | Voltage rating            | 250V AC    |   | Operating Moisture Range    | 40 to 80%            |
|        |                           |            |   | Storage Temperature Range   | -10 to +60°C (Note3) |
|        |                           |            |   | Storage Moisture Range      | 40 to 70% (Note3)    |

| Item                             | Specification  | Condition   |
|----------------------------------|--|---|
| 1. Insulation Resistance         | 1000M ohms Min   | 500V DC   |
| 2. Withstanding voltage          | No flashover or insulation breakdown.                                    | 650V AC/1 minute  |
| 3. Contact Resistance            | 30m ohms Max   | 100mA   |
| 4. Insertor/Extraction Force     | MIN0.56N (57gf), MAX4.4N(450gf)  | Measure by the square steel pin with 0.635±0.002mm  |
| 5. Vibration                     | No electrical discontinuity of 1μs or more                               | Frequency: 10 to 55 Hz, single amplitude of 0.75 mm, 2 hours in each of the 3 directions. |
| 6. Moisture Resistance           | Contact resistance: 30m ohms Max Insulation resistance: 1000M ohms Min   | 96 hours at temperature of 40°C and humidity of 90% to 95%                                |
| 7. Temperature Cycle             | Contact resistance: 30m ohms max. Insulation resistance: 1000M ohms min. | (-55°C: 30 minutes → 5~35°C: 10 minutes → 85°C: 30 minutes → 5~35°C: 10 minutes) 5 cycles |
| 8. Durability (Mating/un-mating) | Contact resistance: 30m ohms max.  | Tin plating: 30 cycles  |
| 9. Resistance to Soldering heat  | No deformation of components affecting performance.                      | Flow: 250°C for 10 seconds<br>Manual soldering: 300°C for 3 seconds                       |

Note 1: The rated current will be changed according to cable sizes for use. For the header only, the rating is 3A.

Note 2: Includes temperature rise caused by current flow.

Note 3: The term "storage" refers to products stored for long period of time prior to mounting and use. Operating Temperature Range and Humidity range covers non conducting condition of installed connectors in storage, shipment or during transportation.

Note 4: Information contained in this catalog represents general requirements for this Series. Contact us for the drawings and specifications for a specific part number shown.

## Material

| Product          | Part      | Material        | Finish      | Remarks |
|------------------|-----------|-----------------|-------------|---------|
| Crimping Socket  | Insulator | Polyamide       | Light Brown | UL94V-0 |
| Crimping Contact | Contact   | Phosphor copper | Tin plated  | —       |
| ID Socket        | Insulator | Polyamide       | Light Brown | UL94V-0 |
|                  | Contact   | Phosphor copper | Tin plated  | —       |
| Pin Header       | Insulator | Polyamide       | Light Brown | UL94V-0 |
|                  | Contact   | Phosphor copper | Tin plated  | —       |

Note: Hirose's tin-plated products takes measures against whisker.

## Ordering Information

### Connector

**DF1** - \* **S** - **2.5** **C**  
①      ②   ③      ④   ⑤

|  |  |
|--|--|
| ① Series Name : DF1                            | ⑤ Contact Type<br>C : Crimping socket<br>R24 : AWG24 ID socket<br>R26 : AWG26 ID socket<br>R28 : AWG28 ID socket<br>DSA : Straight through hole<br>DS : Right angle through hole |
| ② Number of Contact : 2 to 16, 20              |  |
| ③ Connector Type<br>S: Socket<br>P: Pin Header |  |
| ④ Contact Pitch : 2.5mm                        |  |

### Protector

**DF1** - \* **A** **1.05**  
①      ②      ③

|                                      |  |
|--------------------------------------|--|
| ① Number of Contact : 2 to 16, 20    | ③ Cable Clamp Size<br>1.05: UL1007 AWG26, 28<br>1.33: UL1007 AWG24 |
| ② Connector Type<br>A: Discrete wire |  |

### Contact

**DF1** - **2428SCF**  
①      ②

|   |  |
|---|--|
| ① Applicable Cable Size<br>2428: AWG 24 to 28 | ② Packaging Type<br>SCF : Socket contact, reel packaging / Tin plated<br>SC : Socket contact, bag packaging / Tin plated |
|---|--|

**DF1 Series 2.5mm Pitch Connector for Discrete Wire Connection**

**ID Socket (Open End Type)**

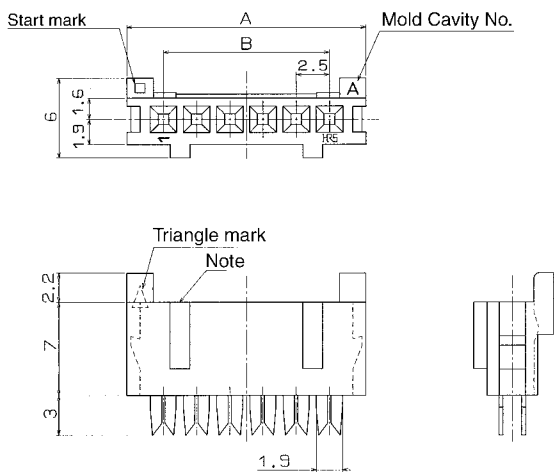

**●Applicable Cable**

| Part Number       | Applicable Cable                | Jacket Diameter |
|-------------------|---------------------------------|-----------------|
| DF1-*S-2.5R24(05) | UL1007 AWG24(11 pieces/0.16mm)  | 1.35 to 1.45mm  |
| DF1-*S-2.5R26(05) | UL1007 AWG26( 7 pieces/0.16mm)  | 1.25 to 1.35mm  |
| DF1-*S-2.5R28(05) | UL1007 AWG28( 7 pieces/0.127mm) | 1.15 to 1.25mm  |

(Tin plated annealing copper wire)

Note: This convex portion is located (2 contacts: the center at one point)(3 to 6 contacts: as shown in the illustration)(more than 7 contacts: one center at one point added to the above illustration).

**●AWG24 Cable Socket Size (Triangle Mark: Green)**

Unit: mm

| Part Number       | CL No.        | Number of Contacts | A    | B    | RoHS | Part Number        | CL No.        | Number of Contacts | A    | B    | RoHS |
|-------------------|---------------|--------------------|------|------|------|--------------------|---------------|--------------------|------|------|------|
| DF1-2S-2.5R24(05) | 541-0039-2-05 | 2                  | 8    | 2.5  | Yes  | DF1-10S-2.5R24(05) | 541-0047-0-05 | 10                 | 28   | 22.5 | Yes  |
| DF1-3S-2.5R24(05) | 541-0040-1-05 | 3                  | 10.5 | 5    |      | DF1-11S-2.5R24(05) | 541-0048-3-05 | 11                 | 30.5 | 25   |      |
| DF1-4S-2.5R24(05) | 541-0041-4-05 | 4                  | 13   | 7.5  |      | DF1-12S-2.5R24(05) | 541-0049-6-05 | 12                 | 33   | 27.5 |      |
| DF1-5S-2.5R24(05) | 541-0042-7-05 | 5                  | 15.5 | 10   |      | DF1-13S-2.5R24(05) | 541-0050-5-05 | 13                 | 35.5 | 30   |      |
| DF1-6S-2.5R24(05) | 541-0043-0-05 | 6                  | 18   | 12.5 |      | DF1-14S-2.5R24(05) | 541-0051-8-05 | 14                 | 38   | 32.5 |      |
| DF1-7S-2.5R24(05) | 541-0044-2-05 | 7                  | 20.5 | 15   |      | DF1-15S-2.5R24(05) | 541-0052-0-05 | 15                 | 40.5 | 35   |      |
| DF1-8S-2.5R24(05) | 541-0045-5-05 | 8                  | 23   | 17.5 |      | DF1-16S-2.5R24(05) | 541-0053-3-05 | 16                 | 43   | 37.5 |      |
| DF1-9S-2.5R24(05) | 541-0046-8-05 | 9                  | 25.5 | 20   |      | DF1-20S-2.5R24(05) | 541-0057-4-05 | 20                 | 53   | 47.5 |      |

**●AWG26 Cable Socket Size (Triangle Mark: Light Blue)**

Unit: mm

| Part Number       | CL No.        | Number of Contacts | A    | B    | RoHS | Part Number        | CL No.        | Number of Contacts | A    | B    | RoHS |
|-------------------|---------------|--------------------|------|------|------|--------------------|---------------|--------------------|------|------|------|
| DF1-2S-2.5R26(05) | 541-0058-7-05 | 2                  | 8    | 2.5  | Yes  | DF1-10S-2.5R26(05) | 541-0066-5-05 | 10                 | 28   | 22.5 | Yes  |
| DF1-3S-2.5R26(05) | 541-0059-0-05 | 3                  | 10.5 | 5    |      | DF1-11S-2.5R26(05) | 541-0067-8-05 | 11                 | 30.5 | 25   |      |
| DF1-4S-2.5R26(05) | 541-0060-9-05 | 4                  | 13   | 7.5  |      | DF1-12S-2.5R26(05) | 541-0068-0-05 | 12                 | 33   | 27.5 |      |
| DF1-5S-2.5R26(05) | 541-0061-1-05 | 5                  | 15.5 | 10   |      | DF1-13S-2.5R26(05) | 541-0069-3-05 | 13                 | 35.5 | 30   |      |
| DF1-6S-2.5R26(05) | 541-0062-4-05 | 6                  | 18   | 12.5 |      | DF1-14S-2.5R26(05) | 541-0070-2-05 | 14                 | 38   | 32.5 |      |
| DF1-7S-2.5R26(05) | 541-0063-7-05 | 7                  | 20.5 | 15   |      | DF1-15S-2.5R26(05) | 541-0071-5-05 | 15                 | 40.5 | 35   |      |
| DF1-8S-2.5R26(05) | 541-0064-0-05 | 8                  | 23   | 17.5 |      | DF1-16S-2.5R26(05) | 541-0072-8-05 | 16                 | 43   | 37.5 |      |
| DF1-9S-2.5R26(05) | 541-0065-2-05 | 9                  | 25.5 | 20   |      | DF1-20S-2.5R26(05) | 541-0076-9-05 | 20                 | 53   | 47.5 |      |

**●AWG28 Cable Socket Size (Triangle Mark: Red)**

Unit: mm

| Part Number       | CL No.        | Number of Contacts | A    | B    | RoHS | Part Number        | CL No.        | Number of Contacts | A    | B    | RoHS |
|-------------------|---------------|--------------------|------|------|------|--------------------|---------------|--------------------|------|------|------|
| DF1-2S-2.5R28(05) | 541-0115-9-05 | 2                  | 8    | 2.5  | Yes  | DF1-10S-2.5R28(05) | 541-0123-7-05 | 10                 | 28   | 22.5 | Yes  |
| DF1-3S-2.5R28(05) | 541-0116-1-05 | 3                  | 10.5 | 5    |      | DF1-11S-2.5R28(05) | 541-0124-0-05 | 11                 | 30.5 | 25   |      |
| DF1-4S-2.5R28(05) | 541-0117-4-05 | 4                  | 13   | 7.5  |      | DF1-12S-2.5R28(05) | 541-0125-2-05 | 12                 | 33   | 27.5 |      |
| DF1-5S-2.5R28(05) | 541-0118-7-05 | 5                  | 15.5 | 10   |      | DF1-13S-2.5R28(05) | 541-0126-5-05 | 13                 | 35.5 | 30   |      |
| DF1-6S-2.5R28(05) | 541-0119-0-05 | 6                  | 18   | 12.5 |      | DF1-14S-2.5R28(05) | 541-0127-8-05 | 14                 | 38   | 32.5 |      |
| DF1-7S-2.5R28(05) | 541-0120-9-05 | 7                  | 20.5 | 15   |      | DF1-15S-2.5R28(05) | 541-0128-0-05 | 15                 | 40.5 | 35   |      |
| DF1-8S-2.5R28(05) | 541-0121-1-05 | 8                  | 23   | 17.5 |      | DF1-16S-2.5R28(05) | 541-0129-3-05 | 16                 | 43   | 37.5 |      |
| DF1-9S-2.5R28(05) | 541-0122-4-05 | 9                  | 25.5 | 20   |      | DF1-20S-2.5R28(05) | 531-0133-0-05 | 20                 | 53   | 47.5 |      |

Note: A packaging quantity is delivered by the bag unit (100 pcs.). If needed, please order the products per bag.

## Protector

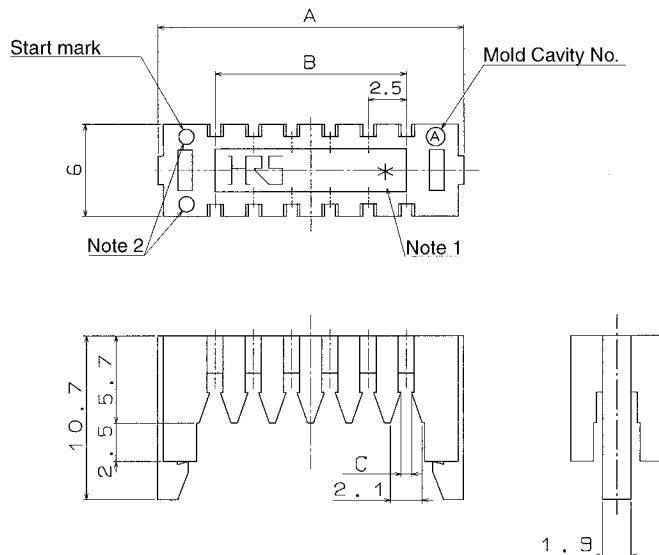
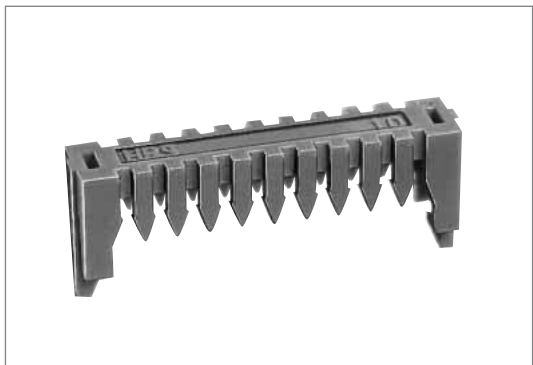

Note 1. Product contact No. mark, however 2 and 3 contacts are not indicated.  
 Note 2. Round hole to distinguish the protector A1.05 and 1.33 (DF1-\*A1.05 only)

Select the protector after inspecting the cable jacket diameter for use.

| Protector Type | Applicable Jacket Diameter | Recommended Cable |
|----------------|----------------------------|-------------------|
| DF1-*A1.33     | $\phi 1.35$ to $\phi 1.45$ | UL1007 AWG24      |
| DF1-*A1.05     | $\phi 1.1$ to $\phi 1.35$  | UL1007 AWG26 28   |

\*indicates contact No.

### ●AWG24 Cable Protector Size

Unit: mm

| Part Number | CL No.     | Number of Contacts | A    | B    | C   | RoHS |
|-------------|------------|--------------------|------|------|-----|------|
| DF1- 2A1.33 | 541-0077-1 | 2                  | 10   | 2.5  | 1.1 | Yes  |
| DF1- 3A1.33 | 541-0078-4 | 3                  | 12.5 | 5    | 1.1 |      |
| DF1- 4A1.33 | 541-0079-7 | 4                  | 15   | 7.5  | 1.1 |      |
| DF1- 5A1.33 | 541-0080-6 | 5                  | 17.5 | 10   | 1.1 |      |
| DF1- 6A1.33 | 541-0081-9 | 6                  | 20   | 12.5 | 1.1 |      |
| DF1- 7A1.33 | 541-0082-1 | 7                  | 22.5 | 15   | 1.1 |      |
| DF1- 8A1.33 | 541-0083-4 | 8                  | 25   | 17.5 | 1.1 |      |
| DF1- 9A1.33 | 541-0084-7 | 9                  | 27.5 | 20   | 1.1 |      |
| DF1-10A1.33 | 541-0085-0 | 10                 | 30   | 22.5 | 1.1 |      |
| DF1-11A1.33 | 541-0086-2 | 11                 | 32.5 | 25   | 1.1 |      |
| DF1-12A1.33 | 541-0087-5 | 12                 | 35   | 27.5 | 1.1 |      |
| DF1-13A1.33 | 541-0088-8 | 13                 | 37.5 | 30   | 1.1 |      |
| DF1-14A1.33 | 541-0089-0 | 14                 | 40   | 32.5 | 1.1 |      |
| DF1-15A1.33 | 541-0090-0 | 15                 | 42.5 | 35   | 1.1 |      |
| DF1-16A1.33 | 541-0091-2 | 16                 | 45   | 37.5 | 1.1 |      |
| DF1-20A1.33 | 541-0095-3 | 20                 | 55   | 47.5 | 1.1 |      |

### ●AWG26, 28 Cable Protector Size

Unit: mm

| Part Number | CL No.     | Number of Contacts | A    | B    | C   | RoHS |
|-------------|------------|--------------------|------|------|-----|------|
| DF1- 2A1.05 | 541-0096-6 | 2                  | 10   | 2.5  | 0.7 | Yes  |
| DF1- 3A1.05 | 541-0097-9 | 3                  | 12.5 | 5    | 0.7 |      |
| DF1- 4A1.05 | 541-0098-1 | 4                  | 15   | 7.5  | 0.7 |      |
| DF1- 5A1.05 | 541-0099-4 | 5                  | 17.5 | 10   | 0.7 |      |
| DF1- 6A1.05 | 541-0100-1 | 6                  | 20   | 12.5 | 0.7 |      |
| DF1- 7A1.05 | 541-0101-4 | 7                  | 22.5 | 15   | 0.7 |      |
| DF1- 8A1.05 | 541-0102-7 | 8                  | 25   | 17.5 | 0.7 |      |
| DF1- 9A1.05 | 541-0103-0 | 9                  | 27.5 | 20   | 0.7 |      |
| DF1-10A1.05 | 541-0104-2 | 10                 | 30   | 22.5 | 0.7 |      |
| DF1-11A1.05 | 541-0105-5 | 11                 | 32.5 | 25   | 0.7 |      |
| DF1-12A1.05 | 541-0106-8 | 12                 | 35   | 27.5 | 0.7 |      |
| DF1-13A1.05 | 541-0107-0 | 13                 | 37.5 | 30   | 0.7 |      |
| DF1-14A1.05 | 541-0108-3 | 14                 | 40   | 32.5 | 0.7 |      |
| DF1-15A1.05 | 541-0109-6 | 15                 | 42.5 | 35   | 0.7 |      |
| DF1-16A1.05 | 541-0110-5 | 16                 | 45   | 37.5 | 0.7 |      |
| DF1-20A1.05 | 541-0114-6 | 20                 | 55   | 47.5 | 0.7 |      |

Note: A packaging quantity is delivered by the bag unit (100 pcs.). If needed, please order the product per bag.

## DF1 Series 2.5mm Pitch Connector for Discrete Wire Connection

### ■ Crimping Socket

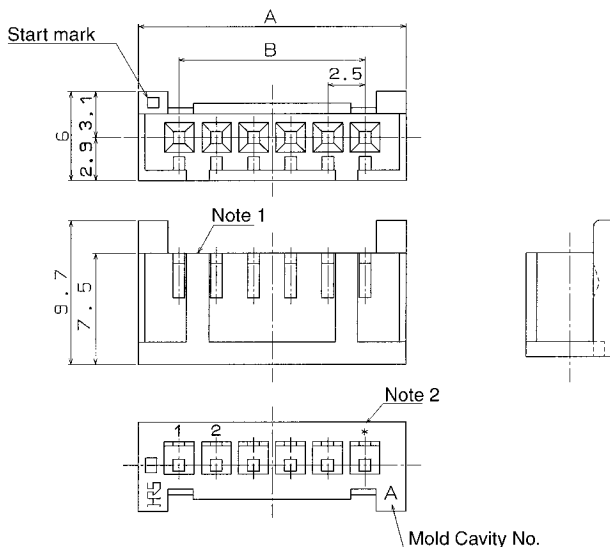
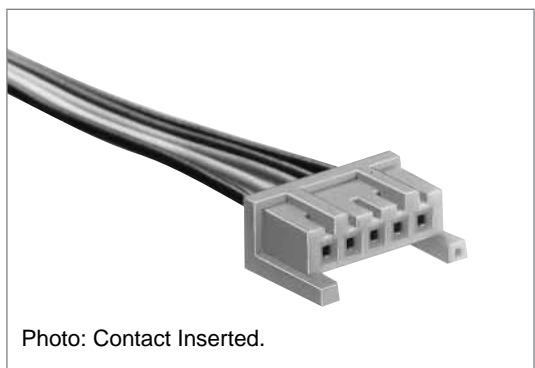

Note1: This convex portion is located (2 contacts: the center at one point)(3 to 6 contacts: as shown in the illustration)(more than 7 contacts: one center at one point added to the above illustration).  
 Note 2: The terminal number indicates all contact numbers.

Unit: mm

| Part Number  | CL No.     | Number of Contacts | A    | B    | RoHS | Part Number  | CL No.     | Number of Contacts | A    | B    | RoHS |
|--------------|------------|--------------------|------|------|------|--------------|------------|--------------------|------|------|------|
| DF1- 2S-2.5C | 541-0136-9 | 2                  | 8    | 2.5  | Yes  | DF1-11S-2.5C | 541-0145-0 | 11                 | 30.5 | 25   | Yes  |
| DF1- 3S-2.5C | 541-0137-1 | 3                  | 10.5 | 5    |      | DF1-12S-2.5C | 541-0146-2 | 12                 | 33   | 27.5 |      |
| DF1- 4S-2.5C | 541-0138-4 | 4                  | 13   | 7.5  |      | DF1-13S-2.5C | 541-0147-5 | 13                 | 33.5 | 30   |      |
| DF1- 5S-2.5C | 541-0139-7 | 5                  | 15.5 | 10   |      | DF1-14S-2.5C | 541-0148-8 | 14                 | 38   | 32.5 |      |
| DF1- 6S-2.5C | 541-0140-6 | 6                  | 18   | 12.5 |      | DF1-15S-2.5C | 541-0149-0 | 15                 | 40.5 | 35   |      |
| DF1- 7S-2.5C | 541-0141-9 | 7                  | 20.5 | 15   |      | DF1-16S-2.5C | 541-0150-0 | 16                 | 43   | 37.5 |      |
| DF1- 8S-2.5C | 541-0142-1 | 8                  | 23   | 17.5 |      | DF1-18S-2.5C | 541-0152-5 | 18                 | 48   | 42.5 |      |
| DF1- 9S-2.5C | 541-0143-4 | 9                  | 25.5 | 20   |      | DF1-20S-2.5C | 541-0154-0 | 20                 | 53   | 47.5 |      |
| DF1-10S-2.5C | 541-0144-7 | 10                 | 28   | 22.5 |      |              |            |                    |      |      |      |

Note: A packaging quantity is delivered by the bag unit (100 pcs.). If needed, please order the product per bag.

### ■ Crimping Contact for Socket

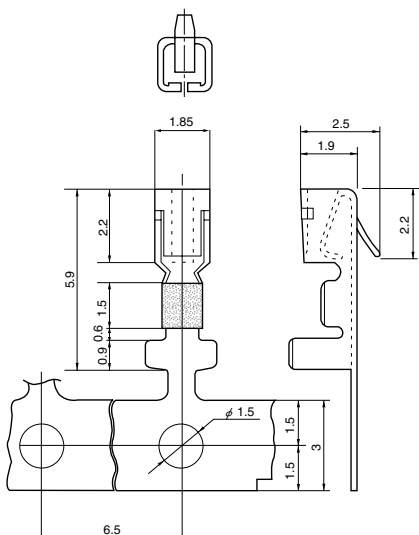

| Part Number | CL No.     | Packaging Type | Number of Contacts | Finish      | RoHS |
|-------------|------------|----------------|--------------------|-------------|------|
| DF1-2428SCF | 541-0134-3 | Reel           | 10000              | Tin plating | Yes  |
| DF1-2428SC  | 541-0135-6 | Bag            | 100                |             |      |

#### ● Applicable Cable (Tin Plated Annealing Copper Wire)

| Conductor Size (wire construction) | Jacket Diameter |
|------------------------------------|-----------------|
| AWG24 (11 cores/0.16mm)            | φ0.9 to φ1.5mm  |
| AWG26 ( 7 cores/0.16mm)            |                 |
| AWG28 (07 cores/1.24mm)            |                 |

Note: If other cables are used instead of the applicable cable, contact Hirose sales department.

#### ● Recommended Cable

UL1061, UL1007

#### ● Strip Length

1.9 to 2.4mm

#### ◆ Applicable Crimping Tool

| Type                 | Part Number  | CL No.     | Applicable Contact |
|----------------------|--|------------|--------------------|
| Applicator           | AP105-DF1-2428S                                    | 901-4538-8 | DF1-2428SCF        |
| Press Main Unit      | CM-105   | 901-0005-4 | _____              |
| Manual Crimping Tool | DF1-T2428S   | 550-0102-8 | DF1-2428SC         |
| Extraction Tool      | Flat-bladed screwdriver, 0.75 mm max, blade width. |            |                    |

Note 1: If a trouble has occurred due to tools which are not designated by Hirose, Hirose won't guarantee any product.

Note 2: Refer to technical specification for work method of extraction tool.

## Pin Header Right Angle Type



● Board Through-hole Diameter :  $\phi 1.1^{+0.1}$

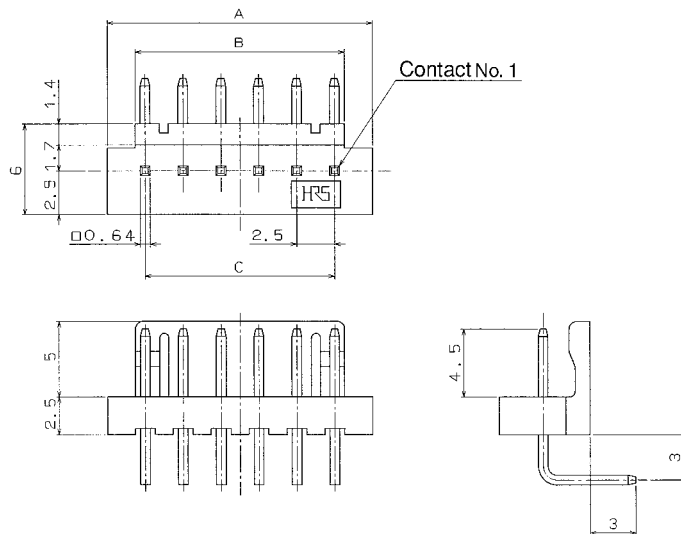

Unit: mm

| Part Number       | CL No.        | Number of Contacts | A    | B    | C    | RoHS | Part Number       | CL No.        | Number of Contacts | A    | B    | C    | RoHS |  |
|-------------------|---------------|--------------------|------|------|------|------|-------------------|---------------|--------------------|------|------|------|------|--|
| DF1- 2P-2.5DS(05) | 541-0020-4-05 | 2                  | 7.5  | 3.8  | 2.5  | Yes  | DF1-11P-2.5DS(05) | 541-0029-9-05 | 11                 | 30   | 26.3 | 25   | Yes  |  |
| DF1- 3P-2.5DS(05) | 541-0021-7-05 | 3                  | 10   | 6.3  | 5    |      | DF1-12P-2.5DS(05) | 541-0030-8-05 | 12                 | 32.5 | 28.8 | 27.5 |      |  |
| DF1- 4P-2.5DS(05) | 541-0022-0-05 | 4                  | 12.5 | 8.8  | 7.5  |      | DF1-13P-2.5DS(05) | 541-0031-0-05 | 13                 | 35   | 31.3 | 30   |      |  |
| DF1- 5P-2.5DS(05) | 541-0023-2-05 | 5                  | 15   | 11.3 | 10   |      | DF1-14P-2.5DS(05) | 541-0032-3-05 | 14                 | 37.5 | 33.8 | 32.5 |      |  |
| DF1- 6P-2.5DS(05) | 541-0024-5-05 | 6                  | 17.5 | 13.8 | 12.5 |      | DF1-15P-2.5DS(05) | 541-0033-6-05 | 15                 | 40   | 36.3 | 35   |      |  |
| DF1- 7P-2.5DS(05) | 541-0025-8-05 | 7                  | 20   | 16.3 | 15   |      | DF1-16P-2.5DS(05) | 541-0034-9-05 | 16                 | 42.5 | 38.8 | 37.5 |      |  |
| DF1- 8P-2.5DS(05) | 541-0026-0-05 | 8                  | 22.5 | 18.8 | 17.5 |      | DF1-18P-2.5DS(05) | 541-0036-4-05 | 18                 | 47.5 | 43.8 | 42.5 |      |  |
| DF1- 9P-2.5DS(05) | 541-0027-3-05 | 9                  | 25   | 21.3 | 20   |      | DF1-20P-2.5DS(05) | 541-0038-0-05 | 20                 | 52.5 | 48.8 | 47.5 |      |  |
| DF1-10P-2.5DS(05) | 541-0028-6-05 | 10                 | 27.5 | 23.8 | 22.5 |      |                   |               |                    |      |      |      |      |  |

Note 1. A packaging quantity is delivered by the bag unit (100 pcs.). If needed, please order the product per bag.

Note 2. The socket applicable to the 18 contact connector is only crimping type.

## Pin Header Straight Type

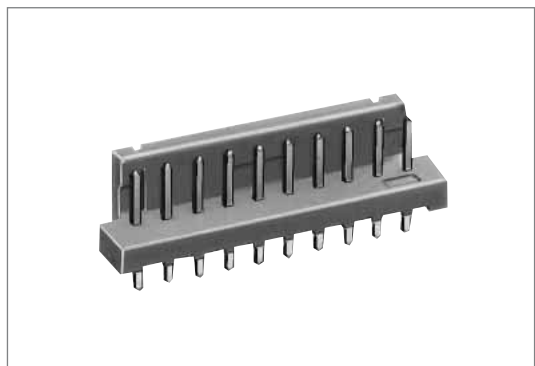

● Board Through-hole Diameter :  $\phi 1.1^{+0.1}$

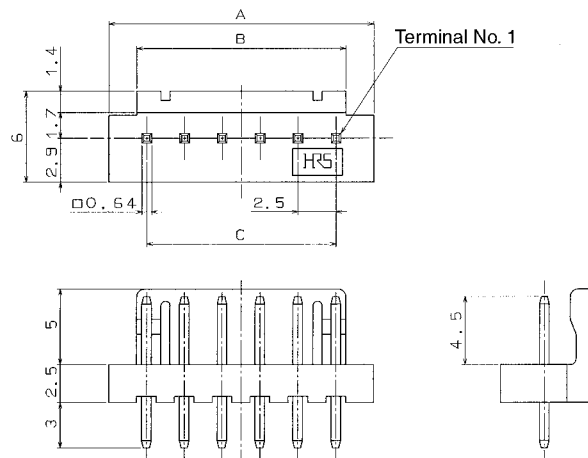

Unit: mm

| Part Number        | CL No.        | Number of Contacts | A    | B    | C    | RoHS | Part Number        | CL No.        | Number of Contacts | A    | B    | C    | RoHS |  |
|--------------------|---------------|--------------------|------|------|------|------|--------------------|---------------|--------------------|------|------|------|------|--|
| DF1- 2P-2.5DSA(05) | 541-0001-0-05 | 2                  | 7.5  | 3.8  | 2.5  | Yes  | DF1-11P-2.5DSA(05) | 541-0010-0-05 | 11                 | 30   | 26.3 | 25   | Yes  |  |
| DF1- 3P-2.5DSA(05) | 541-0002-2-05 | 3                  | 10   | 6.3  | 5    |      | DF1-12P-2.5DSA(05) | 541-0011-3-05 | 12                 | 32.5 | 28.8 | 27.5 |      |  |
| DF1- 4P-2.5DSA(05) | 541-0003-5-05 | 4                  | 12.5 | 8.8  | 7.5  |      | DF1-13P-2.5DSA(05) | 541-0012-6-05 | 13                 | 35   | 31.3 | 30   |      |  |
| DF1- 5P-2.5DSA(05) | 541-0004-8-05 | 5                  | 15   | 11.3 | 10   |      | DF1-14P-2.5DSA(05) | 541-0013-9-05 | 14                 | 37.5 | 33.8 | 32.5 |      |  |
| DF1- 6P-2.5DSA(05) | 541-0005-0-05 | 6                  | 17.5 | 13.8 | 12.5 |      | DF1-15P-2.5DSA(05) | 541-0014-1-05 | 15                 | 40   | 36.3 | 35   |      |  |
| DF1- 7P-2.5DSA(05) | 541-0006-3-05 | 7                  | 20   | 16.3 | 15   |      | DF1-16P-2.5DSA(05) | 541-0015-4-05 | 16                 | 42.5 | 38.8 | 37.5 |      |  |
| DF1- 8P-2.5DSA(05) | 541-0007-6-05 | 8                  | 22.5 | 18.8 | 17.5 |      | DF1-18P-2.5DSA(05) | 541-0017-0-05 | 18                 | 47.5 | 43.8 | 42.5 |      |  |
| DF1- 9P-2.5DSA(05) | 541-0008-9-05 | 9                  | 25   | 21.3 | 20   |      | DF1-20P-2.5DSA(05) | 541-0019-5-05 | 20                 | 52.5 | 48.8 | 47.5 |      |  |
| DF1-10P-2.5DSA(05) | 541-0009-1-05 | 10                 | 27.5 | 23.8 | 22.5 |      |                    |               |                    |      |      |      |      |  |

Note 1. A packaging quantity is delivered by the bag unit (100 pcs.). If needed, please order the product per bag.

Note 2. The socket applicable to the 18 contacts connector is only crimping type.

## DF1 Series 2.5mm Pitch Connector for Discrete Wire Connection

### ◆DF1 Connection Press

| Part Number                | CL No.     | Height | Width | Depth | Weight |
|----------------------------|------------|--------|-------|-------|--------|
| DF1 Connection Press HP513 | 550-0134-4 | 200mm  | 260mm | 250mm | 3.7kg  |

**Note:**The intermediate connection can be established by removing the cable cutting blade of this press machine.  
 Select a protector after inspecting a cable Jacket diameter for use.

| Protector Type      | Applicable Jacket Diameter | Recommended Cable |
|---------------------|----------------------------|-------------------|
| DF1- <b>*</b> A1.33 | φ1.35 to φ1.45             | UL1007 AWG24      |
| DF1- <b>*</b> A1.05 | φ1.1 to φ1.35              | UL1007 AWG26, 28  |

\* indicates contact No.

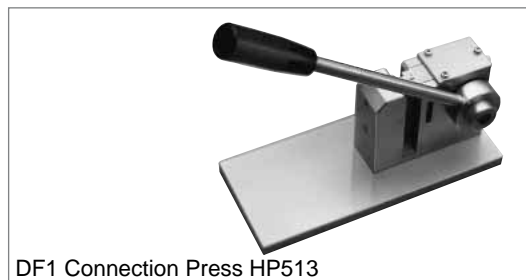

DF1 Connection Press HP513



DF1 Cable Crimper

### ◆DF1 Cable Crimper

| Part Number       | CL No.     |
|-------------------|------------|
| DF1 Cable Crimper | 550-0130-3 |

Used to install the cable in the protector.

### ◆Precautions

|                                    |  |
|------------------------------------|--|
| 1. Recommended Soldering Condition | Flow: 250°C for 10 seconds<br>Manual soldering: 300°C for 3 seconds  |
| 2. Cleaning Condition              | Refer to Nylon Connector Use Hand book.  |
| 3. Connection Condition            | [Crimping]<br>Refer to Nylon Connector Use Hand book.<br>[ID]<br>●For the insulation displacement tool, set a set of connector per insulation displacement. If more than 2 connectors have been set, they interrupt each other, which will cause an insulation displacement failure.<br>●After the insulation displacement, make sure that the locks on both protector sides are completely activated. |
| 4. Precaution                      | Slight variations in color of the plastic compounds do not affect form, fit or function of the connector.  |
| 5. Precaution                      | Refer to Nylon Connector Use Hand book.  |