



Plastic Hoods FKH, Straight Cable Outlet

Kunststoffhauben FKH, gerader Kabelausgang



Plastic hoods, series FKH, in shell sizes 1 - 5.

Kunststoffhauben der Serie FKH in den Gehäusegrößen 1 - 5



Shielded plastic hoods, series FKH...A, in shell sizes 1 - 5.

Abgeschirmte Kunststoffhauben der Serie FKH...A in den Gehäusegrößen 1 - 5.

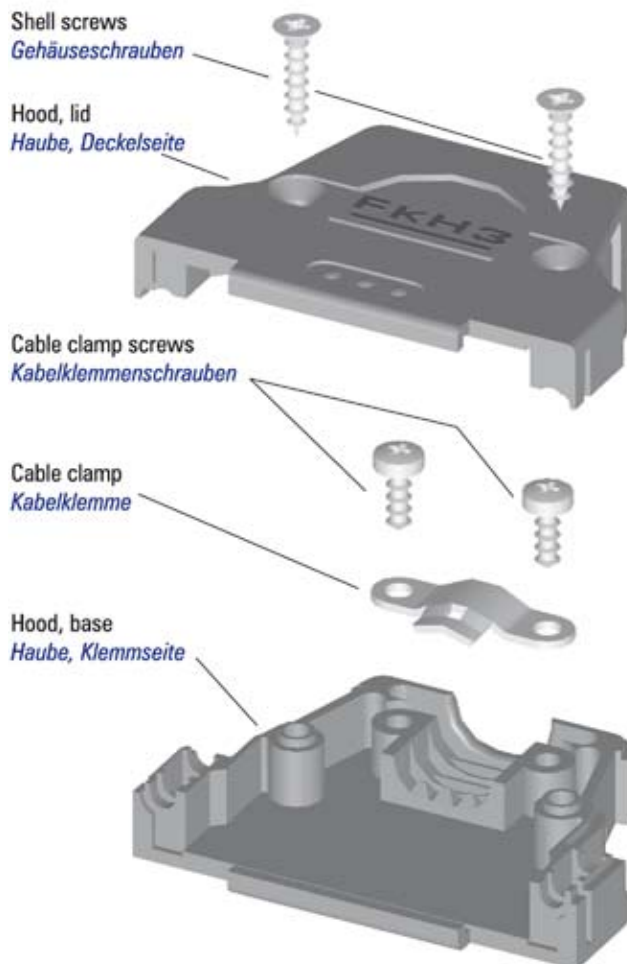



Plastic Hoods FKH, Straight Cable Outlet

Kunststoffhauben FKH, gerader Kabelausgang

Special Features of the Hood Series

Besondere Merkmale der Haubenserie

UL Recognized File No. E197631

- Easy assembly with snap-in system
- Straight cable outlet with strain relief
- Can be used in conjunction with locking, knurled thumb screws or locking hooks sizes 1 to 3
- Also available in shielded version (metallised)
- Modification (K189), to enable the use of slide locks, available
- Also available with rubber bushing FKT
- Hood shells in sizes 1 to 5 are supplied with indents for positioning when mounting hoods (Also available in other shell sizes on request)
- Montageerleichterung durch das Verrasten der beiden Haubenhälften
- gerader Kabelausgang mit Zugentlastung
- verwendbar mit Verriegelungsschrauben, Rändelschrauben oder Rasthaken Größe 1 bis 3
- auch in abgeschirmter Version verfügbar (metallisiert)
- Modifikation (K189) für den Einsatz von Gleitverriegelung verfügbar
- auch mit Knickschutztülle FKT erhältlich
- Haubengehäuse der Gehäusegrößen 1 bis 5 mit Tastnoppen zur Lageorientierung beim Stecken der Hauben (Andere Gehäusegrößen auf Anfrage)

Dimensions

Abmessungen

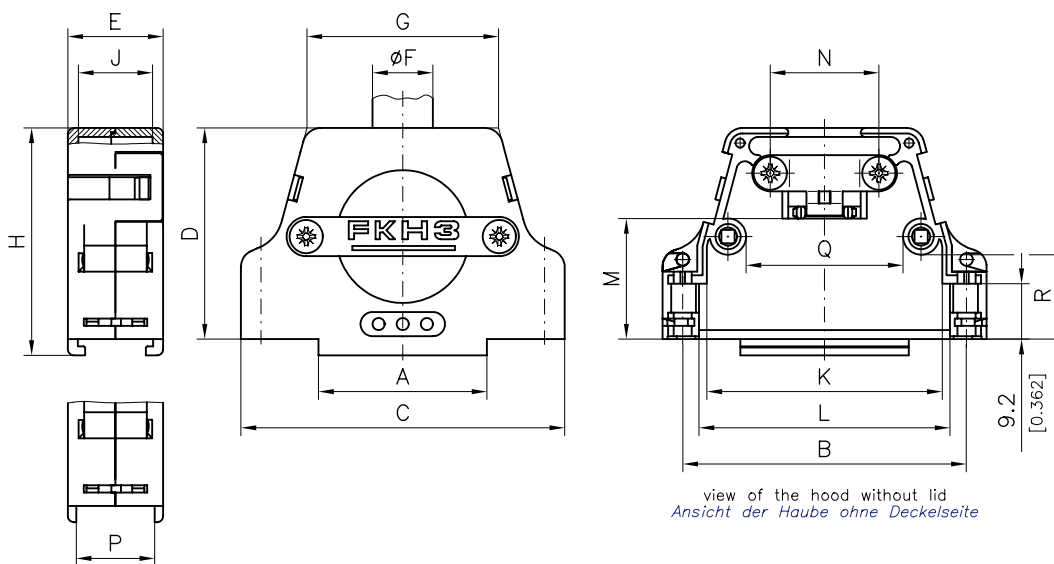

modification no. -K189 only (for slide lock system)
nur bei Modifikations-Nr. -K189 (für Gleitverriegelung)

Order No. Bestellnummer	Shell Size for No. of Contacts Gehäusegröße für Polzahl	A	B	C	D	E	Ø F		G	H	J	K	L	M	N	P	Q	R	
		±0,3 (±0.012)	±0,1 (±0.004)	±0,3 (±0.012)	±0,3 (±0.012)	±0,3 (±0.012)	Cable Diameter / Kabeldurchmesser without Rubber Bushing ohne Knickschutztülle min. - max.	with Rubber Bushing Order-Nr. mit Knickschutz- tülle Best.-Nr.	±0,3 (±0.012)	±0,3 (±0.012)	±0,3 (±0.012)	±0,3 (±0.012)	±0,3 (±0.012)	±0,5 (±0.020)	±0,3 (±0.012)	±0,3 (±0.012)	±0,3 (±0.012)	±0,3 (±0.012)	
FKH1*	1 / 9	10,0 (0.394)	25,0 (0.984)	31,2 (1.228)	31,8 (1.252)	16,0 (0.630)	4,5 - 7,0 (0.177) - (0.276)	FKT1-2	20,5 (0.807)	35,0 (1.378)	11,4 (0.449)	17,0 (0.669)	19,6 (0.772)	14,2 (0.559)	12,0 (0.472)	13,0 (0.512)	7,3 (0.287)	14,9 (0.587)	
FKH2*	2 / 15	16,1 (0.634)	33,3 (1.311)	40,0 (1.575)	32,0 (1.260)	16,0 (0.630)	4,5 - 7,0 (0.177) - (0.276)	FKT1-2	6,5 (0.256)	21,8 (0.858)	34,7 (1.366)	11,4 (0.449)	25,5 (1.004)	27,8 (1.094)	16,0 (0.630)	12,0 (0.472)	13,0 (0.512)	12,8 (0.504)	13,0 (0.512)
FKH3*	3 / 25	27,8 (1.094)	47,0 (1.852)	53,7 (2.114)	35,0 (1.378)	16,0 (0.630)	8,0 - 10,5 (0.315) - (0.413)	FKT3-4	9,0 (0.354)	32,0 (1.260)	37,7 (1.484)	11,4 (0.449)	39,0 (1.535)	41,6 (1.638)	20,0 (0.787)	18,0 (0.709)	13,0 (0.512)	25,6 (1.008)	14,0 (0.551)
FKH4**	4 / 37	44,4 (1.748)	63,5 (2.500)	70,2 (2.764)	41,0 (1.614)	16,0 (0.630)	8,0 - 10,5 (0.315) - (0.413)	FKT3-4	9,0 (0.354)	50,0 (1.969)	43,7 (1.720)	11,4 (0.449)	55,6 (2.189)	58,0 (2.283)	26,0 (1.024)	18,0 (0.709)	13,0 (0.512)	45,2 (1.780)	18,9 (0.744)
FKH5**	5 / 50	42,0 (1.654)	61,1 (2.406)	67,8 (2.669)	41,0 (1.614)	18,5 (0.728)	10,5 - 12,0 (0.413) - (0.472)	FKT5	11,5 (0.453)	48,0 (1.890)	43,7 (1.720)	14,0 (0.551)	53,4 (2.102)	55,7 (2.193)	26,0 (1.024)	18,0 (0.709)	15,8 (0.622)	42,4 (1.669)	19,1 (0.752)

* For individual packing, please add the suffix **E** to each order no. e.g. **FKH1E**. Standard 100 units per carton.

** For individual packing, please add the suffix **E** to each order no. e.g. **FKH4E**. Standard 50 units per carton.

* Für einzeln verpackt **E** anhängen z. B. **FKH1E**. Standard 100 Stück satzweise verpackt.

** Für einzeln verpackt **E** anhängen z. B. **FKH4E**. Standard 50 Stück satzweise verpackt.

Rubber bushings for cable listed in table are **not** delivered with hoods.
For the shielded version, please add the suffix **A** to each hood type.

Die Knickschutztüllen laut Tabelle sind **nicht** im Lieferumfang enthalten.
Für die abgeschirmte Version muss an den Haubentyp der Zusatz **A** angehängt werden.

Ordering example:

FKH hood, shell size 1 (hood type **FKH1**), shielded version (**A**), for slide lock system (modification **K189**)

Order number: **FKH1A-K189**

Bestellbeispiel:

FKH Haube, Gehäusegröße 1 (Haubentyp **FKH1**), abgeschirmte Version (**A**), für Gleitverriegelung (Modifikation **K189**)

Bestellnummer: **FKH1A-K189**



Plastic Hoods FKH, Straight Cable Outlet

Kunststoffhauben FKH, gerader Kabelausgang

Technical Data

Technische Daten

	FKH Standard Plastic Hood <i>FKH Kunststoffhaube, Standard</i>	FKH Shielded Plastic Hood <i>FKH Kunststoffhaube, abgeschirmt</i>
Material and platings <i>Material und Oberfläche</i>	PC+ABS, flame-retardant according UL94V-0 <i>PC+ABS, selbstverlöschend entsprechend UL94V-0</i>	ABS, flame-retardant according UL94V-0; plastic with nickel plating over Cu (Partly PC + ABS. More detailed information available on request.) <i>ABS, selbstverlöschend entsprechend UL94V-0; metallisiert Ni über Cu (zum Teil PC + ABS, genaue Informationen auf Anfrage)</i>
Temperature range <i>Temperaturbereich</i>	-35 °C bis 120 °C (-31° F to 248 ° F) <i>-35 °C bis 120 °C</i>	-35 °C bis 95 °C (-31° F to 203 ° F) <i>-35 °C bis 95 °C</i>
Max. torque * <i>max. Anzugsmoment *</i>	40 Ncm (0,295 fl.lb.) <i>40 Ncm</i>	40 Ncm (0,295 fl.lb.) <i>40 Ncm</i>
Colour / Plating <i>Farbe / Oberfläche</i>	Black <i>schwarz</i>	nickel <i>vernickelt</i>

* Not for locking screws

* Nicht für Verriegelungsschrauben

Delivery Quantity

Lieferumfang

			FKH1 - FKH5	FKH1A - FKH5A	
C O m p o n e n t S	Hood, lid <i>Haube, Deckelseite</i>		1	1	B a u t e i l e
	Hood, base <i>Haube, Klemmseite</i>		1	1	
	Shell screw <i>Gehäuseschraube</i>		2	2	
	Cable clamp <i>Kabelklemme</i>		1	1	
	Cable clamp screw <i>Kabelklemmschraube</i>		2	2	

Packing Units

Verpackungseinheiten

Please see page 108

siehe Seite 108



Plastic Hoods FKH, Straight Cable Outlet

Kunststoffhauben FKH, gerader Kabelausgang

Modifications

Modifikationen

Modifications <i>Modifikationen</i>	Modified Hoods <i>Modifizierbare Hauben</i>	Modification No's and Additions to Order No <i>Modifikationsnummern und Bestellnummernergänzung</i>	Ordering Example <i>Bestellbeispiel</i>
Modified hood to enable the use of slide locks <i>Modifizierte Haube zur Verwendung von Gleitverriegelung</i>	all <i>alle</i>	K189	FKH1-K189
Modified hood to enable the use of slide locks with 2 threaded block inserts FEK1/5 <i>Modifizierte Haube zur Verwendung von Gleitverriegelung mit 2 Einlegeklötzchen, komplett FEK1/5</i>	all <i>alle</i>	K205	FKH1-K205
Hood without connector retention lip with mounted threaded block insert 4-40 UNC <i>Haube ohne Steg, montiert mit Einlegeklötzchen, komplett 4-40 UNC</i>	all <i>alle</i>	K670	FKH1-K670
Hood without connector retention lip with mounted threaded block insert M3 <i>Haube ohne Steg, montiert mit Einlegeklötzchen, komplett M3</i>	all <i>alle</i>	K671	FKH1-K671
Hood with threaded block insert 4-40 UNC <i>Haube mit Einlegeklötzchen, komplett 4-40 UNC</i>	all <i>alle</i>	K774	FKH1-K774
Hood with threaded block insert M3 <i>Haube mit Einlegeklötzchen, komplett M3</i>	all <i>alle</i>	K775	FKH1-K775
Hood with 2 locking screws FVS1/5-K1163 <i>Haube mit 2 Verriegelungsschrauben FVS1/5-K1163</i>	all <i>alle</i>	K935	FKH1-K935
Hood with suitable rubber bushing <i>Haube mit passender Knickschutztülle</i>	all <i>alle</i>	K1119	FKH1-K1119
Hood with 2 locking screws FVS1/5-K1163M3 <i>Haube mit 2 Verriegelungsschrauben FVS1/5-K1163M3</i>	all <i>alle</i>	K1175	FKH1-K1175
Hood individually packed <i>Haube einzeln verpackt</i>	all <i>alle</i>	E	FKH1E
Hood with metal knurled thumb screws FRS1/5-... and with plastic head FRSK1/5-... <i>Haube mit Rändelschrauben Metall FRS1/5-... und mit Kunststoffkappe FRSK1/5-...</i>	all <i>alle</i>	Please see pages 112 to 114 <i>siehe Seite 112 bis 114</i>	

Further modifications on request.

Weitere Modifikationen auf Anfrage.









Plastic Hoods FKH, Straight Cable Outlet

Kunststoffhauben FKH, gerader Kabelausgang

Accessories

Zubehör

Order No. <i>Bestellnummer</i>	Description <i>Beschreibung</i>	Technical Data / Material <i>Technische Daten / Material</i>		
FVS1/5-K1163	Locking screw <i>Verriegelungs-schraube</i>		See page 111 <i>Siehe Seite 111</i>	
FVS1/5-K1163M3				Thread 4-40 UNC <i>Gewinde 4-40 UNC</i>
FVS1/5M2,5				Thread M3 <i>Gewinde M3</i>
FRS1/5...	Knurled thumb screw <i>Rändelschraube</i>		See page 112 <i>Siehe Seite 112</i>	
FRSK1/5...				Thread 4-40 UNC, M3, M2,5 <i>Gewinde 4-40 UNC, M3, M2,5</i>
FRSK1/5...	Knurled thumb screw with plastic cap <i>Rändelschraube mit Kunststoffkappe</i>		See page 114 <i>Siehe Seite 114</i>	
FKT1-2	Rubber bushing <i>Knickschutztülle</i>		See page 126 <i>Siehe Seite 126</i>	
FKT3-4				Hood size 1 + 2; Ø max. 6,5 (0.256) <i>Haubengröße 1 + 2; Ø max. 6,5</i>
FKT5				Hood size 3 + 4; Ø max. 9,0 (0.354) <i>Haubengröße 3 + 4; Ø max. 9,0</i>
FKT1-2A				Hood size 5; Ø max. 11,5 (0.453) <i>Haubengröße 5; Ø max. 11,5</i>
FKT3-4A				Hood size 1 + 2; Ø max. 8,0 (0.315) <i>Haubengröße 1 + 2; Ø max. 8,0</i>
FKT1-2K				Hood size 3 + 4; Ø max. 9,7 (0.382) <i>Haubengröße 3 + 4; Ø max. 9,7</i>
FKT3-4B				Hood size 1 + 2; Ø max. 7,0 (0.276) <i>Haubengröße 1 + 2; Ø max. 7,0</i>
FEK1/5	Threaded block insert <i>Einlegeklötzchen, komplett</i>		See page 118 <i>Siehe Seite 118</i>	
FEK1/5M3				Thread 4-40 UNC <i>Gewinde 4-40 UNC</i>
FEK1/5M2,5				Thread M3 <i>Gewinde M3</i>
F52K013	Cable reduction plate <i>Kabeldurchgangs-reduzierung</i>		Glass-reinforced polyester, grey <i>Glasfaserverstärkter Polyester, grau</i>	
F52K014				Thread M2,5 <i>Gewinde M2,5</i>
F52K015				Hood size 2 Ø 5,3 (0.209) <i>Haubengröße 2, Ø 5,3</i>
F52A013	Metallised cable reduction plate <i>metallisierte Kabeldurchgangs-reduzierung</i>		ABS, nickel plating over Cu <i>ABS, Ni über Cu</i>	
F52A014				Hood size 3 + 4 Ø 8,3 (0.327) <i>Haubengröße 3 + 4; Ø 8,3</i>
F52A015				Hood size 3 + 4 Ø 5,3 (0.209) <i>Haubengröße 3 + 4; Ø 5,3</i>

Accessories

Zubehör

Discontinued 1 Qrt 2010
abgekündigt 1. Quartal 2010