

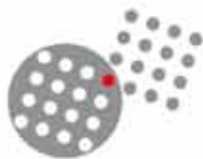

JBX Series

Sealed and Unsealed Push-Pull Connectors



SOURIAU
Connection Technology

JBX Series Push-Pull Connectors



Introduction

This catalogue presents the push-pull connectors ranges for industrial applications. These products are particularly suitable for high reliability and high quality applications where a simple yet fast method to connect/disconnect is required. Also suitable for high endurance and ease of operation in very limited spaces. The aesthetics of the product allows for perfect integration on front panel equipments.

Contents

Where and why push-pull	4
Selection guide	5
Push Pull Connectors	
• Main features - Part number system.....	6
• Shell types and dimensions.....	7-9
• Keying.....	10
• Contact layouts.....	11-13
• Options.....	14
• Technical characteristics.....	15
• Wiring and assembly instructions.....	16-21
JBX Series	
• Plug Assembly Instructions.....	22-26
• Receptacle Assembly Instructions.....	27-30
Environmentally Sealed Push Pull Connectors	
• Main features - Part number system.....	31
• Shell types and dimensions.....	31
• Keying - contact layouts.....	32-33
• Technical characteristics/Options.....	34-35
• Wiring and assembly instructions.....	36-
Accessories - Piece parts	38-39
Toolings	40-41
Conversion table	42
Request form	43



Where and Why push-pull ?

Medical



- Extremely fast and easy to use

- A thousand matings / unmatings

Professional audio video



- Enhanced appearance to add value to equipment

- Space saving

GPS



Instrumentation





Telecommunications



JBX Series Push-Pull Connectors



Selection guide

Push-Pull		
<p style="text-align: center;">Unsealed Multipin</p> <p style="text-align: center;">Solder, Crimp or PCB Contacts</p> <p style="text-align: center;">↓</p> <p style="text-align: center;">Keyed 2 to 30 contacts</p> <p style="text-align: center;">↓</p> <div style="text-align: center;">  </div> <p style="text-align: center;">JBX Series UL recognized</p>	<p style="text-align: center;">Sealed Multipin</p> <p style="text-align: center;">Solder, Crimp or PCB Contact</p> <p style="text-align: center;">↓</p> <p style="text-align: center;">Keyed 2 to 19 contacts</p> <p style="text-align: center;">↓</p> <div style="text-align: center;">  </div> <p style="text-align: center;">Sealed JBX Size2 UL recognized</p>	
Shell material	Brass	Brass
Insulator material	PEEK	PEEK
Shielding	Shielded (55 dB up to 100 MHz)	Shielded (55 dB up to 100 MHz)
Endurance	> 1 000 cycles	> 1 000 cycles
Current rating	up to 30 A	up to 30 A
Temperature range	-40°C; +125°C (-58° F; + 257° F)	-40°C; +125°C (-58° F; + 257° F)
Protection index	IP40	IP67

Push-pull locking system

The locking of the plug into the receptacle is achieved by a simple axial push on the outer shell.

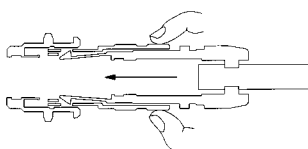

Connection cannot be broken by pulling the cable or any other parts of the plug than the outer shell.

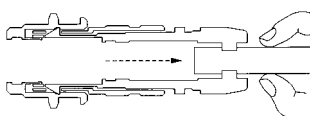

To unmate the plug from the receptacle, just pull axially the outer shell.

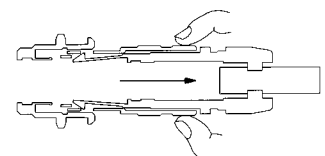

JBX Series Push-Pull Connectors



Major features & benefits

Key features

- Mechanically keyed : ensures correct polarisation and alignment.
- Contact layouts from 2 to 30 contacts.
- Wire gauges range from 30 AWG to 12 AWG.
- High contact density in a small space.
- Contact termination in either crimp, solder, PCB or right angle PCB contacts.



User advantages

Blister packaging



6-collet cluster

Allows a wide range of cable diameter applications for a single connector.



Removable contacts

Available crimp versions allow easier wiring and maintenance



Part number system

Basic series	JBX	FD	1	G	05	M	C	S	D	S	M	R
Shell type-Receptacle	ER-EA-SR-PC-ED-EP-EZ-SA											
Shell type - Plug	FD-FC-FF-FM-FN											
Shell size	00 - 0 - 1 - 2 - 3											
Keying	G - J - A - B											
Contact layout	02 ----- 30											
Contact type	M : pin F : socket											
Contact termination	C: crimp; S: solder; P*: straight PCB tails ; Q*: Right Angle PCB tails											
Surface plating	S: Outer shell brass alloy chrome over nickel plating N: Outer shell in brass alloy with black plating (consult SOURIAU USA)											
Obligatory Suffix	D: For all part numbers											
Contact Size	S: All contact diameters except .05 mm P: 0.5 mm contact dimensions only											
Cable Backnut Option	M: Connector with backnut for protective boot - Protective boot to order separately page 13											
Key Identifier	R: Red dot on shell for ED, ER, EZ, PC, SR, FC, FD, FF, FM & FN only											

* For receptacle with female contact only

JBX Series Push-Pull Connectors



Shell types

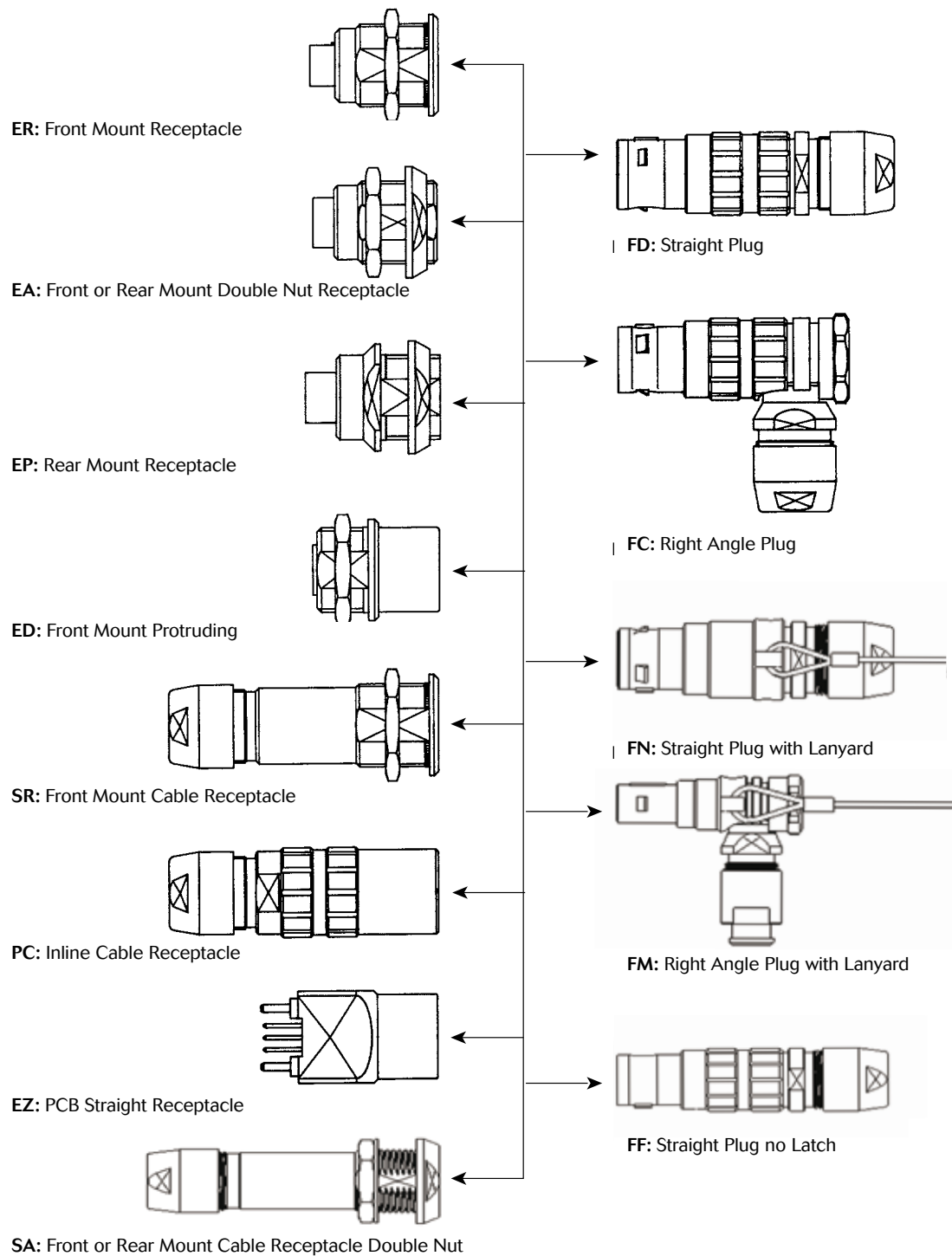

*Appropriate for right angle PCB contacts

JBX Series Push-Pull Connectors



Dimensions - receptacles

ER: Front Mount

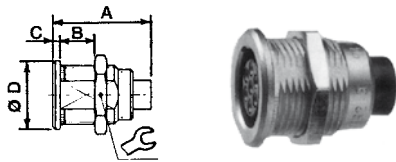

Size	00	0	1	2	3
A	14	19	21	24	28
B	6	8	10	10	12
C	0.8	1.2	1.5	1.8	2.0
Ø D	8	10	14	18	22

EA: Double Nut

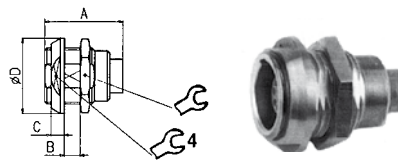

Size	0	1	2	3
A	19	21	24	28
B	6.7	8.3	8	9.5
C	2.5	3.2	3.8	4.5
Ø D	12	16	20	24

EP: Rear Mount

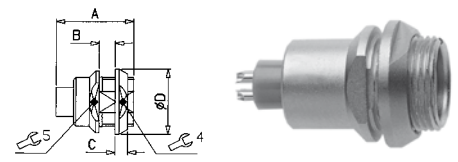

Size	0	1	2
A	19	21	24
B	4.5	6	6.5
C	2.5	3.2	3.8
Ø D	12	16	20

SA : Front or Rear Mount Double Nut

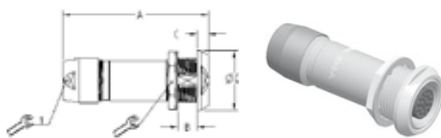

Size	0	1	2	3
A	38	43	50	59
B	-	-	6.5	-
C	2.5	3.2	3.8	-
Ø D	12	16	20	24

ED : Front Mount, Protruding

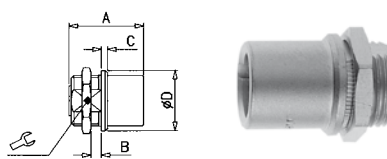

Size	0	1	2
A	19	21	24
B	3	4.5	6.3
C	1.2	1.5	1.8
Ø D	10	14	18

SR : Front Mount Cable Receptacle

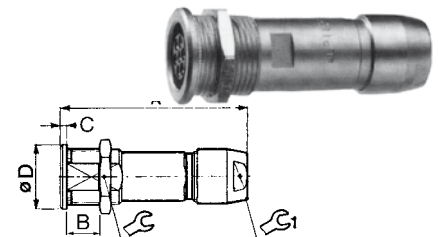

Size	0	1	2	3
A	38	43	50	59
B	8	10	10	12
C	1.2	1.5	1.8	2
Ø D	10	14	18	22

PC : In Line Receptacle

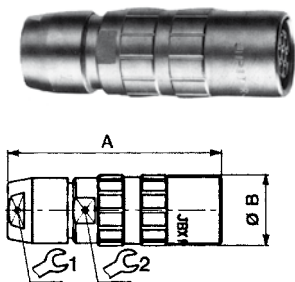

Size	0	1	2	3
A	38	43	50	59
Ø B	10	13	16	19.5

EZ : PCB

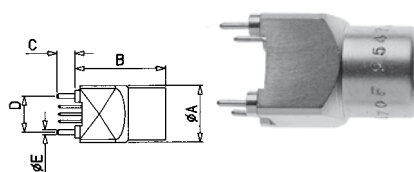

Size	0	1
A	10	12
Ø B	19	21
C	4	4
D	7.62	7.62
Ø E	1.1	1.1

JBX Series Push-Pull Connectors



Dimensions - plugs

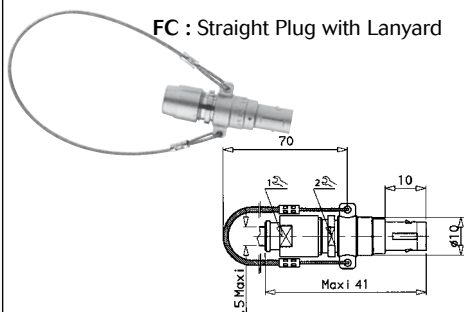

Size	0	1	2	3
A	30.5	36.5	42.5	50.5
B	20.5	25.5	30.5	35.5
C	29.5	33.5	36.5	45
Ø D	10	12	15	18

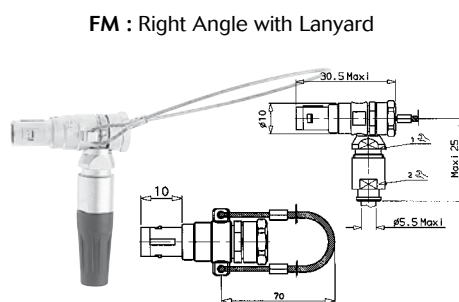

Size	0	1	2	3
A	30.5	36.5	42.5	50.5
B	20.5	25.5	30.5	35.5
C	29.5	33.5	36.5	45
Ø D	10	12	15	18

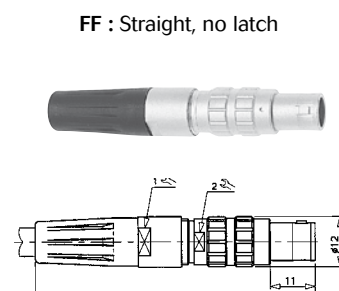

Size	0	1	2	3
A	30.5	36.5	42.5	50.5
B	20.5	25.5	30.5	35.5
C	29.5	33.5	36.5	45
Ø D	10	12	15	18

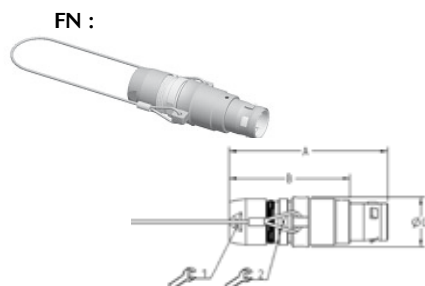

Size	00	0	1	2	3
A	31	39	45	52	62
B	23	29	34	40	47
Ø C	8	1	13	16	19

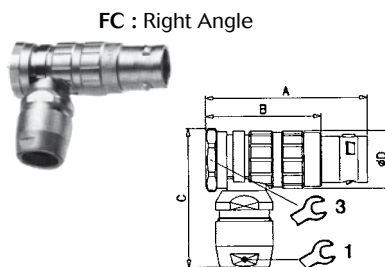

Size	0	1	2	3
A	30.5	36.5	42.5	50.5
B	20.5	25.5	30.5	35.5
C	29.5	33.5	36.5	45
Ø D	10	12	15	18

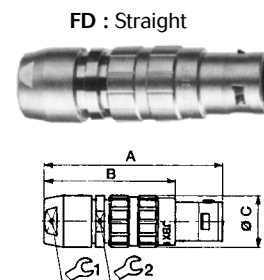

Size	00	0	1	2	3
A	31	39	45	52	62
B	23	29	34	40	47
Ø C	7	10	12	15	18

Range of cable diameters

With the plastic collet set supplied with the standard product, a wide range of cable diameters is allowed. Find below the maximum and the minimum for each size of shell (for information only because it can change with the cable characteristics).

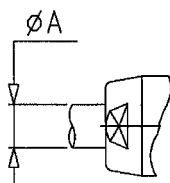

Size	00	0	1	2	3
Ø A min	1.1	1.5	2.0	3.5	4.9
Ø A max	3.5	5.5	7.5	9.7	12.0

JBX Series Push-Pull Connectors



Keying

Keying angles

JBX Series are mechanically keyed to ensure correct alignment of the inserts before the contacts mate.

«G» : normal inserts ; 0° keying angle, plugs with pin contacts, receptacles with socket contacts

Key	Single key way	Dual key way			
	G	J		A	B*
		Size 0-1	Size 2-3		
Keying angle	0°	45°	37.5°	30°	60°
Plug					
Receptacle					

Keying shells availability

Shell size	Key	ER	EA	ED	EP	EZ	SR	PC	FD	FC	SA	FN	FM	FF
00	G	●	●						●					
0	G	●	●	●	●	●	●	●	●	●	●	●	●	
	J	●	●	○	○	○	○	○	●	●	○	○	○	
	A	●	○	○	○	○	○	○	●	○	○	○	○	
	B	●	○	○	○	○	○	○	●	○	○	○	○	
1	G	●	●	●	●	●	●	●	●	●				●
	J	●	●	○	○	○	○	○	●	●				○
	A	●	○	○	○	○	○	○	●	○				○
	B	●	○	○	○	○	○	○	○	○				○
2	G	●	●	●	●		●	●	●	●	●			
	J	●	●	○	○		○	○	●	●	○			
	A	●	○	○	○		○	○	●	○	○			
	B		○	○	○		○	○	○	○	○			
3	G	●	●				●	●	●	●				

● Available for JBX Series

○ Contact Souriau for lead times

Contact SOURIAU for additional shell style configurations

JBX Series Push-Pull Connectors



Contact layouts

Shell size 00	
	04 
Male insulator wire side	
Solder	S
Crimp	
PCB straight tails	
PCB right angles	
Contact diameter mm	0.5
Solder Max. AWG	30
Crimp wire Max. AWG	
Max current rating	2
Test voltage (Vrms)	1000
Working Voltage (Vdc/Vrms)	500/350

Voltage Test Procedure







The **testing voltage** corresponds to the maximum voltage the connector is able to withstand in normal climatic conditions. The value is about 75% of the electrical breakdown voltage. The testing voltage level can be reached several times in connectors life, but never applied for a continuous duration.

The **working voltage** corresponds to the maximum voltage the connector is able to withstand continuously during its life time, in real environmental conditions, even with high temperature. The value is around 1/3 of the testing voltage.

Maximum current rating

This **indicated maximum current rating** corresponds to the maximum current that can be applied **simultaneously on each line of the connector mated pair**, continuously during its life time, in normal climatic conditions.

Remark : If the current is applied on only one contact of the layout, then an increased current value can be achieved over a long duration.

Shell size 0							
	02	03	04	05	06	07	08
Male insulator wire side							
Solder	S	S	S**	S**	S**	S**	S**
Crimp	C	C	C	C			
PCB straight tails*	P	P	P	P	P	P	P
PCB right angles*	Q	Q	Q	Q			
Contact diameter mm	0.9	0.9	0.7	0.7	0.5	0.5	0.5
Solder Max. AWG	24	24	26	26	28	28	28
Crimp wire Max. AWG	20	20	22	22			
Max current rating	10	8	7	6.5	2.5	2.5	2
Test voltage (Vrms)	1400	1300	1350	800	680	680	680
Working Voltage (Vdc/Vrms)	600/460	600/420	600/4205	400/220	320/220	320/220	320/220

**Inserts with fixed non removable contacts-* For receptacles with female contacts. -

Note : Contact numbering mating faces receptacle view: counterclockwise from key at position 1 -

Contact numbering mating faces plug view: clockwise from key at position 1

JBX Series Push-Pull Connectors



Contact layouts

Shell size 1									
	02	03	04	05	06	07	08	10	12
Male insulator wire side									
Solder	S	S	S	S	S**	S**	S**	S**	S**
Crimp	C	C	C	C	C	C	C	C	C
PCB straight tails*	P	P	P	P	P	P	P	P	P
PCB right angles*		Q	Q	Q	Q	Q	Q		
Contact diameter mm	1.3	1.3	0.9	0.9	0.7	0.7	0.7	0.5	0.5
Solder Max. AWG	20	20	24	24	26	26	26	28	28
Crimp wire Max. AWG	18	18	20	20	22	22	22		
Max current rating	15	12	10	9	7	7	5	2.5	2.5
Test voltage (Vrms)	1600	1300	1900	1400	1400	1400	1200	600	500
Working Voltage (Vdc/Vrms)	760/530	600/420	900/630	660/460	600/460	600/460	600/420	300/200	275/175

Shell size 2							
	02	03	04	05	06	07	08
Male insulator wire side							
Solder	S	S	S	S	S	S	S
Crimp	C	C	C	C	C	C	C
PCB straight tails*	XX	XX	P	P	P	P	P
PCB right angles*			Q	Q	Q	Q	Q
Contact diameter mm	1.3	1.3	1.3	1.3	1.3	1.3	0.9
Solder Max. AWG	16	18	20	20	20	20	24
Crimp wire Max. AWG	12	14	18	18	18	18	20
Max current rating	30	17	15	14	12	11	10
Test voltage (Vrms)	2100	1700	2400	1900	1900	1500	1700
Working Voltage (Vdc/Vrms)	1000/700	830/560	1000/800	900/630	900/630	730/500	830/560

**Inserts with fixed non removable contacts

* For receptacles with female contacts. XX Contact SOURIAU

Note : Contact numbering mating faces receptacle view: counterclockwise from key at position 1

Contact numbering mating faces plug view: clockwise from key at position 1

JBX Series Push-Pull Connectors



Shell size 2					
	10	12	16	18	19
Male insulator wire side					
Solder	S	S**	S**	S**	S**
Crimp	C	C	C	C	C
PCB straight tails*	P	P	P	P	P
PCB right angles*	Q	Q	Q		
Contact diameter mm	0.9	0.7	0.7	0.7	0.7
Solder Max. AWG	24	26	26	26	26
Crimp wire Max. AWG	20	22	22	22	22
Max current rating	8	7	6	5.5	5
Test voltage (Vrms)	1700	1700	1500	1400	1400
Working Voltage (Vdc/Vrms)	830/560	830/560	730/500	660/460	660/460

Shell size 3									
	03	04	07	08	10	14	18	22	30
Male insulator wire side									
Solder	S**	S**	S	S	S	S	S	S**	S**
Crimp	C	C	C	C	C	C	C	C	C
PCB straight tails	XX	XX	XX	P	P	P	P	P	P
PCB right angles									
Contact diameter mm	2	2	1.6	1.3	1.3	0.9	0.9	0.7	0.7
Solder Max. AWG	16	16	16	20	20	24	24	26	26
Crimp wire Max. AWG	12	12	14	18	18	20	20	22	26
Max current rating	25	25	15	12	12	9	7	5.5	3.5
Test voltage (Vrms)	3600	2500	2200	2000	1400	1700	1400	1200	800
Working Voltage (Vdc/Vrms)	1600/1200	1100/830	1100/730	830/560	660/460	830/560	660/460	560/400	400/260

**Inserts with fixed non removable contacts * For receptacles with female contacts. XX Contact SOURIAU

Note : Contact numbering mating faces receptacle view: counterclockwise from key at position 1

Contact numbering mating faces plug view: clockwise from key at position 1

JBX Series Push-Pull Connectors



Options

Protective boot

With each JBX connector, one protective boot can accept diverse cable diameters thus the end-user can manage various cable diameters with one SOURIAU part number.

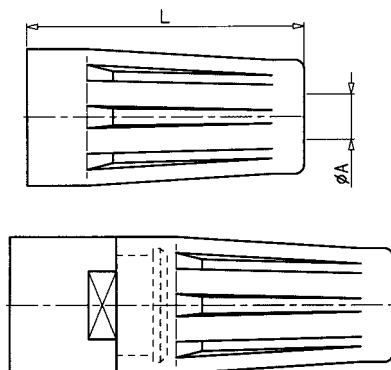

Part number	Shell size	Dimensions			
		Ø A	L	Ø Cable	
				Min	Max
JBX 00 MPN	00	1.5	15	1	3.5
JBX 0 MP*	0	2.2	20	1.5	5.5
JBX 1 MP *	1	2.6	25	2	7.5
JBX 2 MP *	2	4	30	3.5	9.7
JBX 3 MP*	3	5	35	4.9	12

*Color code - see chart below / in size 00 available only in black

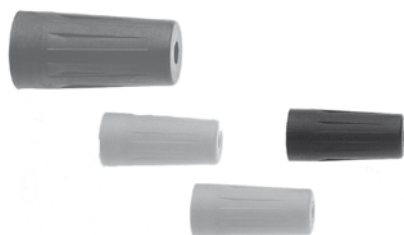

Color Code	Colors
A	blue
B	white
G	grey
J	yellow
M	brown
N	black
R	red
V	green
O	orange

Material :
ELASTOLLAN (PUR)

Working temperature :
- 40°C ; + 80°C
- 40°F ; + 176°F

Parts that require a protective boot need to be ordered with an M suffix. **Protective boots are ordered separately.**

Caps : an efficient protection against dust

Receptacle caps		Plug caps	
Part number	Shell size	Part number	Shell size
		JBX BF00	00
JBX BR0	0	JBX BF0	0
JBX BR1	1	JBX BF1	1
JBX BR2	2	JBX BF2	2
JBX BR3	3	JBXBF3	3



JBX Series Push-Pull Connectors



Technical characteristics

Material and treatment

UL recognized - homologation file E118235



Component	Material	Standard		Surface treatment (µm)		
		ISO	ASTM	Cr	Ni	Au
Outer shell and collet nut	Brass	CuZn40Pb3	C38500/C360	0.1 - 0.6	5 - 8	-
Latching sleeve	Brass	CuZn40Pb3	C38500/C360	-	5 - 8	-
Shielding ring	Brass	CuZn40Pb3	C38500/C360	-	3 - 7	-
Nut	Brass	CuZn40Pb3	C38500/C360	-	5 - 8	-
Half bushes	Brass	CuZn40Pb3	C38500/C360	-	5 - 8	-
Socket contact (1)	Cupro-nickel	CuNi1Pb1P	CDAC19150	-	3 - 5	0.5
Pin contact (1)	Brass	CuZn35Pb2	C35300/C360	-	3 - 5	0.5
Clip	Beryllium copper	CuBe1,9	C17200/C360	-	-	-

(1) Gold thickness as per MIL-G-45204C type 1, class 00

Component	Material	Color	Working temperature	
Insert	PEEK + 15% GF	brown	- 50°C + 250°C	- 58°F + 482°F
Collet	PA 6/6 + MoS2	black	- 55°C + 125°C	- 67°F + 257°F

Characteristics	Values	Mil Standard	Method	IEC Standard
Endurance	> 1000 cycles (except for 0.7 mm crimp contacts for which endurance is limited to 500 cycles)	MIL-STD 1344A	2016.1	IEC60512-5-9a
Shock	50g, duration 6 ms: contact Ø 0.7 mm and 0.9mm 100 g, duration 6 ms; contact Ø 1.3 mm - 1.6 mm and 2 mm	MIL-STD 1344A	2004.1	
Vibrations	>10 to 2000 Hz $\gamma = 15g$, contact Ø 0.7 mm and 0.9mm $\gamma = 20g$, contact Ø 1.3 mm - 1.6 mm and 2mm	MIL-STD 1344A	2005.1	
Protection Index	IP 40			IEC60529
Operating Temperature	with plastic collets } - 55°C + 125°C - 67°F + 257°F with optional metal collets } - 55°C + 200°C - 67°F + 392°F Only on request, consult SOURIAU			

JBX Series Push-Pull Connectors



Wiring & assembly instructions

Panel cutout

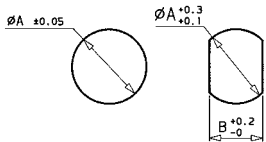

Size	00	0	1	2	3
$\varnothing A$	7.1	9.1	12.1	15.1	18.1
B	6.4	8.3	10.6	13.6	16.6

Removable contacts

Reliable design

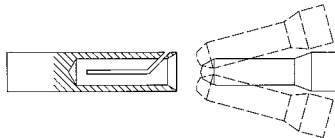

- Conical entry with chamfered edge on the socket contact and smooth slope on the pin contact ensure perfect concentric mating even when handled carelessly.
- The pressure spring of the socket contact maintains a constant force on the pin contact when mated.

Crimp contacts

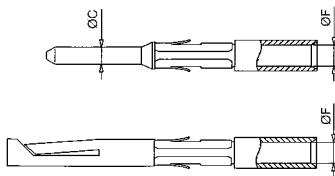

Contact		Usable cables			Max. current rating (A)	Contact resistance (m Ω)	Endurance (number of cycles)
$\varnothing C$	$\varnothing F$	Core section (mm 2)		AWG			
		Min	Max.				
0.7	0.85	0.129	0.326	22-24-26	7	5	500 Max.
0.9	1.1	0.205	0.518	20-22-24	10	3.5	> 1000
1.3	1.4	0.326	0.823	18-20-22	15	3	> 1000
1.6	1.9	0.823	2.081	14-16-18	17	2.5	> 1000
2.0	2.4	1.309	3.309	12-14-16	30	2.5	> 1000

Solder contacts

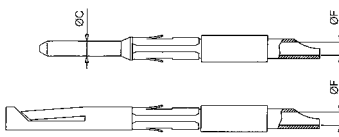

Contact		Usable cables			Max. current rating (A)	Contact resistance (m Ω)	Endurance (number of cycles)
$\varnothing C$	$\varnothing F$	Core section (mm 2)		AWG			
		Min	Max.				
0.7	0.7	-	0.30	26	7	5	500 Max.
0.9	0.8	-	0.21	24	10	3.5	> 1000
1.3	1.1	-	0.60	20	15	3	> 1000
1.6	1.5	-	0.93	18	17	2.5	> 1000
2	1.9	-	1.34	16	30	2.5	> 1000

The conductor bucket on the solder contacts is designed with an angle to form a cup into which the solder can flow easily.

Fixed contacts

Solder contacts

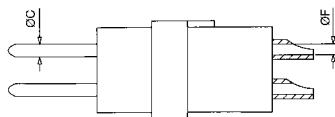

Contact		Shell size	Usable cables		Max. current rating (A)	Contact resistance (m Ω)	Endurance (number of cycles)
$\varnothing C$	$\varnothing F$		Core section (mm 2)	AWG			
0.5	0.4	00	0.06	30	5	10	> 1000
	0.5	0 - 1	0.096	28			
0.7	0.63	0-1-2-3	0.15	26	7	5	> 1000

Contacts for PCB

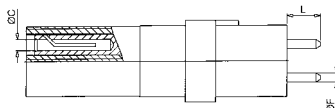

Contacts for PCB	Contact length dimensions "L"
PCB tail length size 0	dimension "L" 5.5 mm
0.7 mm female PCB tail length size 0	dimension "L" 3.5 mm
0.7 mm female PCB tail length size 1	dimension "L" 4.0 mm
0.7 mm female PCB tail length size 2	dimension "L" 6.0 mm
0.7 mm female PCB tail length size 3	dimension "L" 6.0 mm
0.9 mm female PCB tail length size 0	dimension "L" 3.5 mm
0.9 mm female PCB tail length size 1	dimension "L" 4.0 mm
0.9 mm female PCB tail length size 2	dimension "L" 6.0 mm
4.3 mm female PCB tail length size 1	dimension "L" 4.0 mm, dimension "F" 0.7 mm
4.3 mm female PCB tail length size 2	dimension "L" 6.0 mm, dimension "F" 0.7 mm
4.3 mm female PCB tail length size 3	dimension "L" 6.0 mm, dimension "F" 0.7 mm

JBX Series Push-Pull Connectors



Cable stripping for connectors with crimp contacts

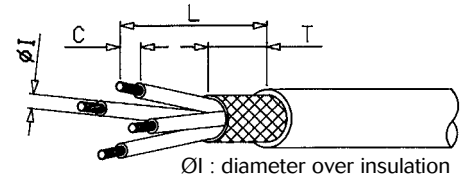

ØI : diameter over insulation

Shell Size	Ø Contacts	Ø I	Stripping for FD, SR, PC			Stripping for FC		
			L	C	T	L	C	T
0	0.7	≤ 1.35	15	4	7	19	4	7
		> 1.35		5.5			5.5	
	0.9	≤ 1.6	15	4	7	19	4	7
		> 1.6		5.5			5.5	
1	0.7	≤ 1.35	16	4	8	22	4	8
		> 1.35		5.5			5.5	
		≤ 1.6		4			8	
> 1.6	5.5	5.5						
	0.9	≤ 1.6	16	4	8	22	4	8
		> 1.6		5.5			5.5	
		≤ 2.1		4			8	
> 2.1	5.5	5.5						
	1.3	≤ 2.1	16	4	8	22	4	8
		> 2.1		5.5			5.5	
		≤ 2.6		4			9	
> 2.6	5.5	5.5						
	0.7	≤ 1.35	19	4	9	28	4	9
		> 1.35		5.5			5.5	
		≤ 1.6		4			9	
> 1.6	5.5	5.5						
	0.9	≤ 1.6	19	4	9	28	4	9
		> 1.6		5.5			5.5	
		≤ 2.1		4			9	
> 2.1	5.5	5.5						
	1.3	≤ 2.1	19	4	9	28	4	9
		> 2.1		5.5			5.5	
		≤ 2.6		4			9	
> 2.6	5.5	5.5						
	1.6	≤ 2.6	21	7	9	28	7	9
		> 2.6		5.5			5.5	
		≤ 3.2		4			9	
> 3.2	7	7						
	2.0	≤ 3.2	21	5.5	9	28	5.5	9
		> 3.2		7			7	
		≤ 1.35		4			10	
> 1.35	7	7						
	0.9	≤ 1.6	25	4	10	35	4	10
		> 1.6		7			7	
		≤ 2.1		4			10	
> 2.1	7	7						
	1.3	≤ 2.1	25	4	10	35	4	10
		> 2.1		7			7	
		≤ 2.6		5.5			10	
> 2.6	8.5	8.5						
	1.6	≤ 2.6	27	5.5	10	35	5.5	10
		> 2.6		8.5			8.5	
		≤ 3.2		5.5			10	
> 3.2	8.5	8.5						
	2.0	≤ 3.2	27	5.5	10	35	5.5	10
		> 3.2		8.5			8.5	

Cable stripping for connectors with crimp contacts

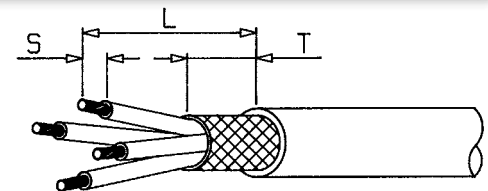

Shell Size	Ø Contacts	Stripping for FD, SR, PC			Stripping for FC		
		L	S	T	L	S	T
00	0.5	9	2	4	/	/	/
0	0.5	11	2	7	16	2	7
	0.7	12	3	7	16	3	7
	0.9	12	3	7	16	3	7
1	0.5	12	2	8	19	2	8
	0.7	13	3	8	19	3	8
	0.9	13	3	8	19	3	8
	1.3	13	3.5	8	19	3.5	8
2	0.7	16	3	9	25	3	9
	0.9	16	3	9	25	3	9
	1.3	16	3.5	9	25	3.5	9
	1.6	18	4	9	25	4	9
	2	18	4	9	25	4	9
3	0.7	20	3	10	30	3	10
	0.9	20	3	10	30	3	10
	1.3	20	3.5	10	30	3.5	10
	1.6	22	4	10	30	4	10
	2	22	4	10	30	4	10

JBX Series Push-Pull Connectors



Wiring & assembly instructions

Straight plug

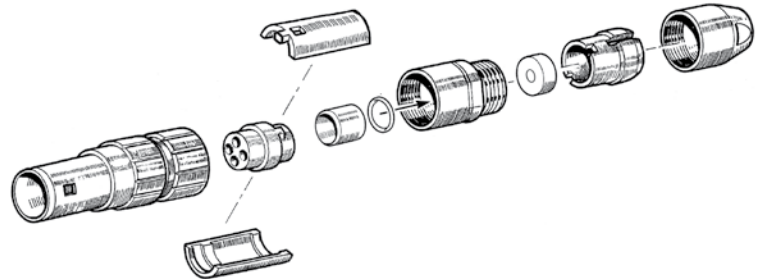

Cable stripping : see page 217

Connector preparation

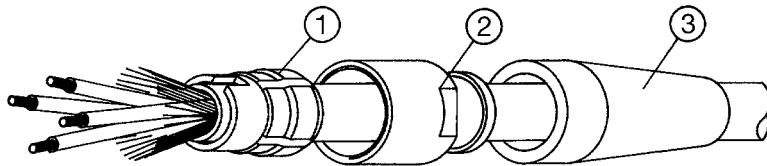

- 1 - Select the proper collet ①. (see page 217)
- 2 - Slide the protective boot ③ the backnut ② and the collet ① onto the cable.
- 3 - In case of a screened cable, combs out the screen and fold back over the collet ①.

Contact wiring : crimp contacts

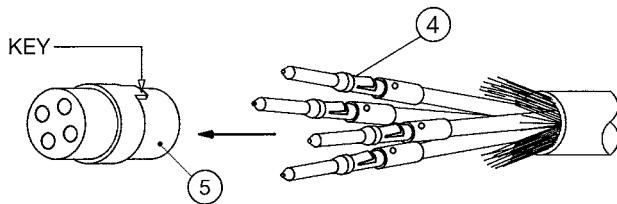

- 1 - Select the proper crimping tool (see page 48) and locator according to the connectors involved.
- 2 - Adjust the tool selector for the corresponding conductor AWG.
- 3 - Crimp the contacts ④ and then engage them into the insert cavities ⑤ till clip tightening.

Contact wiring : solder contacts

Fixed solder contacts 0.5 mm and 0.7 mm	Removable solder contacts from 0.9 mm to 2 mm
1 - Terminate the bucket contacts using solder method	1 - Solder the conductors to the contact buckets then engage them into the insert cavities ⑤ till clip holding

Connector assembly

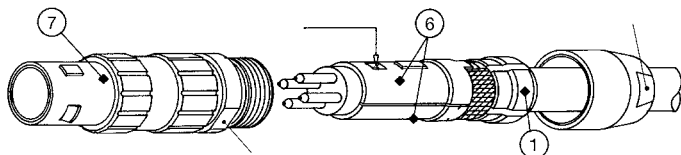

- 1 - Position 2 half bushes ⑦ on the insert ⑤ making sure that the insert key appears through window of one bush.
- 2 - Position the collet and the half bushes while maintaining the screen. Bush keys are seated in the collet keying slots.
- 3 - Position all the sub-assembly in the connector housing ⑦ making sure to keep sub-assembly aligned.
- 4 - Install the backnut ② and screw it. Use the two wrenches well positioned on the flats A and B. Place a wrench to grip flats B, use the other wrench to tighten the backnut at the flats A following the torque values on page 217.
- 5 - Install the protective boot ③ if exists.

JBX Series Push-Pull Connectors



90° Elbow plug

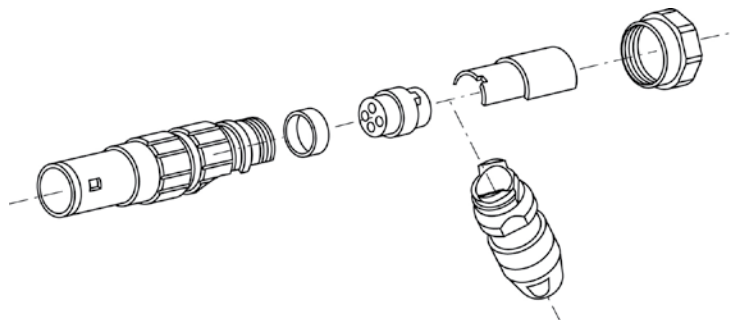

Cable stripping : see page 217

Connector preparation

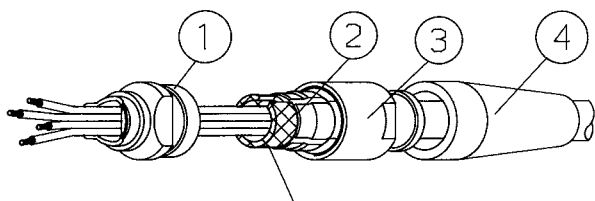

- 1 - Select the proper collet ② (see page 217).
- 2 - Slide the protective boot ⑦, the backnut ③, the collet ② and the elbow outlet ① onto the cable.
- 3 - In case of a screened cable, comb out the screen and fold back over the collet ②.
- 4 - Position in the elbow outlet making sure the anti-rotating keys are well aligned.
- 5 - Tighten the backnut ③ till bottomed.
- 6 - Install the protective boot ⑦ if exists.

Contact wiring : crimp contacts

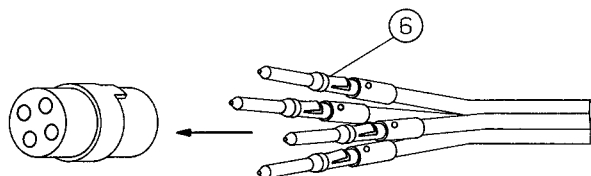

- 1 - Select the proper crimping tool (see page 49) and position according to connectors involved.
- 2 - Adjust the tool selector for the corresponding conductor AWG.
- 3 - Crimp the contacts ⑦ then engage them into the insert cavities ⑤ till clip tightening.

Contact wiring : solder contacts

Fixed solder contacts 0.5 mm and 0.7 mm	Removable solder contacts from 0.9 mm to 2 mm
1 - Terminate the bucket contacts using solder method	1 - Solder the conductors to the contact buckets then engage them into the insert cavities ⑤ till clip holding

Connector assembly

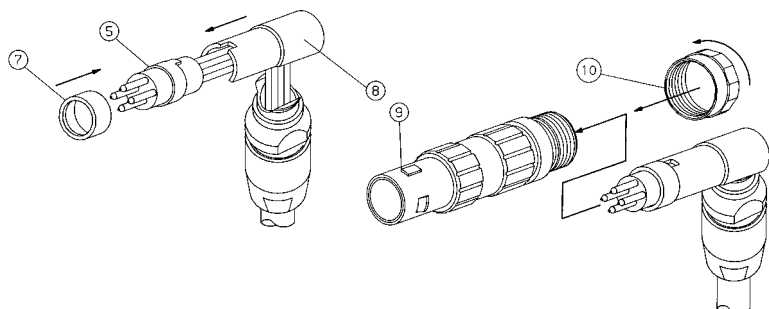

- 1 - Position the ring on the insert then engage all in the spacer
- 2 - Position all the sub-assembly in the connector housing with milled flats A of the elbow outlet facing to the rear of the plug housing.
- 3 - Tighten the screw at the torque values defined on page 217.

JBX Series Push-Pull Connectors



Wiring & assembly instructions

Collets selection according to cable diameters

4 or 6 collets per shell size allow a wide range of cable diameters for a single connector ; outer cable diameters are for reference only, since values will change with specific manufacturers cable properties.

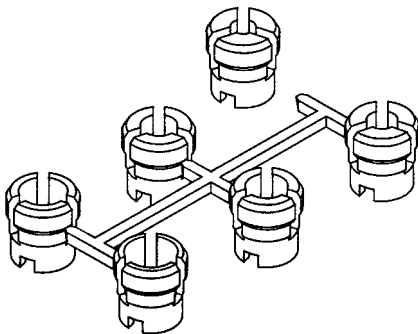

Collet number	Cable diameter				
	Shell size 00	Shell size 0	Shell size 1	Shell size 2	Shell size 3
1	1.1 - 1.9	1.5 - 2.5	2.0 - 2.5	3.5 - 4.7	4.9 - 6
2	2 - 28.8	2.6 - 3.5	2.6 - 3.5	4.8 - 5.7	6.1 - 7.2
3	2.9 - 3.5	3.6 - 4.5	3.6 - 4.5	5.8 - 6.7	7.3 - 8.4
4	-	4.6 - 5.5	4.6 - 5.5	6.8 - 7.7	8.5 - 9.6
5	-	-	5.6 - 6.6	7.8 - 7.7	9.7 - 10.8
6	-	-	6.7 - 7.5	8.8 - 9.7	10.9 - 12.0

*Metal collets: 4 to 6 elastic collets are included with each assembly, for alternative metal collets, please see chart below.

Metal collets

Optional discrete cable diameter metal collets are available. Part numbers can be configured by replacing the obligatory "D" character with maximum cable diameter from the chart below:

Shell size	Cable diameter
0	19, 25, 35, 45, 55, 57
1	25, 35, 45, 55, 66, 75, 77
2	47, 57, 67, 77, 87, 97
3	60, 72, 84, 96, 108, 120

Metal collet available for all sizes

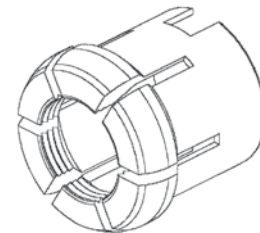







Discreet application based on cable diameter

JBX Series Push-Pull Connectors



Coupling torques

Tools (jaw dimensions)	7 x 0.5	9 x 0.6	12 x 1	15 x 1	18 x 1	Advised torques* in Nm				
						00	0	1	2	3
Size	00	0	1	2	3	00	0	1	2	3
	7	11	14	17	21	0.5	0.7	1.3	1.7	2
	6	8	10	13	15	0.7	0.8	1	1.5	2
	6	9	11	14	16	0.7	0.8	1	1.5	2
	-	10	12	15	17	-	0.4 to 0.5		0.5 to 0.7	
	-	10	13	17	20	0.5	0.7	1.3	1.7	2
	-	9	13	15	-	-	-	-	-	-

Torque values are the maximum allowable for each connector size.

Torque values will vary due to the type and size of the cable used.

*Apply thread lock to back nut prior to assembly.

Note : All the tooling numbers refer to the drawings page 205

Shielding

Tested according to MIL-STD 1344 A, method 3007

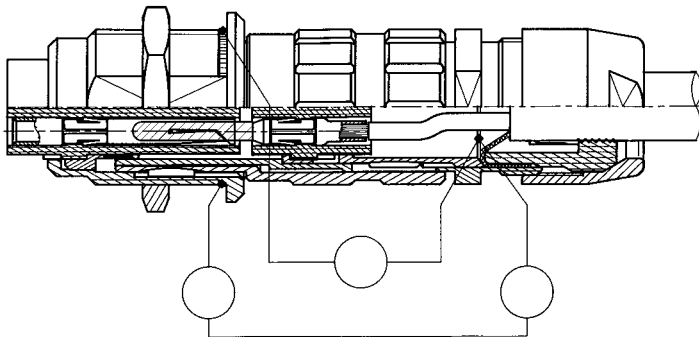

Shell size	Electrical continuity (mΩ)
00	4.5
0	4
1	3
2	2.5
3	2.5

JBX Series Push-Pull Connectors



Plug assembly instructions

1. Determine what size cable you will be using. Then select the proper collet number for that cable.

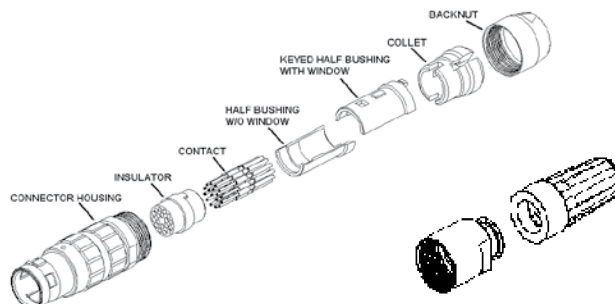

Collets selection according to cable diameters

3 or 5 collets per shell size allow a wide range of cable diameters for a single connector. Cable out diameters are for information only, since values will change with each cable construction.

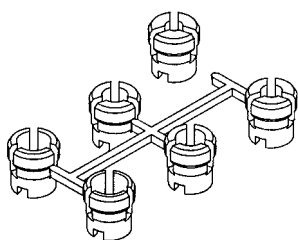

Collet Number	Cable diameter			
	Shell size 1	Size O option G	Shell size 1	Size option G
1	1.5 - 2.5	-	2 - 2.5	-
2	2.6 - 3.5	-	2.6 - 3.5	-
3	3.6 - 4.5	-	3.6 - 4.5	6.1 - 6.7
4	-	4.6 - 5.5	4.6 - 5.5	6.8 - 7.7
5	-	5.6 - 6	5.6 - 6	7.8 - 8

Collet number 4 in shell size 0 and collet number 6 in shell size 1 are not used

2. Strip the cable and each wire to the required strip length.

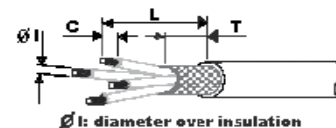

Cable stripping for connectors with crimp contacts

Shell Size	Ø Contacts	Ø I	Stripping for FD, SR, PC			Stripping for FC		
			L	C	T	L	C	T
0	0.7	≤ 1.35	15	4	7	19	4	7
		> 1.35		5.5			5.5	
	0.9	≤ 1.6	15	4	7	19	4	7
		> 1.6		5.5			5.5	
1	0.7	≤ 1.35	16	4	8	22	4	8
		> 1.35		5.5			5.5	
	0.9	≤ 1.6	16	4	8	22	4	8
> 1.6	5.5	5.5						
2	1.3	≤ 2.1	16	4	8	22	4	8
		> 2.1		5.5			5.5	
	0.7	≤ 1.35	19	4	9	28	4	9
> 1.35	5.5	5.5						
3	0.9	≤ 1.6	19	4	9	28	4	9
		> 1.6		5.5			5.5	
	1.3	≤ 2.1	19	4	9	28	4	9
> 2.1	5.5	5.5						
2	1.6	≤ 2.6	21	5.5	9	28	5.5	9
		> 2.6		7			7	
	2.0	≤ 3.2	21	5.5	9	28	5.5	9
> 3.2	7	7						
3	0.7	≤ 1.35	25	4	10	35	4	10
		> 1.35		7			7	
	0.9	≤ 1.6	25	4	10	35	4	10
		> 1.6		7			7	
	1.3	≤ 2.1	25	4	10	35	4	10
> 2.1	7	7						
1.6	≤ 2.6	27	5.5	10	35	5.5	10	
	> 2.6		8.5			8.5		
2.0	≤ 3.2	27	5.5	10	35	5.5	10	
> 3.2	8.5		8.5					

JBX Series Push-Pull Connectors



Cable stripping for connectors with solder contacts

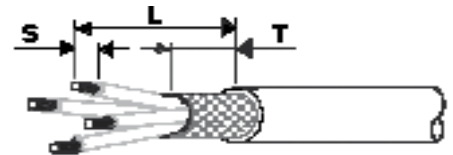

Shell size	Ø Contact	Stripping for FD, SR, PC			Stripping for FC		
		L	S	T	L	S	T
00	0.⑤	⑨	②	④	-	-	-
①	0.⑤	11	2	7	16	2	7
	0.⑦	12	3	7	16	3	7
	0.⑨	12	3	7	16	3	7
②	0.⑤	12	2	8	19	2	8
	0.⑦	13	3	8	19	3	8
	0.⑨	13	3	8	19	3	8
	1.③	13	3.5	8	19	3.5	8
③	0.⑦	16	3	9	25	3	9
	0.⑨	16	3	9	25	3	9
	1.③	16	3.5	9	25	3.5	9
	1.⑥	18	4	9	25	4	9
	2.⑩	18	4	9	25	4	9
④	0.⑦	20	3	10	30	3	10
	0.⑨	20	3	10	30	3	10
	1.③	20	3.5	10	30	3.5	10
	1.⑥	22	4	10	30	4	10
	2.⑩	22	4	10	30	4	10

- When assembling a plug with a protective boot (#3), prep the cable by taking the protective boot and sliding it with the small inside diameter first onto the cable. Then slide the end of the back nut (#2) that has the smaller diameter onto the cable. Next, take the collet (#1) and slide the end with the gripping teeth first onto the cable until the opposite end of the collet is flush with the cut end of the jacket. If the cable has shielding, fold back the braid so that it is covering the outside diameter of the collet. Do not place braid into any area of the alignment slots. Then insure that the braid does not interfere with the alignment slots of the collet.

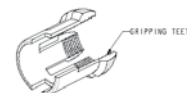
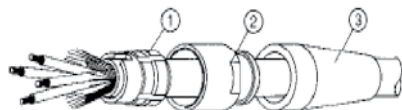

- Attach removable contacts to wires:

- If using crimped contacts, crimp the contacts onto the ends of the exposed wires using the proper crimping tool set on the correct AWG wire. (see FIGURE 4.A). After the contact has been crimped to the wire, check each contact to insure that the contact is securely crimped to the wire.

JBX Series Push-Pull Connectors



Plug assembly instructions

Figure 4.A

Locator for pin and socket 0.7 - 0.9 mm and 1.3 mm contacts



Shell size	Ø Contact	AWG	Male contact			Female contact		
			SOURIAU P/N	DANIELS P/N	ASTRO P/N	SOURIAU P/N	DANIELS P/N	ASTRO P/N
0	0.7	22 - 24 - 26	JBX 0 OUT LP07	86 - 223	/	JBX 0 OUT LP07	86 - 224	/
	0.9	20 - 22 - 24	JBX 0 OUT LP09	86 - 225	/	JBX 0 OUT LP09	86 - 226	/
1	0.7	22 - 24 - 26	JBX 1 OUT LP07	86 - 196	642 - 001	JBX 1 OUT LP07	86 - 197	642 - 004
	0.9	20 - 22 - 24	JBX 1 OUT LP09	86 - 198	642 - 002	JBX 1 OUT LP09	86 - 199	642 - 005
	1.3	18 - 20 - 22	JBX 1 OUT LP13	86 - 200	642 - 003	JBX 1 OUT LP13	86 - 201	642 - 006
2	0.7	22 - 24 - 26	JBX 2 OUT LP07	86 - 202	642 - 007	JBX 2 OUT LP07	86 - 203	642 - 010
	0.9	20 - 22 - 24	JBX 2 OUT LP09	86 - 204	642 - 008	JBX 2 OUT LP09	86 - 205	642 - 011
	1.3	18 - 20 - 22	JBX 2 OUT LP13	86 - 206	642 - 009	JBX 2 OUT LP13	86 - 207	642 - 012
3	0.7	22 - 24 - 26	JBX 3 OUT LP07	86 - 217	642 - 014	JBX 3 OUT LP07	86 - 214	642 - 017
	0.9	20 - 22 - 24	JBX 3 OUT LP09	86 - 218	642 - 015	JBX 3 OUT LP09	86 - 215	642 - 018
	1.3	18 - 20 - 22	JBX 3 OUT LP 13	86 - 219	642 - 016	JBX 3 OUT LP 13	86 - 216	642 - 019

Turret with locator for pin and socket 1.6 mm and 2 mm contacts



Shell size	Ø Contact	AWG	Male & female contacts		
			SOURIAU P/N	DANIELS P/N	ASTRO P/N
2	1.6	14 - 16 - 18	JBX 2 OUT LT16	TH 564	650 - 030
	2	12 - 14 - 16	JBX 2 OUT LT20	TH 565	650 - 031
3	1.6	14 - 16 - 18	JBX 3 OUT LT16	TH 566	650 - 038
	2	12 - 14 - 16	JBX 3 OUT LT20	TH 567	650 - 035

Crimping tool 1.6

Specifications MIL-C-22520 / 7.01			
	Contacts 0.7 mm - 0.9 mm and 1.3 mm	MIL P/N - SOURIAU P/N	Supplier P/N
		MIL-22520/7-01	DANIELS: MH860
Specifications MIL-C-22520 / 7.01			
	Contacts 1.6 mm and 2 mm	MIL P/N SOURIAU P/N	Supplier P/N
		MIL-22520/1-01	DANIELS: AF8 Buchanan: 615708

- b. If using soldered contacts, prep each wire with flux and then tin dip each exposed wire end. Next pre-load a piece of heat shrink 1.6 onto the wire (Individual heat shrink tubes are optional). Solder each wire to the solder cup end of the contact. To avoid shorts, make sure that no solder comes in contact with any other contact or wire on the connector.

JBX Series Push-Pull Connectors



After the contact has been soldered to the wire, check each contact to insure that the contact is securely soldered to the wire. Slide the pre-loaded heat shrink over the solder joint and shrink into place. Do not over-heat the solder joint area as it can cause the solder to re-flow or it could burn the wire insulation.

5. If inserting removable contacts:

a. Starting with the interface end of the contact, carefully insert each contact into the backside of the insulator that has the position loading path indicator (worm) on it. Start with the end of the position loading path indicator (worm) that has the half circle on it (Position #1). Then follow the position loading path indicator (worm) around the insulator. You will go counter clockwise if using a male contact and clockwise if using a female contact (see diagram below for the position loading path indicator (worm) layout). If the connector has center contacts, it is sometimes easier to start at the end of the position loading path indicator (worm) (last position) and work backwards. This is up to the assembler and the process they are using to insert the contacts. Make sure not to bend the contact when inserting it into the insulator. It is extremely important that the contact is completely seated in to the insulator. For the connector to function properly, the contact should click/snap into place when seated. To confirm the seating of the contact, check each contact for proper seating.

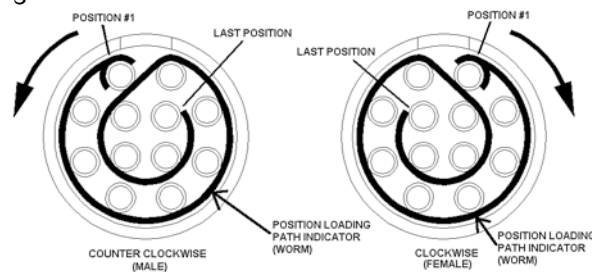

6. Removal of contacts:

a. Using the proper extraction tool insert the tool over the front of the contact and push contact out. Failure to use the proper extraction tool can result in damage to the contact.

TOOLINGS – JBX – JKX

Manual Extraction Tools

Contacts automatically extracted without pulling on the cable.

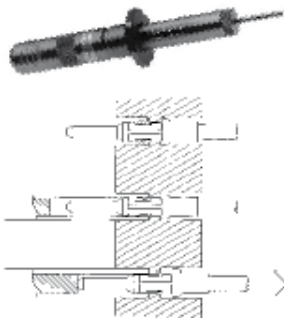

The extraction tool is the same for both male and female contacts.

Shell size	Ø Contacts	SOURIAU part number	ASTRO part number
0	0.7	JBX OUT DC07	ATJP 2045
	0.9	JBX OUT DC09	ATJP 2057
1	0.7	JBX OUT DC07	ATJP 2045
	0.9	JBX OUT DC09	ATJP 2057
	1.3	JBX OUT DC13	ATJP 2077
2	0.7	JBX OUT DC07	ATJP 2045
	0.9	JBX OUT DC09	ATJP 2057
	1.3	JBX OUT DC13	ATJP 2077
	1.6	JBX OUT DC16	ATJP 2095
	2.0	JBX OUT DC20	ATJP 2115
3	0.7	JBX OUT DC07	ATJP 2045
	0.9	JBX OUT DC09	ATJP 2057
	1.3	JBX OUT DC13	ATJP 2077
	1.6	JBX OUT DC16	ATJP 2095
	2.0	JBX OUT DC20	ATJP 2115

7. Take the keyed half bushing (#6) and place it over the insulator so that the window is lined up with the key on the insulator and the key on the half bushing is pointing to the back of the insulator (position loading path indicator (worm end)). Then take the half bushing without the window (#6) and place on the opposite side of the insulator so that both half bushings are aligned with each other.

JBX Series Push-Pull Connectors



Plug assembly instructions

8. Take the collet that is pre-loaded on the cable and align the slots in the collet with the keys on the end of the half bushings (you may need to move the braid away from the slots and spin the collet slightly). Once they are aligned, compress the assembly so that it is in line and there are no gaps between the collet & the half bushings. The braid should still be in place once the assembly is inserted.
9. Take a connector housing (#7) and slide it over the insulator so that the red dot on the connector housing lines up with the key on the half bushing with window. Push the whole assembly into the connector housing until it bottoms out. Insure that the keys are seated properly by turning the collet that is already aligned with the half bushings. If the collet does not turn, then the keys are correctly aligned. If the collet does turn, then you must withdraw the assembly & realign the keys.

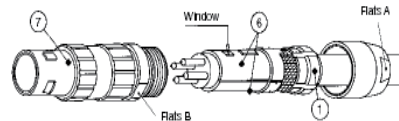

10. Once the assembly is installed into the connector housing and is aligned properly, apply thread lock to thread area. Then slide the back nut up until you can manually start the back nut threads onto the threaded end of the connector housing. Tighten the back nut up as far as you can by hand, then take the appropriate wrenches and place the wrenches onto the flats located on the connector housing. Do not over torque back nut as it can cause connector failure.
11. If the connector requires a protective boot, slide the boot over the lip on the back nut.
12. Potting of backend of plug with clipped contacts:

Clipped contacts are designed to float in the connector so that they self align when mated. It is sometimes necessary to pot the back end of the connector so that the contacts are sealed off from the environment. When this application is needed, it's recommended that the assembler engage a mating connector/alignment tool to the assembly being potted. Once the mating connector/alignment tool is engaged, it must be left engaged until the potting compound has hardened. This will insure that the true position requirements are met. If the application is for low volume, a mating connector can be used. If the application is for high volume, it is recommended that an alignment tool be purchased from the supplier..

Trouble shooting

Problem:	Cause:	Correction:
Contact will not seat in connector, contact backing out.	Wrong wire or insulation size, wrong strip length, poor crimping, broken clips, damaged insulator, removed contact without proper removal tool, bad crimp.	Use correct wire, adjust strip length, strip and recrimp with the new contact, replace insulator using wrong crimp tool, replace contact
Bent solder contact	Bent in handling, bent in soldering operation, connector assembled incorrectly.	Replace insert with contacts
	Pins and insulator were inserted into electrical test while unprotected by shell	
Connector will not release from mating part or operate correctly	Not using flats on latching sleeve and back nut to torque connector, improper assembly of the connector, over mold material inside connector	Release back-nut and re-torque, disassemble and reassemble, replace connector
Over tightened the back nut	Connector will not release from mating part or operate correctly, damage connector	Loosen back nut and retighten
Collet will not grip cable	Loose cable in connector	Check correct collet size is being used
Connector will not assemble	Incorrect alignment of key in connector, half bushings, connector housing, insulator, collet, braid in key slots in collet	Disassemble connector and reassemble connector-aligning keys, relocate braid in collet
Contact stubbing after mating	Bent contact and damaged contact, connector assembled incorrectly	Re-align contact, replace insert with contacts.
Electrical failure	Improper crimping, wrong wire strip length, wire loading incorrect location, poor solder joint	Remove contact with correct removal tool, reinstall new contact, and verify strip length



JBX Series Push-Pull Connectors

Receptacle assembly instructions

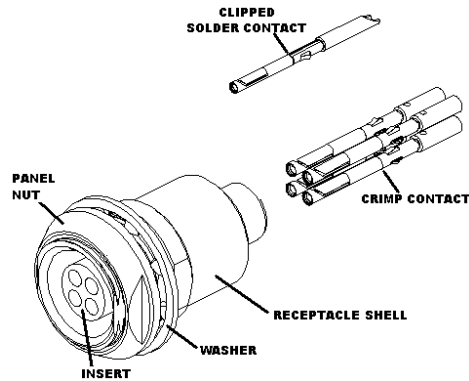

1. Select the proper JBX receptacle and contact size for the specific cable application by using the contact layout chart as depicted in the Push Pull catalog.
2. Strip the cable/wire to the required strip length.

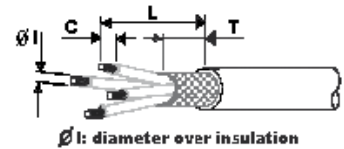

Wiring and assembly instructions

Cable stripping for connectors with crimp contacts

Shell Size	Ø Contacts	Ø I	Stripping for FD, SR, PC			Stripping for FC		
			L	C	T	L	C	T
0	0.7	≤ 1.35	15	4	7	19	4	7
		> 1.35		5.5			5.5	
	0.9	≤ 1.6	15	4	7	19	4	7
		> 1.6		5.5			5.5	
1	0.7	≤ 1.35	16	4	8	22	4	8
		> 1.35		5.5			5.5	
	0.9	≤ 1.6	16	4	8	22	4	8
		> 1.6		5.5			5.5	
1.3	≤ 2.1	16	4	8	22	4	8	
	> 2.1		5.5			5.5		
2	0.7	≤ 1.35	19	4	9	28	4	9
		> 1.35		5.5			5.5	
	0.9	≤ 1.6	19	4	9	28	4	9
		> 1.6		5.5			5.5	
	1.3	≤ 2.1	19	4	9	28	4	9
		> 2.1		5.5			5.5	
1.6	≤ 2.6	21	5.5	9	28	5.5	9	
	> 2.6		7			7		
2.0	≤ 3.2	21	5.5	9	28	5.5	9	
	> 3.2		7			7		
3	0.7	≤ 1.35	25	4	10	35	4	10
		> 1.35		7			7	
	0.9	≤ 1.6	25	4	10	35	4	10
		> 1.6		7			7	
	1.3	≤ 2.1	25	4	10	35	4	10
		> 2.1		7			7	
	1.6	≤ 2.6	27	5.5	10	35	5.5	10
		> 2.6		8.5			8.5	
2.0	≤ 3.2	27	5.5	10	35	5.5	10	
	> 3.2		8.5			8.5		

JBX Series Push-Pull Connectors



Receptacle assembly instructions

Cable stripping for connectors with solder contacts

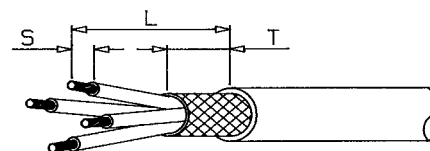

Shell size	Ø Contact	Stripping for FD, SR, PC			Stripping for FC		
		L	S	T	L	S	T
00	0.5	9	2	4	-	-	-
0	0.5	11	2	7	16	2	7
	0.7	12	3	7	16	3	7
	0.9	12	3	7	16	3	7
1	0.5	12	2	8	19	2	8
	0.7	13	3	8	19	3	8
	0.9	13	3	8	19	3	8
	1.3	13	3.5	8	19	3.5	8
2	0.7	16	3	9	25	3	9
	0.9	16	3	9	25	3	9
	1.3	16	3.5	9	25	3.5	9
	1.6	18	4	9	25	4	9
	2.0	18	4	9	25	4	9
3	0.7	20	3	10	30	3	10
	0.9	20	3	10	30	3	10
	1.3	20	3.5	10	30	3.5	10
	1.6	22	4	10	30	4	10
	2.0	22	4	10	30	4	10

3. Depending on application and shell type, the nut and washer may be removed before attaching the wires to the contacts.

4. Attach crimped contacts to wires:

- a. If using crimped contacts, crimp the contacts onto the ends of the exposed wires using the proper crimping tool and locator set on the correct AWG wire size (see FIGURE 4.A). After the contact has been crimped to the wire, check each contact to insure that the contact is securely crimped.



Locator for pin and socket 0.7 - 0.9 mm and 1.3 mm contacts

Shell size	Ø Contact	AWG	Male contact			Female contact		
			SOURIAU P/N	DANIELS P/N	ASTRO P/N	SOURIAU P/N	DANIELS P/N	ASTRO P/N
0	0.7	22 - 24 - 26	JBX 0 OUT LP07	86 - 223	/	JBX 0 OUT LP07	86 - 224	/
	0.9	20 - 22 - 24	JBX 0 OUT LP09	86 - 225	/	JBX 0 OUT LP09	86 - 226	/
1	0.7	22 - 24 - 26	JBX 1 OUT LP07	86 - 196	642 - 001	JBX 1 OUT LP07	86 - 197	642 - 004
	0.9	20 - 22 - 24	JBX 1 OUT LP09	86 - 198	642 - 002	JBX 1 OUT LP09	86 - 199	642 - 005
	1.3	18 - 20 - 22	JBX 1 OUT LP13	86 - 200	642 - 003	JBX 1 OUT LP13	86 - 201	642 - 006
2	0.7	22 - 24 - 26	JBX 2 OUT LP07	86 - 202	642 - 007	JBX 2 OUT LP07	86 - 203	642 - 010
	0.9	20 - 22 - 24	JBX 2 OUT LP09	86 - 204	642 - 008	JBX 2 OUT LP09	86 - 205	642 - 011
	1.3	18 - 20 - 22	JBX 2 OUT LP13	86 - 206	642 - 009	JBX 2 OUT LP13	86 - 207	642 - 012
3	0.7	22 - 24 - 26	JBX 3 OUT LP07	86 - 217	642 - 014	JBX 3 OUT LP07	86 - 214	642 - 017
	0.9	20 - 22 - 24	JBX 3 OUT LP09	86 - 218	642 - 015	JBX 3 OUT LP09	86 - 215	642 - 018
	1.3	18 - 20 - 22	JBX 3 OUT LP 13	86 - 219	642 - 016	JBX 3 OUT LP 13	86 - 216	642 - 019

JBX Series Push-Pull Connectors





Turret with locator for pin and socket 1.6 mm and 2 mm contacts

Figure 4.A

Shell size	Ø Contact	AWG	Male & female contacts		
			SOURIAU P/N	DANIELS P/N	ASTRO P/N
2	1.6	14 - 16 - 18	JBX 2 OUT LT16	TH 564	650 - 030
	2	12 - 14 - 16	JBX 2 OUT LT20	TH 565	650 - 031
3	1.6	14 - 16 - 18	JBX 3 OUT LT16	TH 566	650 - 038
	2	12 - 14 - 16	JBX 3 OUT LT20	TH 567	650 - 035

Crimping tool

Specifications MIL-C-22520 / 7.01			
	Contacts 0.7 mm - 0.9 mm and 1.3 mm	MIL P/N - SOURIAU P/N	Supplier P/N
		MIL-22520/7-01	DANIELS: MH860
Specifications MIL-C-22520 / 7.01			
	Contacts 1.6 mm and 2 mm	MIL P/N SOURIAU P/N	Supplier P/N
		MIL-22520/1-01	DANIELS: AF8 Buchanan: 615708

b. If using clipped solder contacts, prep each wire with flux and then tin dip each exposed wire end. Next pre-load a piece of heat shrink onto the wire (Individual heat shrink tubes are optional). Solder each wire to the solder cup end of the contact. To avoid shorts, make sure that no solder comes in contact with any other contact or wire on the connector. After the contact has been soldered to the wire, check each contact to insure that the contact is securely soldered to the wire. Slide the pre-loaded heat shrink over the solder joint and shrink into place. Do not over-heat the solder joint area as it can cause the solder to re-flow or it could burn the wire insulation.

5. If inserting terminated contacts:

a. Starting with the interface end of the contact, insert each contact into the backside of the insulator that has the position loading path indicator (worm) on it. Start with the end of the position loading path indicator (worm) that has the half circle on it (Position #1). Then follow the position loading path indicator (worm) around the insulator. You will go counter clockwise if using a male contact and clockwise if using a female contact (see diagram below for the position loading path indicator (worm) layout). If the connector has center contacts, it is some times easier to start at the end of the position loading path indicator (worm) (last position) and work backwards. This is up to the assembler and the process used to insert the contacts. Make sure not to bend the contact when inserting it into the insulator. It is extremely important that the contact is seated in the insulator for the connector to function properly. The contact should click/snapp into place when seated. Check each contact for proper seating.

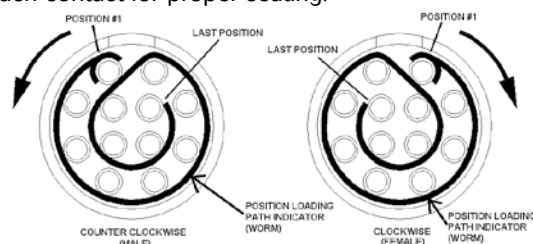

6. Removal of contacts:

Using the proper extraction tool (See FIGURE 6.A), insert the tool over the front of the contact and push contact out. Failure to use the proper extraction tool can result in damage to the contact.

JBX Series Push-Pull Connectors



Receptacle assembly instructions

Manual extraction tool

The extraction tool is the same for both male and female contacts.

Figure 6.A



Shell size	Ø contacts	SOURIAU part number	ASTRO part number
0	0.7	JBX OUT DC 07	ATJP 2045
	0.9	JBX OUT DC 09	ATJP 2057
1	0.7	JBX OUT DC 07	ATJP 2045
	0.9	JBX OUT DC 09	ATJP 2057
	1.3	JBX OUT DC 13	ATJP 2077
2	0.7	JBX OUT DC 07	ATJP 2045
	0.9	JBX OUT DC 09	ATJP 2057
	1.3	JBX OUT DC 13	ATJP 2077
	1.6	JBX OUT DC 16	ATJP 2095
	2.0	JBX OUT DC 20	ATJP 2115
3	0.7	JBX OUT DC 07	ATJP 2045
	0.9	JBX OUT DC 09	ATJP 2057
	1.3	JBX OUT DC 13	ATJP 2077
	1.6	JBX OUT DC 16	ATJP 2095
	2.0	JBX OUT DC 20	ATJP 2115

7. Potting of backend of receptacle with clipped contacts

Clipped contacts are designed to float in the connector so that they self align when mated. It is sometimes necessary to pot the backend of the connector so that the contacts are sealed off from the environment. When this application is needed, it is recommended that the assembler engage a mating connector/alignment tool to the assembly being potted. Once the mating connector/alignment tool is engaged, it must be left engaged until the potting compound has hardened. This will insure that the true position requirements are met. If the application is low volume, a mating connector can be used. If the application is for high volume, it is recommended that an alignment tool be purchased from the supplier.

Trouble shooting

Problem:	Cause:	Correction:
Contact will not seat in connector, contact backing out.	Wrong wire or insulation size, wrong strip length, poor crimping, broken clips, damaged insulator, removed contact without proper removal tool, bad crimp.	Use correct wire, adjust strip length, strip and recrimp with new contact, replace insulator, using correct crimp tool, replace contact.
Bent solder contact.	Bent in handling, bent in soldering operation, connector assembled incorrectly.	Re-align contact, replace insert with contacts.
Contact stubbing after mating.	Bent contact and damaged contact, connector assembled incorrectly.	Re-align contact, replace insert with contacts. If using clipped contacts and receptacle is potted, a mating connector must be applied to the connector that is being potted. This insures that contacts will be properly aligned.
Electrical failure	Improper crimping, wrong wire strip length, wire loading incorrect location, poor solder joint.	Remove contact with correct removal tool, reinstall new contact, and verify strength.

JBX Sealed Series Push-Pull Connectors



Major features & benefits

Key features

- Sealed IP 67 (mated connectors) (FE, EC, SE & PE)
- Watertight receptacles IP68 (HC, HG, HH & HM)
- Mechanically keyed : ensure correct polarisation and alignment.
- Contact arrangements : from 2 to 19 contacts.
- Wire gauge range from 26 AWG to 12 AWG.
- High contact density in a small space.
- Contact termination in either crimp, solder or PCB contacts.



User advantages

Wet environment
Splash proof IP 67



6-collet cluster
Allows a wide range of cable diameter applications for a single connector.



Removable contacts
Crimp versions allow easier wiring and maintenance.

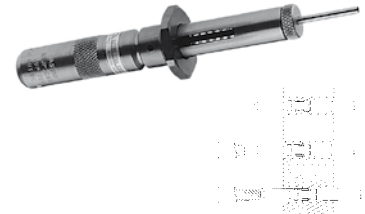

Part number system

Basic series	JBX	FD	2	G	05	M	C	S	D	S	M	R
Shell type-Receptacle	EC - HC - HG - HH - HM - PE - SE											
Shell type - Plug	FE											
Shell size	0 - 1 - 2											
Keying	G - J - A - B											
Contact layout	02 ----- 30											
Contact type	M : pin F : socket (in relation with keying)											
Contact termination	C: crimp; S: solder; P*: straight PCB tails ; Q*: Right Angle PCB tails											
Surface plating	S: Outer shell brass alloy chrome over nickel plating N: Outer shell in brass alloy with black plating (consult SOURIAU USA)											
Obligatory Suffix	D: For all part numbers											
Contact Size	S: All contact diameters except .05 mm P: 0.5 mm contact dimensions only											
Cable Backnut Option	M: Connector with backnut for protective boot - Protective boot to order separately page 13											
Key Identifier	R: Red dot on shell for HG, HH, PE, FF only											

* For receptacles with female contacts only.

JBX Sealed Series Push-Pull Connectors



Sealed Shell Types size 2

EC : Double Nut Panel Receptacle

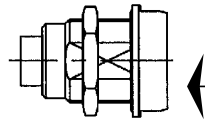

PE : In Line Receptacle

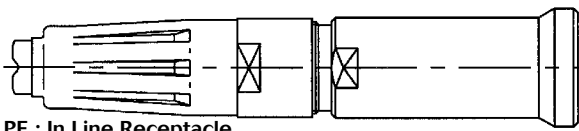

SE : Sealed Panel Mount Cable Receptacle

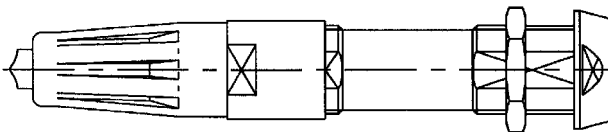

HC : Rear Mount Receptacle

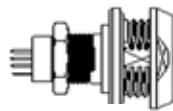

HG : Front Mount Receptacle

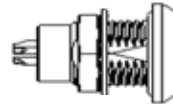

HH : Front Mount Receptacle

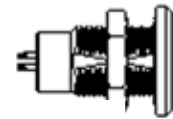

HM : Rear Mount Receptacle

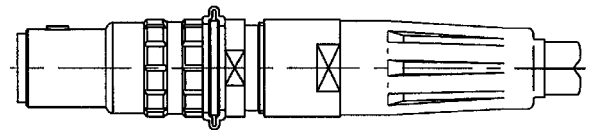
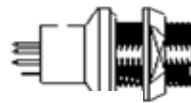

FE : Straight plug with cable clamping

JBX Sealed Series Push-Pull Connectors



Dimensions size 2

EC : Sealed Double Nut Panel Receptacle

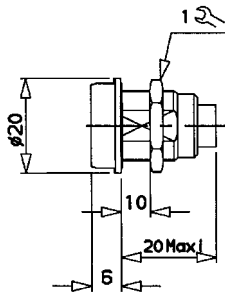

HC : Sealed Rear Mount Receptacle

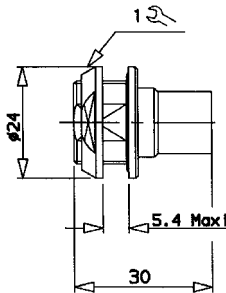

PE : Sealed In Line Receptacle

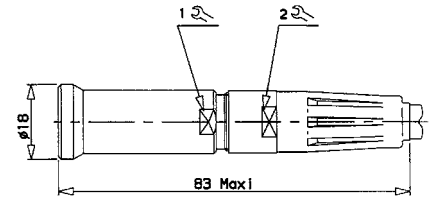

SE : Sealed Sealed Panel Mount
Cable Receptacle

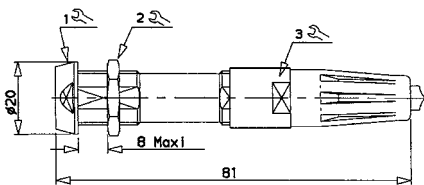

HG : Sealed Front Mount Receptacle

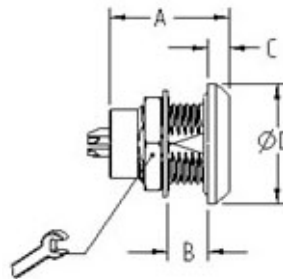

HH : Sealed Front Mount Receptacle

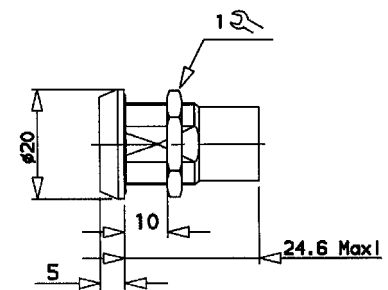

FE : Sealed Straight Plug with cable clamping

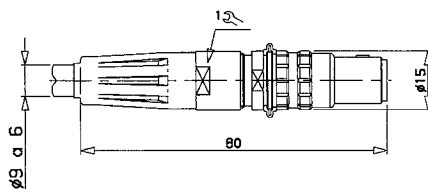

HM : Sealed Rear Mount Receptacle

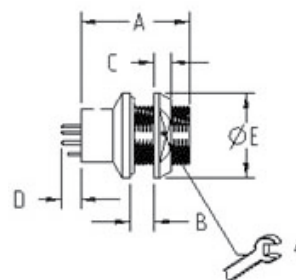

Shell size/styles:

Shell size	FE	EC	HC	HG	HH	HM	PE	SE
0	O	O	●	●	●	●	O	O
1	O	O	O	●	O	●	O	O
2	●	●	●		●	O	●	●

● Available for JBX Series - O Contact SOURIAU for additional shell styles and sizes -

Note 1 : For the plug, the in line receptacle and the panel mount cable receptacle, a black protective boot is included in the P/N.

JBX Sealed Series Push-Pull Connectors



Keying

Only G keying is available in standard version (0° keying angle, plugs with pin contacts, receptacles with female contacts) for the different types of shells.

Contact layouts Multi contact inserts

Shell size 0							
	02	03	04	05	06	07	08
Male insulator wire side							
Solder	S	S	S**	S**	S**	S**	S**
Crimp	C	C	C	C			
PCB straight tails*	P	P	P	P	P	P	P
PCB right angles*	Q	Q	Q	Q			
Contact diameter mm	0.9	0.9	0.7	0.7	0.5	0.5	0.5
Solder Max. AWG	24	24	26	26	28	28	28
Crimp wire Max. AWG	20	20	22	22			
Max current rating	10	8	7	6.5	2.5	2.5	2
Test voltage (Vrms)	1400	1300	1350	800	680	680	680
Working Voltage (Vdc/Vrms)	600/460	600/420	660/4205	400/220	320/220	320/220	320/220

**Inserts with fixed non removable contacts

* For receptacles with female contacts.

XX Contact SOURIAU

Note : Contact numbering mating faces receptacle view: counterclockwise from key at position 1

Contact numbering mating faces plug view: clockwise from key at position 1

Shell size 1									
	02	03	04	05	06	07	08	10	12
Male insulator wire side									
Solder	S	S	S	S	S**	S**	S**	S**	S**
Crimp	C	C	C	C	C	C	C		
PCB straight tails*	P	P	P	P	P	P	P	P	P
PCB right angles*		Q	Q	Q	Q	Q	Q		
Contact diameter mm	1.3	1.3	0.9	0.9	0.7	0.7	0.7	0.5	0.5
Solder Max. AWG	20	20	24	24	26	26	26	28	28
Crimp wire Max. AWG	18	18	20	20	22	22	22		
Max current rating	15	12	10	9	7	7	5	2.5	2.5
Test voltage (Vrms)	1600	1300	1900	1400	1400	1400	1200	600	500
Working Voltage (Vdc/Vrms)	760/530	600/420	900/630	660/460	600/460	600/460	600/420	300/200	275/175

JBX Sealed Series Push-Pull Connectors



Contact layouts

Shell size 2							
	02	03	04	05	06	07	08
Male insulator wire side							
Solder	S	S	S	S	S	S	S
Crimp	C	C	C	C	C	C	C
PCB straight tails*	XX	XX	P	P	P	P	P
PCB right angles*			Q	Q	Q	Q	Q
Contact diameter mm	1.3	1.3	1.3	1.3	1.3	1.3	0.9
Solder Max. AWG	16	18	20	20	20	20	24
Crimp wire Max. AWG	12	14	18	18	18	18	20
Max current rating	30	17	15	14	12	11	10
Test voltage (Vrms)	2100	1700	2400	1900	1900	1500	1700
Working Voltage (Vdc/Vrms)	1000/700	830/560	1000/800	900/630	900/630	730/500	830/560

Shell size 2					
	10	12	16	18	19
Male insulator wire side					
Solder	S	SXX	SXX	SXX	SXX
Crimp	C	C	C	C	C
PCB straight tails*	P	P	P	P	P
PCB right angles*	Q	Q	Q		
Contact diameter mm	0.9	0.7	0.7	0.7	0.7
Solder Max. AWG	24	26	26	26	26
Crimp wire Max. AWG	20	22	22	22	22
Max current rating	8	7	6	5.5	5
Test voltage (Vrms)	1700	1700	1500	1400	1400
Working Voltage (Vdc/Vrms)	830/560	830/560	730/500	660/460	660/460

**Inserts with fixed non removable contacts * For receptacles with female contacts. XX Contact SOURIAU

Note : Contact numbering mating faces receptacle view: counterclockwise from key at position 1
Contact numbering mating faces plug view: clockwise from key at position 1

JBX Sealed Series Push-Pull Connectors



Technical characteristics

The technical characteristics are the same as for the standard JBX series except the following ones:

Material - Specific additional elements

Component	Material	Color	Working temperatures	
Seals	Nitril & Silicon rubber	O'ring = black Plug seal = black	-40° C; +250° C	- 58° F; + 482 ° F
Protective boot	Elastolan (UPR)	Black	-40° C; +80° C	- 40° F; + 176 ° F

Mechanical and climatics - Specific additional elements

Characteristics	Values	
Protection Index	IP 67 (splashproof - 1/2 hour under 1 m of water)	
Operating temperatures	-40° C; +80° C	- 40° F; + 176 ° F

Options

Receptacle Cap: maintain IP67 rating

Size 1 Part-number = JBX BR2022

Size 2 Part-number = JBX BR1015

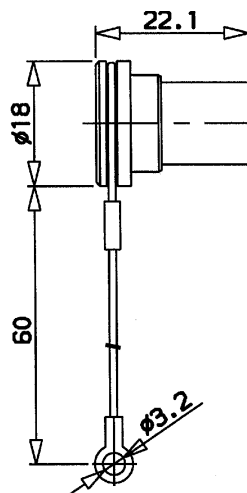

Wiring and assembly instructions

Panel cutout

The panel cutout is the same as for the JBX size 2 shells except for the HC (or HCE) type for which it corresponds to the JBX size 3 shells.

Range of cable diameter: from 6 to 9 mm

Operation to add during the plug assembly:

Deposit of watertight thread glue between the backnut ② on the drawing p215) and the connection shell ① on the drawing p215).

Advised glue = Loctite 542.

JBX Series Push-Pull Connectors



Accessories JBX

Insulating washer

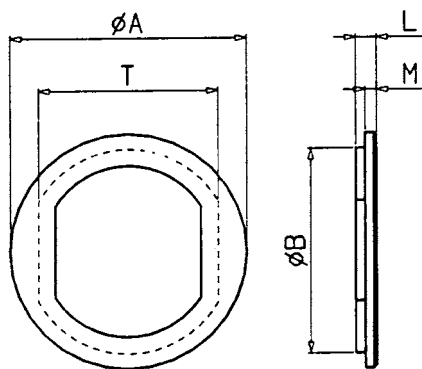

Part Number	Shell size	Ø A	B	L	M	N	T	E
JBX 00 RIN	00	10	8.8	1.8	1	0.8	8	4.4
JBX 0 RI*	0	12	10.8	1.8	1	0.8	9.9	6.4
JBX 1 RI*	1	16	13.8	1.8	1	0.8	12.2	8.4
JBX 2 RI*	2	21	17.8	2.2	1.2	0.8	16.2	8.2
JBX 3 RI*	3	25	21.8	2.2	1.2	0.8	20.2	10.1

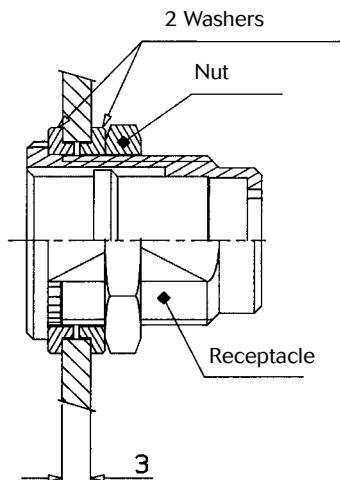

Material : PA 6/6

Working temperature : - 40°C ; + 125°C
- 40°F ; + 257°F

Color code	Colors
A	blue
B	white
G	grey
J	yellow
M	brown
N	black
R	red
V	green
O	orange

Using 2 washers for receptacle / panel insulating

For use with JBX only, not sealed JBX or JKX

Grounding washer

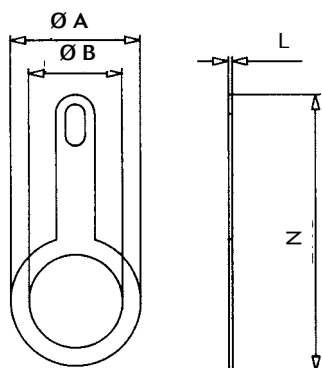

Part Number	Shell size	Dimensions			
		Ø A	Ø B	L	N
JAX RA 00 251	00	10	7.2	0.3	21.5
JAX RA 0 251	0	13	9.1	0.3	24
JAX RA 1 251	1	16	12.2	0.3	24
JAX RA 2 251	2	21	15.1	0.8	35
JAX RA 3 251	3	25	18.1	0.8	37

Material : - Brass
- Nickel plated (3 mm)

For use with JBX only, not sealed JBX or JKX

JBX Series Push-Pull Connectors



Accessories JBX

Locking washer

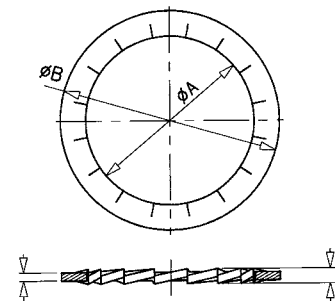

Part Number	Shell size	Dimensions			
		Ø A	Ø B	C	D
JAX RE 00	00	7.3	10	0.5	1
JAX RE 0	0	9.2	12.5	0.6	1
JAX RE 1	1	12.2	16	0.6	1

Piece part JBX

Crimp contacts (if ordered separately)

Shell size	Ø Contact	Part number	
		Crimp pin	Crimp socket
0	0.9	JBX 0 CT MC 09	JBX 0 CT FC 09
	0.7	JBX 0 CT MC 07	JBX 0 CT FC 07
1	1.3	JBX 1 CT MC 13	JBX 1 CT FC 13
	0.9	JBX CT 1 MC 09	JBX 1 CT FC 09
	0.7	JBX CT 1 MC 07	JBX 1 CT FC 07
	2	JBX 2 CT MC 20	JBX 2 CT FC 20
2	1.6	JBX 2 CT MC 16	JBX 2 CT FC 16
	1.3	JBX 2 CT MC 13	JBX 2 CT FC 13
	0.9	JBX 2 CT MC 09	JBX 2 CT FC 09
	0.7	JBX 2 CT MC 07	JBX 2 CT FC 07
	2	JBX 3 CT MC 20	JBX 3 CT FC 20
3	1.6	JBX 3 CT MC 16	JBX 3 CT FC 16
	1.3	JBX 3 CT MC 13	JBX 3 CT FC 13
	0.9	JBX 3 CT MC 09	JBX 3 CT FC 09
	0.7	JBX 3 CT MC 07	JBX 3 CT FC 07

Solder contacts (if ordered separately)

Shell size	Ø Contact	Part number	
		Solder pin	Solder socket
0	0.9	JBX 0 CT MS 09	JBX 0 CT FS 09
1	1.3	JBX 1 CT MS 13	JBX 1 CT FS 13
	0.9	JBX 1 CT MS 09	JBX 1 CT FS 09
2	2	JBX 2 CT MS 20	JBX 2 CT FS 20
	1.6	JBX 2 CT MS 16	JBX 2 CT FS 16
	1.3	JBX 2 CT MS 13	JBX 2 CT FS 13
	0.9	JBX 2 CT MS 09	JBX 2 CT FS 09
	2	JBX 3 CT MS 20	JBX 3 CT FS 20
3	1.6	JBX 3 CT MS 16	JBX 3 CT FS 16
	1.3	JBX 3 CT MS 13	JBX 3 CT FS 13
	0.9	JBX 3 CT MS 09	JBX 3 CT FS 09

Solder contacts of 0.5 mm and 0.7 mm of diameter not available separately (always fixed into the insulator)

JBX Series Push-Pull Connectors



Piece parts JBX

Inserts for removable solder and crimp contacts (if ordered separately)

Shell size	Insert	Insert part number	
		Pin contact	Socket contacts
0	02	JBX 0 BI 02 MS	JBX 0 BI 02 FS
	03	JBX 0 BI 03 MS	JBX 0 BI 03 FS
	04	JBX 0 BI 04 MS	JBX 0 BI 04 FS
	05	JBX 0 BI 05 MS	JBX 0 BI 05 FS
1	02	JBX 1 BI 02 MS	JBX 1 BI 02 FS
	03	JBX 1 BI 03 MS	JBX 1 BI 03 FS
	04	JBX 1 BI 04 MS	JBX 1 BI 04 FS
	05	JBX 1 BI 05 MS	JBX 1 BI 05 FS
	06	JBX 1 BI 06 MS	JBX 1 BI 06 FS
	07	JBX 1 BI 07 MS	JBX 1 BI 07 FS
	08	JBX 1 BI 08 MS	JBX 1 BI 08 FS
2	02	JBX 2 BI 02 MS	JBX 2 BI 02 FS
	03	JBX 2 BI 03 MS	JBX 2 BI 03 FS
	04	JBX 2 BI 04 MS	JBX 2 BI 04 FS
	05	JBX 2 BI 05 MS	JBX 2 BI 05 FS
	06	JBX 2 BI 06 MS	JBX 2 BI 06 FS
	07	JBX 2 BI 07 MS	JBX 2 BI 07 FS
	08	JBX 2 BI 08 MS	JBX 2 BI 08 FS
	10	JBX 2 BI 10 MS	JBX 2 BI 10 FS
	12	JBX 2 BI 12 MS	JBX 2 BI 12 FS
	16	JBX 2 BI 16 MS	JBX 2 BI 16 FS
	18	JBX 2 BI 18 MS	JBX 2 BI 18 FS
3	03	JBX 3 BI 03 MS	JBX 3 BI 03 FS
	04	JBX 3 BI 04 MS	JBX 3 BI 04 FS
	07	JBX 3 BI 07 MS	JBX 3 BI 07 FS
	10	JBX 3 BI 10 MS	JBX 3 BI 10 FS
	14	JBX 3 BI 14 MS	JBX 3 BI 14 FS
	18	JBX 3 BI 18 MS	JBX 3 BI 18 FS
	22	JBX 3 BI 22 MS	JBX 3 BI 22 FS
30	JBX 3 BI 30 MS	JBX 3 BI 30 FS	

Insert for pin contacts



Insert for socket contacts



Inserts with fixed solder contacts (if ordered separately)

Shell size	Insert	Insert part number	
		Pin contacts	Socket contacts
00	04	JBX 00 BI 04 MPS	JBX 00 BI 04 FPS
0	04	JBX 0 BI 04 MSS	JBX 0 BI 04 FSS
	05	JBX 0 BI 05 MSS	JBX 0 BI 05 FSS
	06	JBX 0 BI 06 MPS	JBX 0 BI 06 FPS
	07	JBX 0 BI 07 MPS	JBX 0 BI 07 FPS
1	07	JBX 1 BI 07 MSS	JBX 1 BI 07 FSS
	08	JBX 1 BI 08 MSS	JBX 1 BI 08 FSS
	10	JBX 1 BI 10 MPS	JBX 1 BI 10 FPS
2	12	JBX 2 BI 12 MSS	JBX 2 BI 12 FSS
	16	JBX 2 BI 16 MSS	JBX 2 BI 16 FSS
	18	JBX 2 BI 18 MSS	JBX 2 BI 18 FSS
	19	JBX 2 BI 19 MSS	JBX 2 BI 19 FSS
3	22	JBX 3 BI 22 MSS	JBX 3 BI 22 FSS
	30	JBX 3 BI 30 MSS	JBX 3 BI 30 FSS

Insert for pin contacts

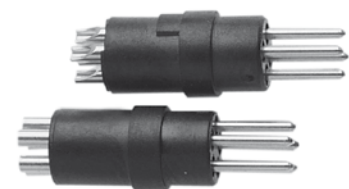

Insert for socket contacts





JBX Series Push-Pull Connectors

Toolings JBX

Manual extraction tool

Contacts automatically extracted

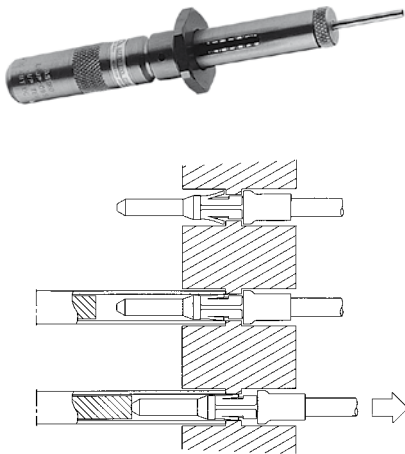

The extraction tool is similar for both male and female contacts.



Shell Size	Contacts	SOURIAU part number	ASTRO part number
0	0.7	JBX OUT DC 07	ATJP 2045
	0.9	JBX OUT DC 09	ATJP 2057
1	0.7	JBX OUT DC 07	ATJP 2045
	0.9	JBX OUT DC 09	ATJP 2057
	1.3	JBX OUT DC 13	ATJP 2077
2	0.7	JBX OUT DC 07	ATJP 2045
	0.9	JBX OUT DC 09	ATJP 2057
	1.3	JBX OUT DC 13	ATJP 2077
	1.6	JBX OUT DC 16	ATJP 2095
	2.0	JBX OUT DC 20	ATJP 2115
3	0.7	JBX OUT DC 07	ATJP 2045
	0.9	JBX OUT DC 09	ATJP 2057
	1.3	JBX OUT DC 13	ATJP 2077
	1.6	JBX OUT DC 16	ATJP 2095
	2.0	JBX OUT DC 20	ATJP 2115

The contact is automatically extracted without the need of pulling onto the cable.

Crimping tool

Specifications MIL-C-22520 / 7.01			
	Contacts 0.7 mm - 0.9 mm and 1.3 mm	MIL P/N - SOURIAU P/N	Supplier P/N
		MIL-22520/7-01	DANIELS: MH860 Buchanan: 616 336
Specifications MIL-C-22520 / 7.01			
	Contacts 1.6 mm and 2 mm	MIL P/N SOURIAU P/N	Supplier P/N
		MIL-22520/1-01	DANIELS: AF8 Buchanan: 615708

JBX Series Push-Pull Connectors



Locator for pin and socket 0.7 - 0.9 mm and 1.3 mm contacts



Shell size	Ø Contact	AWG	Male contact			Female contact		
			SOURIAU P/N	DANIELS P/N	ASTRO P/N	SOURIAU P/N	DANIELS P/N	ASTRO P/N
0	0.7	22 - 24 - 26	JBX 0 OUT LP 07	86 - 223	/	JBX 0 OUT LS 07	86 - 224	/
	0.9	20 - 22 - 24	JBX 0 OUT LP 09	86 - 225	/	JBX 0 OUT LS 09	86 - 226	/
1	0.7	22 - 24 - 26	JBX 1 OUT LP 07	86 - 196	642 - 001	JBX 1 OUT LS 07	86 - 197	642 - 004
	0.9	20 - 22 - 24	JBX 1 OUT LP 09	86 - 198	642 - 002	JBX 1 OUT LS 09	86 - 199	642 - 005
	1.3	18 - 20 - 22	JBX 1 OUT LP 13	86 - 200	642 - 003	JBX 1 OUT LS 13	86 - 201	642 - 006
2	0.7	22 - 24 - 26	JBX 2 OUT LP 07	86 - 202	642 - 007	JBX 2 OUT LS 07	86 - 203	642 - 010
	0.9	20 - 22 - 24	JBX 2 OUT LP 09	86 - 204	642 - 008	JBX 2 OUT LS 09	86 - 205	642 - 011
	1.3	18 - 20 - 22	JBX 2 OUT LP 13	86 - 206	642 - 009	JBX 2 OUT LS 13	86 - 207	642 - 012
3	0.7	22 - 24 - 26	JBX 3 OUT LP 07	86 - 217	642 - 014	JBX 3 OUT LS 07	86 - 214	642 - 017
	0.9	20 - 22 - 24	JBX 3 OUT LP 09	86 - 218	642 - 015	JBX 3 OUT LS 09	86 - 215	642 - 018
	1.3	18 - 20 - 22	JBX 3 OUT LP 13	86 - 219	642 - 016	JBX 3 OUT LS 13	86 - 216	642 - 019

Turret with locator for pin and socket 1.6 mm and 2 mm contacts



Shell size	Ø Contact	AWG	Male & female contacts		
			SOURIAU P/N	DANIELS P/N	ASTRO P/N
2	1.6	14 - 16 - 18	JBX 2 OUT LT16	TH 564	650 - 030
	2	12 - 14 - 16	JBX 2 OUT LT20	TH 565	650 - 031
3	1.6	14 - 16 - 18	JBX 3 OUT LT16	TH 566	650 - 038
	2	12 - 14 - 16	JBX 3 OUT LT20	TH 567	650 - 035

JBX Series Push-Pull Connectors



Conversion table

Millimeters / Inches

(mm)	(inches)	(mm)	(inches)	(mm)	(inches)
0.1	0.00394	8.2	0.32308	38.0	1.49720
0.2	0.00788	8.4	0.33096	38.5	1.51690
0.3	0.01182	8.6	0.33884	39.0	1.53660
0.4	0.01576	8.8	0.34672	39.5	1.55630
0.5	0.01970	9.0	0.35460	40.0	1.57600
0.6	0.02364	9.2	0.36248	40.5	1.59570
0.7	0.02758	9.4	0.37036	41.0	1.61540
0.8	0.03152	9.6	0.37824	41.5	1.63510
0.9	0.03546	9.8	0.38612	42.0	1.65480
1.0	0.03940	10.0	0.39400	42.5	1.67450
1.1	0.04334	10.5	0.41370	43.0	1.69420
1.2	0.04728	11.0	0.43340	43.5	1.71390
1.3	0.05122	11.5	0.45310	44.0	1.73360
1.4	0.05516	12.0	0.47280	44.5	1.75330
1.5	0.05910	12.5	0.49250	45.0	1.77300
1.6	0.06304	13.0	0.51220	45.5	1.79270
1.7	0.06698	13.5	0.53190	46.0	1.81240
1.8	0.07092	14.0	0.55160	46.5	1.83210
1.9	0.07486	14.5	0.57130	47.0	1.85180
2.0	0.07880	15.0	0.59100	47.5	1.87150
2.1	0.08274	15.5	0.61070	48.0	1.89120
2.2	0.08668	16.0	0.63040	48.5	1.91090
2.3	0.09062	16.5	0.65010	49.0	1.93060
2.4	0.09456	17.0	0.66980	49.5	1.95030
2.5	0.09850	17.5	0.68950	50.0	1.97000
2.6	0.10244	18.0	0.70920	51.0	2.00940
2.7	0.10638	18.5	0.72892	52.0	2.04880
2.8	0.11032	19.0	0.74860	53.0	2.08820
2.9	0.11426	19.5	0.76830	54.0	2.12760
3.0	0.11820	20.0	0.78800	55.0	2.16700
3.1	0.12214	20.5	0.80770	56.0	2.20640
3.2	0.12608	21.0	0.82740	57.0	2.24580
3.3	0.13002	21.5	0.84710	58.0	2.28520
3.4	0.13396	22.0	0.86680	59.0	2.32460
3.5	0.13790	22.5	0.88650	60.0	2.40340
3.6	0.14184	23.0	0.90620	61.0	2.44280
3.7	0.14578	23.5	0.92590	62.0	2.48220
3.8	0.14972	24.0	0.94560	63.0	2.52160
3.9	0.15366	24.5	0.96530	64.0	2.56100
4.0	0.15760	25.0	0.98500	65.0	2.60040
4.1	0.16154	25.5	1.00470	66.0	2.63980
4.2	0.16548	26.0	1.02440	67.0	2.67920
4.3	0.16942	26.5	1.04410	68.0	2.71860
4.4	0.17336	27.0	1.06380	69.0	2.75800
4.5	0.17730	27.5	1.08350	70.0	2.79740
4.6	0.18124	28.0	1.10320	71.0	2.83680
4.7	0.18518	28.5	1.12290	72.0	2.87620
4.8	0.18912	29.0	1.14260	73.0	2.91560
4.9	0.19306	29.5	1.16230	74.0	2.95500
5.0	0.19700	30.0	1.18200	75.0	3.15200
5.2	0.20488	30.5	1.20170	80.0	3.34900
5.4	0.21276	31.0	1.22140	85.0	3.54600
5.6	0.22064	31.5	1.24110	90.0	3.94000
5.8	0.22852	32.0	1.26080	100.0	7.88000
6.0	0.23640	32.5	1.28050	200.0	15.76000
6.2	0.24428	33.0	1.30020	400.0	23.64000
6.4	0.25216	33.5	1.31990	600.0	31.52000
6.6	0.26004	34.0	1.33960	800.0	39.40000
6.8	0.26792	34.5	1.35930	1000.0	47.28000
7.0	0.27580	35.0	1.37900	1200.0	63.04000
7.2	0.28368	35.5	1.39870	1600.0	78.80000
7.4	0.29156	36.0	1.41840	2000.0	126.08000
7.6	0.29944	36.5	1.43810		
7.8	0.30732	37.0	1.45780	3200.0	
8.0	0.31520	37.5	1.47750		

°C / °F

(°C)	(°F)
- 70	- 94
- 65	- 85
- 55	- 67
- 50	- 58
- 40	- 40
0	32
37	98.6
80	176
125	257
150	302
170	338
200	392
250	482

Pressure conversion

bar	psi	mmHg (torr)
10	145.0	7600
5	72.5	3800
2	29.0	1520
1	14.5	760
0.5	7.2	380
0.1	1.4	76

mbar	psi	mmHg (torr)
100	1.4	76
50	0.72	38
10	0.14	7.6
1.32	0.019	1

JBX Series Push-Pull Connectors



Request form please fill in and fax to SOURIAU - Customer service
(see the address page for your local contact)

Name : Tel number : Fax number :
Title : E-mail :
Company :
Address :

Applications :

- Medical Audio Video Instrumentation Nuclear physics
 GPS Transportation Metrology Other

Detailed description of end product, unit or application
.....

Connector description :

- Series : Shell configuration :
 Shell size : Protective boot : Color
 Number of contacts :
 Type of contacts : Solder Crimp Printed circuit 90° printed circuit
 Conductor AWG : Coax type : Other :

Electrical :

- Working voltage (AC/DC) : Current rating :
 Impedance (Ohms) : SWR : Frequency
 Contact resistance : Shielding :
 Fibre optics : Multimode Monomode.....

Environment :

- Temperature : Protection index (IP --) :
 Outside environment :
 Clear Splash proof Sterilization
 Dirt Fluids Radiation
 Chemicals Waterproof Gases
 Salt waterspray

Projections :

- Prototype quantity : Delivery date :
 Preseries quantity : Delivery date :
 Production quantity : Delivery date :
 Production per year : Number of years :
 Target pricing per connector :

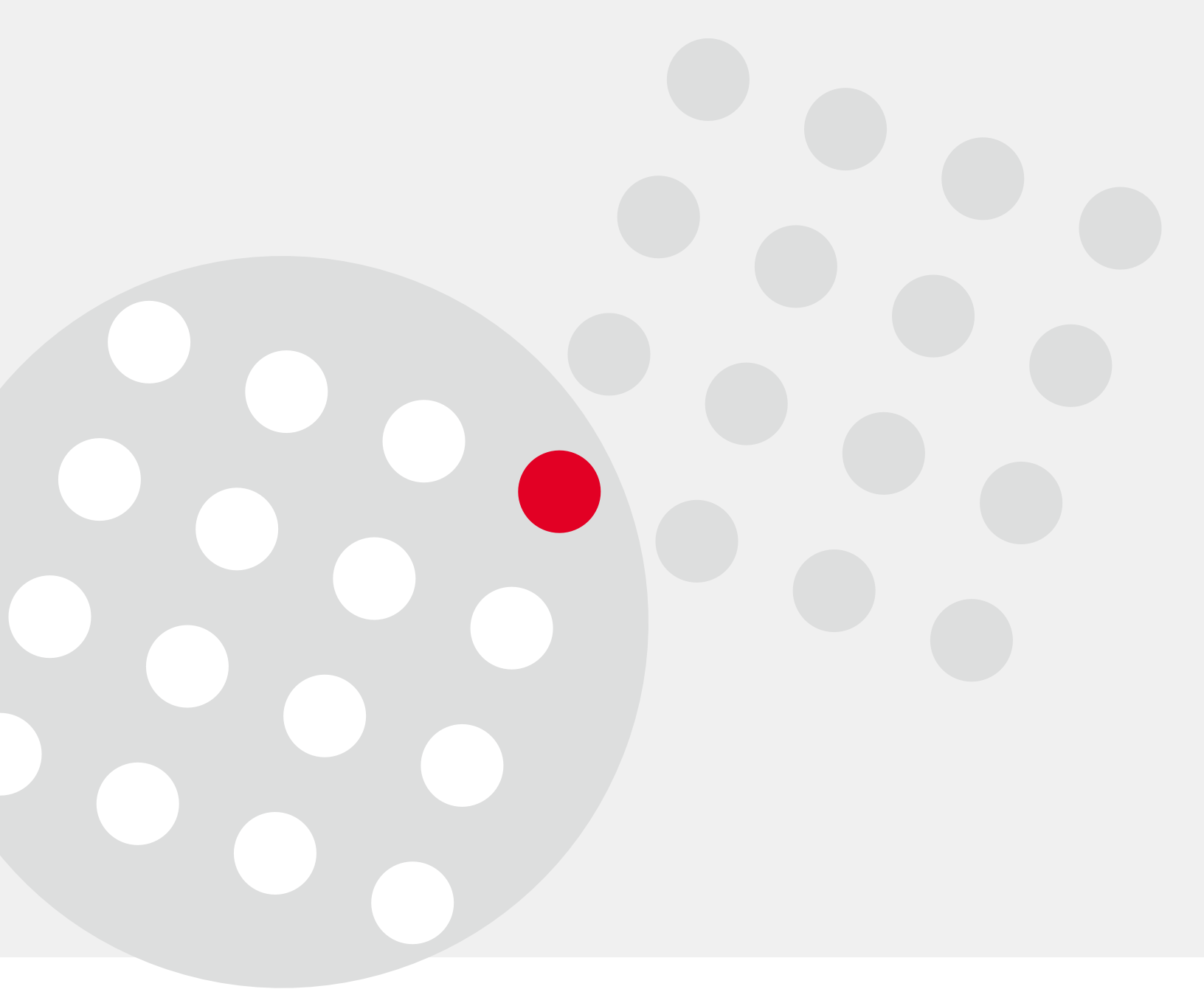

www.souriau.com

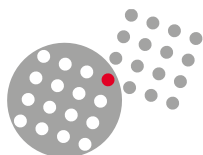

SOURIAU
Connection Technology