

MODEL BCN SERIES

BCN Series

- Thick Film
- Chip Resistor Arrays
- RoHS Compliant



MODEL STYLES

Model (Width)	# of Resistors	Circuit	Industry Size	Edge Finish / Termination		
				Scalloped Convex	Square Convex	Square Concave
Model BCN 2D (1.6mm)	2 Resistors	Isolated	0606	•		
Model BCN 10 (1.0mm)	4 Resistors	Isolated	0804		•	
Model BCN 16 4ABI (1.6mm)	4 Resistors	Isolated	1206			•
Model BCN 16 4A/AB (1.6mm)	4 Resistors	Isolated	1206	•	•	
Model BCN 16 8RB/8SB (1.6mm)	8 Resistors	Bussed	1206		•	
Model BCN 21 (2.1mm)	8 Resistors	Bussed	1608			•
Model BCN 4D (3.1mm)	4 Resistors	Isolated	2112	•		
Model BCN 4DBI (3.1mm)	4 Resistors	Isolated	2112			•
Model BCN 31 8RB/8SB (3.1mm)	8 Resistors	Bussed	2512		•	
Model BCN 31 8RBI/8SBI (3.1mm)	8 Resistors	Bussed	2512			•
Jumper Chip Array	4/8 Resistors	Isolated/Bussed	1206/2512	•	•	•

FEATURES

- Reliable monolithic construction
- Nickel barrier terminations
- Top side marking for easy identification
- Concave or convex termination styles
- Square or scalloped edges available

BENEFITS

- Saves board space over equivalent rated chip resistors
- Eliminates up to seven pick & place operations
- Single component reliability
- Leadless chip, reduced inductance
- Mounts close to active devices

APPLICATIONS

- Pull up / pull down resistors for digital IC's
- Series termination on high speed data busses
- Current limit for LED displays

General Note

BI Technologies reserves the right to make changes in product specification without notice or liability

© BI Technologies Limited • Glenrothes, Fife KY7 4NX, UK

Telephone: +44 (0) 1592 662200 • Facsimile: +44 (0) 1592 662299 • Website: www.bitechnologies.com • Email: sales@bitechnologies.co.uk

MODEL BCN SERIES

ELECTRICAL

Standard Resistance Range, Ohms	BCN 2D, BCN 4D, BCN 10, BCN 16 4:	10 to 1 Megohm
	BCN 16 8R / 8S:	100 to 1 Megohm
	BCN 31 8R / 8S:	22 to 1 Megohm
	BCN 21:	68 to 220K
Standard Resistance Tolerance		±5% (J Tol.)
		Optional: ±1% (F Tol.), BCN 4D, BCN 16 4, BCN31 8RB / 8SB Only ±2% (G Tol.), BCN 16 4, BCN31 8RB / 8SB Only
Operating Voltage, Maximum	BCN 2D, BCN 16 4, BCN 31 8R / 8S:	50Vdc or \sqrt{pr}
	BCN 10, BCN 16 8R / 8S, BCN 21:	25Vdc or \sqrt{pr}
	BCN 4D:	75Vdc or \sqrt{pr}
Power Rating, Watts at 70°C	BCN 2D:	63mW per Resistor / 125mW per Package
	BCN 4D:	125mW per Resistor / 500mW per Package
	BCN 10D:	31mW per Resistor / 125mW per Package
	BCN 16 4A:	63mW per Resistor / 250mW per Package
	BCN 16 8R / 8S:	32mW per Resistor / 250mW per Package
	BCN 21, BCN 31 8R / 8S:	63mW per Resistor / 500mW per Package

ENVIRONMENTAL

Operating Temperature Range		-55°C to +125°C
Temperature Coefficient of Resistance	BCN 2D:	±300ppm/°C
	BCN 4D, BCN 16 8R / 8S, BCN 21, BCN 31:	±200ppm/°C
	BCN 10, BCN 16 4:	±250ppm/°C
Moisture Resistance		1,000 hours @ +40°C, 95% R.H. (3.0% +0.1Ω ΔR)
High Temperature Operation		1,000 hours @ 70°C (3.0% +0.1Ω ΔR)
Short Time Overload		2.5 X rated voltage, 5 seconds (2.0% +0.1Ω ΔR)
Temperature Cycling		-55°C to +125°C, 5 cycles (1.0% +0.1Ω ΔR)
Resistance to Solder Heat		260°C for 10 seconds (1.0% +0.1Ω ΔR)
Load Life		1,000 hours @ 70°C (3.0% +0.1Ω ΔR)

CONSTRUCTION

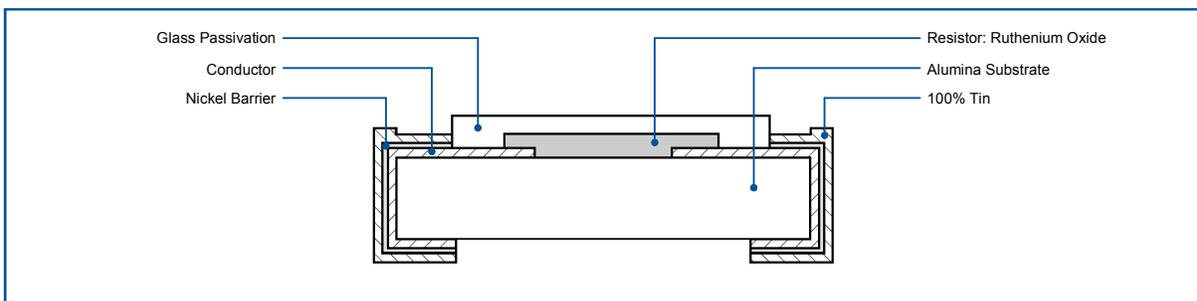

General Note

BI Technologies reserves the right to make changes in product specification without notice or liability

© BI Technologies Limited • Glenrothes, Fife KY7 4NX, UK

Telephone: +44 (0) 1592 662200 • Facsimile: +44 (0) 1592 662299 • Website: www.bitechnologies.com • Email: sales@bitechnologies.co.uk

MODEL BCN SERIES

ELECTRICAL

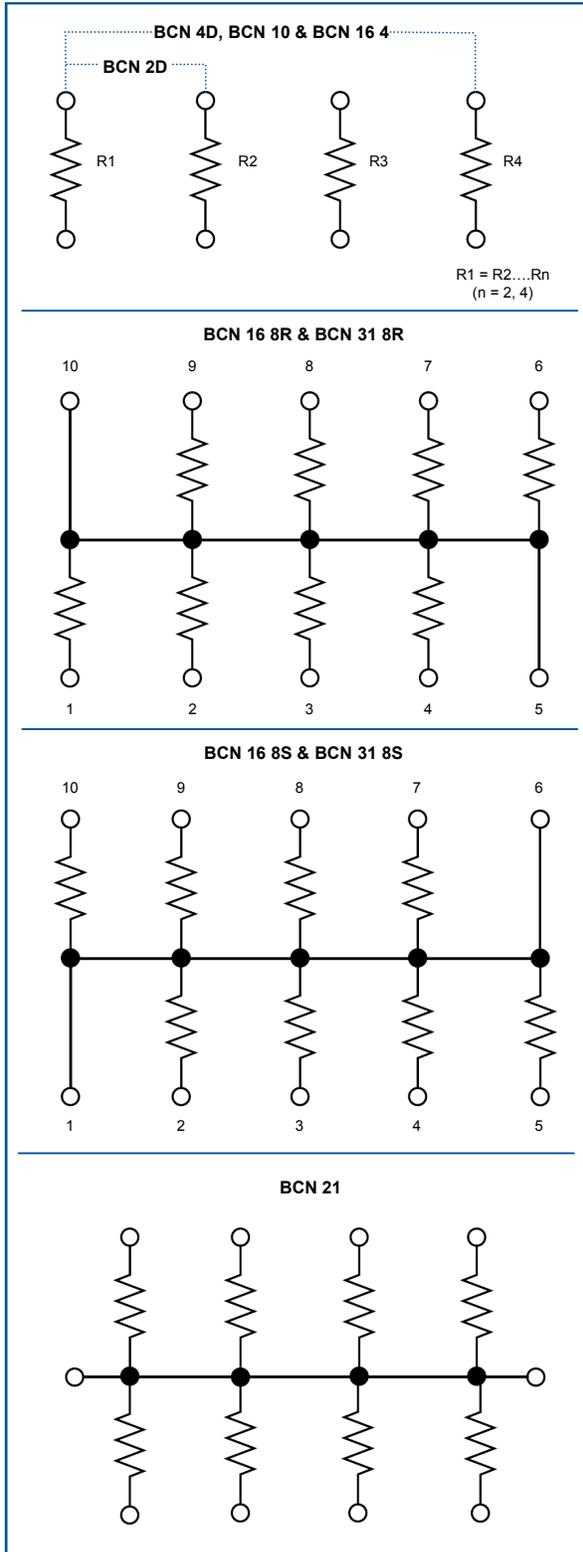

STANDARD RESISTANCE VALUES, OHMS

Model BCN 2D, BCN 4D, BCN 10 & BCN 16 4

10	100	1K	10K	100K	1 Meg
12	120	1.2K	12K	120K	Jumper
15	150	1.5K	15K	150K	
18	180	1.8K	18K	180K	
22	220	2.2K	22K	220K	
27	270	2.7K	27K	270K	
33	330	3.3K	33K	330K	
39	390	3.9K	39K	390K	
47	470	4.7K	47K	470K	
56	560	5.6K	56K	560K	
68	680	6.8K	68K	680K	
82	820	8.2K	82K	820K	

Model BCN 16 8R & BCN 16 8S

220	1K	10K	100K
330	4.7K	47K	1 Meg

Model BCN 31 8R

Model BCN 31 8S

220	2.2K	10K	100K
330	2.7K	22K	470K
1K	4.7K	47K	1 Meg

Model BCN 21

68	330	4.7K	10K
220	1K	47K	100K

General Note

BI Technologies reserves the right to make changes in product specification without notice or liability

© BI Technologies Limited • Glenrothes, Fife KY7 4NX, UK

Telephone: +44 (0) 1592 662200 • Facsimile: +44 (0) 1592 662299 • Website: www.bitechnologies.com • Email: sales@bitechnologies.co.uk

MODEL BCN SERIES

OUTLINE DIMENSIONS (Inch / mm)

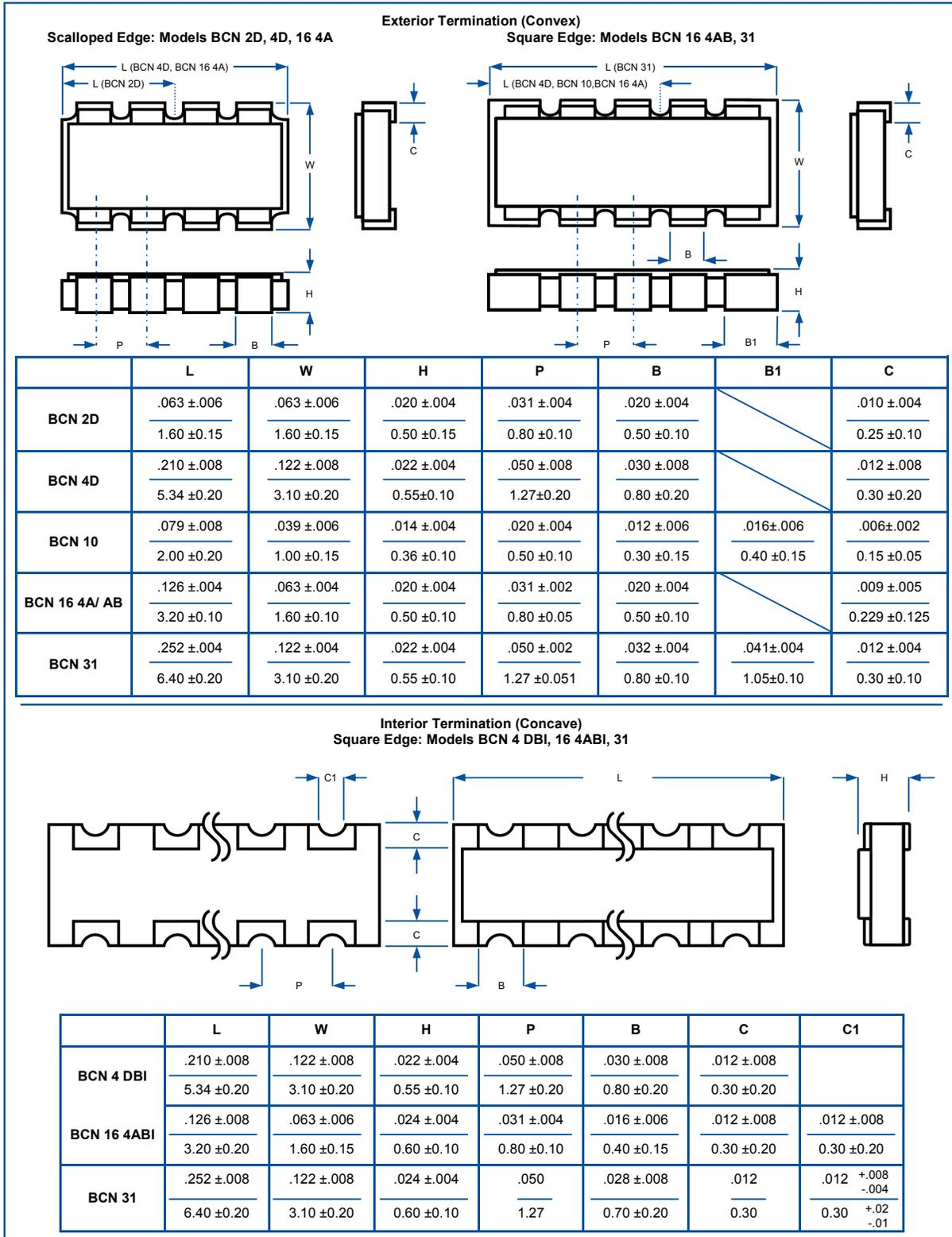

General Note

BI Technologies reserves the right to make changes in product specification without notice or liability

© BI Technologies Limited • Glenrothes, Fife KY7 4NX, UK
 Telephone: +44 (0) 1592 662200 • Facsimile: +44 (0) 1592 662299 • Website: www.bitechnologies.com • Email: sales@bitechnologies.co.uk

MODEL BCN SERIES

OUTLINE DIMENSIONS (Inch / mm)

Exterior Termination (Convex)
Square Edge: Models BCN 16 8R, 8S

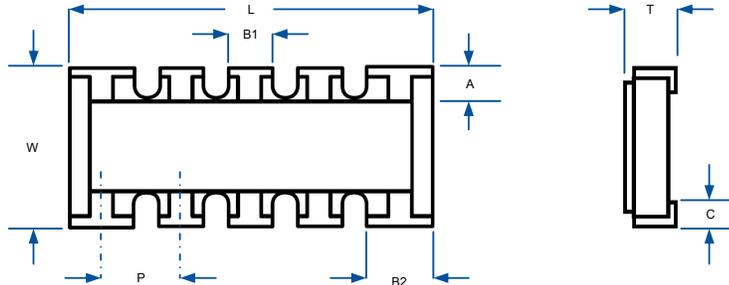

L	W	T	A	B1	B2	C	P
.126 ±.008	.063 ±.008	.020 ±.004	.012 ±.006	.014 ±.006	.020 ±.006	.008	.025
3.20 ±0.20	1.60 ±0.20	0.50 ±0.10	0.30 ±0.15	0.36 ±0.15	0.50 ±0.15	0.20	0.64

Exterior Termination (Convex)
Square Edge: Models BCN 16 8R, 8S

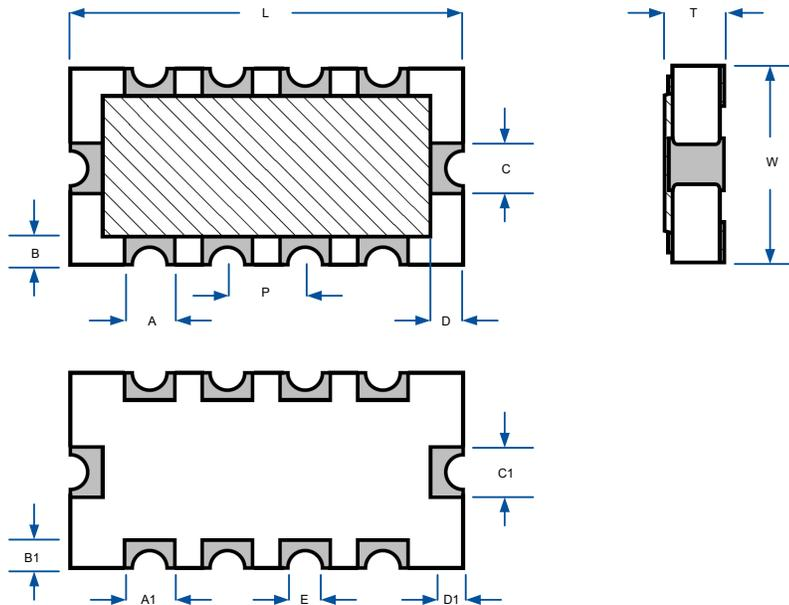

L	W	T	A	B	C	D
.157 ±.008	.083 ±.008	.021 ±.004	.020 ±.008	.010 ±.008	.020 ±.008	.012 ±.008
4.00 ±0.20	2.10 ±0.20	0.55 ±0.10	0.50 ±0.20	0.25 ±0.20	0.50 ±0.20	0.30 ±0.20
A1	B1	C1	D1	E	P	
.016 ±.008	.014 ±.008	.020 ±.008	.014 ±.008	.012	.032	
0.40 ±0.20	0.35 ±0.20	0.50 ±0.20	0.35 ±0.20	0.30	0.80	

General Note

BI Technologies reserves the right to make changes in product specification without notice or liability

© BI Technologies Limited • Glenrothes, Fife KY7 4NX, UK

Telephone: +44 (0) 1592 662200 • Facsimile: +44 (0) 1592 662299 • Website: www.bitechnologies.com • Email: sales@bitechnologies.co.uk



A subsidiary of TT electronics plc

BCN Series Issue Sep 2009

MODEL BCN SERIES

SOLDER PAD LAYOUT (Inch / mm)

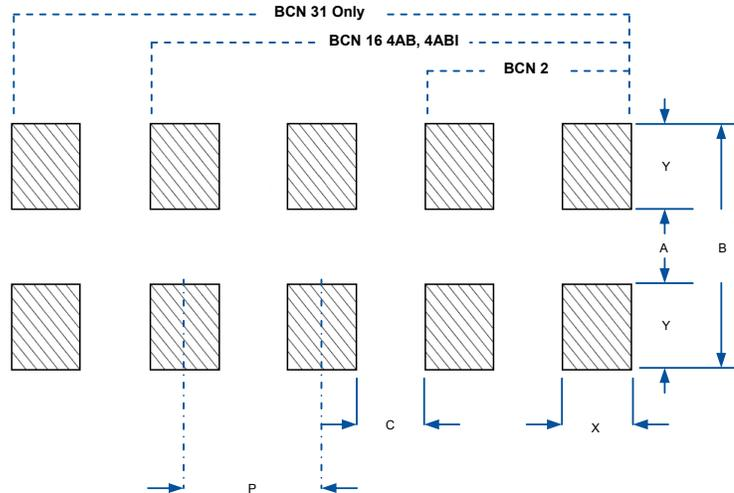

	Wave Solder Process						Re-flow Solder Process				
	P	A	B	C	X	Y	A	B	C	X	Y
BCN 2D	.032 0.80	.039 1.00	.102 2.60	.014 0.35	.018 0.45	.032 0.80	.039 1.00	.079 2.00	.014 0.35	.018 0.45	.020 0.50
BCN 4D/4DBI	.050 1.27	.087 2.20	.169 4.30	.022 0.57	.028 0.70	.041 1.05	.087 2.20	.154 3.90	.022 0.57	.028 0.70	.034 0.85
BCN 16 4A, AB, ABI	.032 0.80	.039 1.00	.118 3.00	.014 0.35	.018 0.45	.039 1.00	.039 1.00	.118 3.00	.014 0.35	.018 0.45	.039 1.00
BCN 31 8R, 8S	.050 1.27	.084 2.10	.148 3.70	.014 0.35	.036 0.90	.032 0.80	.084 2.10	.148 3.70	.014 0.35	.036 0.90	.032 0.80

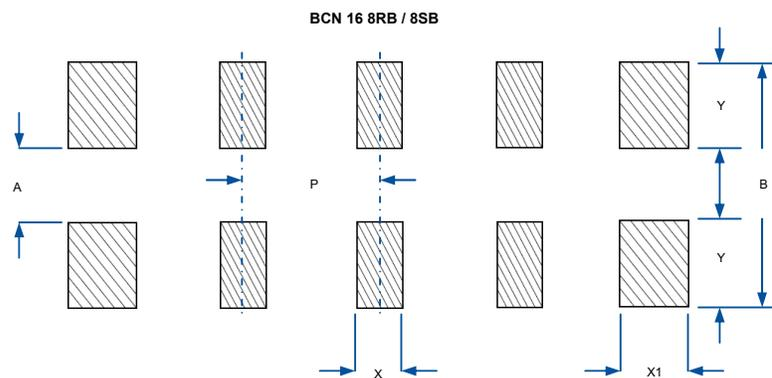

	Wave Solder Process						Re-flow Solder Process				
	P	A	B	X	X1	Y	A	B	X	X1	Y
BCN 16 8RB / 8SB	.025 0.64	.048 1.20	.096 2.40	.012 0.30	.018 0.45	.024 0.60	.048 1.20	.096 2.40	.012 0.30	.018 0.45	.024 0.60

General Note

BI Technologies reserves the right to make changes in product specification without notice or liability

© BI Technologies Limited • Glenrothes, Fife KY7 4NX, UK

Telephone: +44 (0) 1592 662200 • Facsimile: +44 (0) 1592 662299 • Website: www.bitechnologies.com • Email: sales@bitechnologies.co.uk

MODEL BCN SERIES

SOLDER PAD LAYOUT (Inch / mm)

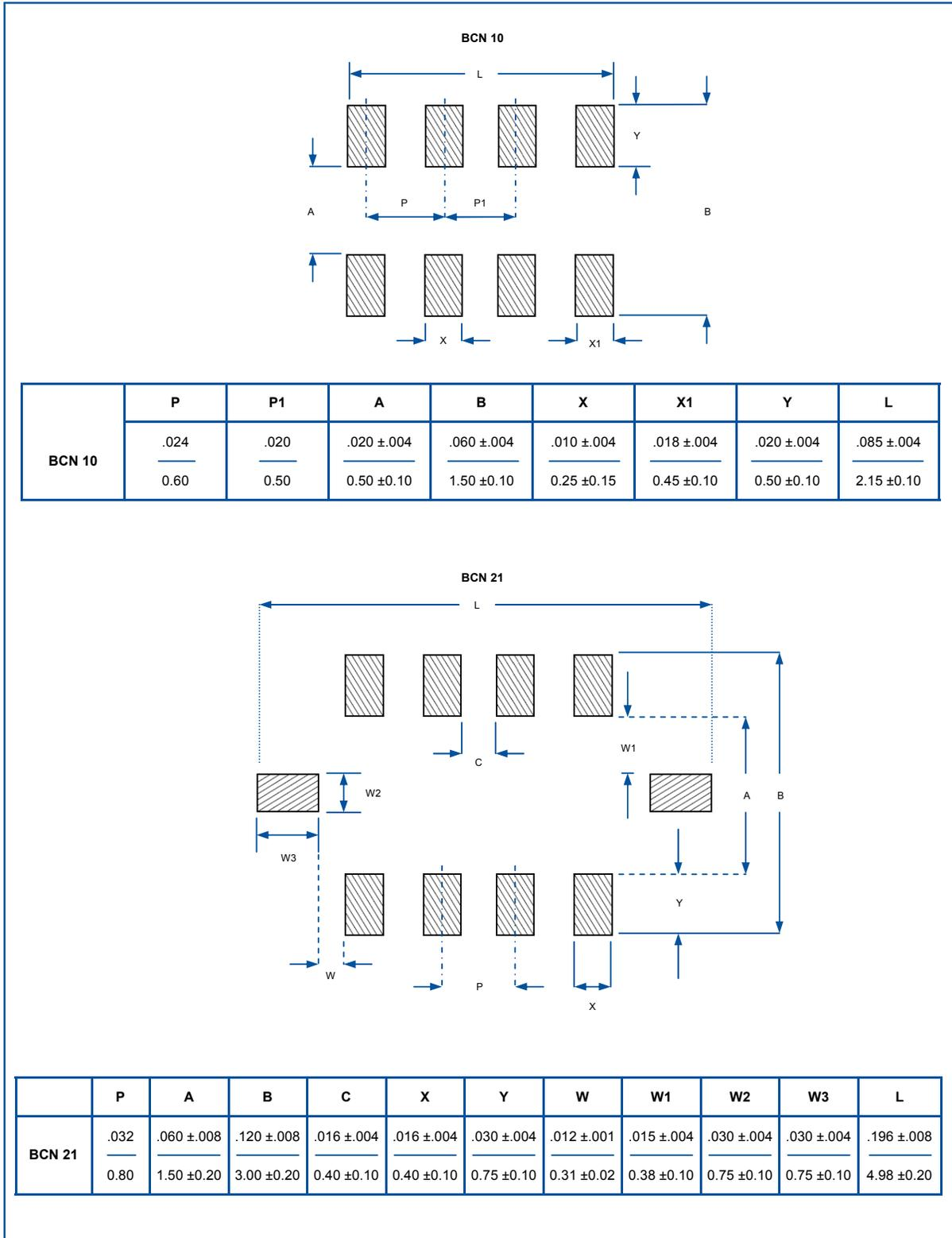

General Note

BI Technologies reserves the right to make changes in product specification without notice or liability

© BI Technologies Limited • Glenrothes, Fife KY7 4NX, UK

Telephone: +44 (0) 1592 662200 • Facsimile: +44 (0) 1592 662299 • Website: www.bitechnologies.com • Email: sales@bitechnologies.co.uk



A subsidiary of TT electronics plc

BCN Series Issue Sep 2009

MODEL BCN SERIES

ORDERING INFORMATION

<p>Model Series</p> <p>No. of Resistors:</p> <p>BCN 2D = 2 Resistors BCN 4D = 4 Resistors</p> <p>Circuit Configuration:</p> <p>D = Isolated</p> <p>Edge Option (B = Square Edge):</p> <p>BCN 2D: Scalloped Edge Only - No Code Used BCN 4D: Scalloped Edge Only - No Code Used</p>	<p>BCN</p> <p>4</p> <p>D</p> <p>B</p> <p>I</p> <p>102</p> <p>J</p> <p>7</p>	<p>Packaging Option: (See Table A)</p> <p>Tolerance: $\pm 5\%$</p> <p>Resistance Code</p> <p>Termination Code: I = Interior (Concave) Termination (Only available in BCN 4 DBI)</p>
--	---	--

See 'Model Styles' for Available Options

<p>Model Series</p> <p>Width:</p> <p>10 = 1.0mm 16 = 1.6mm 21 = 2.1mm 31 = 3.1mm</p> <p>No. of Resistors:</p> <p>BCN 10 = 4 Resistors BCN 16 4 = 4 Resistors BCN 16 8R / 8S = 8 Resistors BCN 21 = 8 Resistors BCN 31 8R / 8S = 8 Resistors</p> <p>Circuit Configuration:</p> <p>A = Isolated (BCN 10, 16 4A) R = Bussed (Reversed) (BCN 16 8R / 31 8R) S = Bussed (Standard) (BCN 21, 16 8S / 31 8S)</p>	<p>BCN</p> <p>16</p> <p>4</p> <p>A</p> <p>B</p> <p>I</p> <p>102</p> <p>J</p> <p>7</p>	<p>Packaging Option: (See Table A)</p> <p>Tolerance: F = $\pm 1\%$ (BCN 4D, 16 4, 31 8RB / 8SB) G = $\pm 2\%$ (BCN 16 4, 31 8RB / 8SB Only) J = $\pm 5\%$ (Standard) (Use JP for Jumper Chip Array - BCN 16 4, 31)</p> <p>Resistance Code: 3 digits for E4, E12, E24 Series, all Tol. 4 digits for E96 Series, 1% Tol.</p> <p>Termination Code: I = Interior (Concave) Termination No code used for exterior termination (Standard) All interior termination requires 'B' for square edge (BCN 16 4ABI, 31 8RBI / 8SBI)</p> <p>Edge Option (B = Square Edge): Scalloped Edge - No Code Used (Standard) Square Edge Only - Use Code 'B'</p>
---	--	---

See 'Model Styles' for Available Options

General Note

BI Technologies reserves the right to make changes in product specification without notice or liability

© BI Technologies Limited • Glenrothes, Fife KY7 4NX, UK

Telephone: +44 (0) 1592 662200 • Facsimile: +44 (0) 1592 662299 • Website: www.bitechnologies.com • Email: sales@bitechnologies.co.uk



A subsidiary of TT electronics plc

BCN Series Issue Sep 2009

MODEL BCN SERIES

MODEL STYLES

	7" Reel Diameter		13" Reel Diameter	
	Paper	Embossed	Paper	Embossed
BCN 2D	5K		20K	
BCN 4D		4K		16K
BCN 10	10K		40K	
BCN 16 4	5K		20K	
BCN 16 8	5K		20K	
BCN 21		4K		16K
BCN 31		4K		16K

Note: Tape & Reel dimensions per EIA-481.

General Note

BI Technologies reserves the right to make changes in product specification without notice or liability

© **BI Technologies Limited** • Glenrothes, Fife KY7 4NX, UK

Telephone: +44 (0) 1592 662200 • Facsimile: +44 (0) 1592 662299 • Website: www.bitechnologies.com • Email: sales@bitechnologies.co.uk



A subsidiary of TT electronics plc

BCN Series Issue Sep 2009