

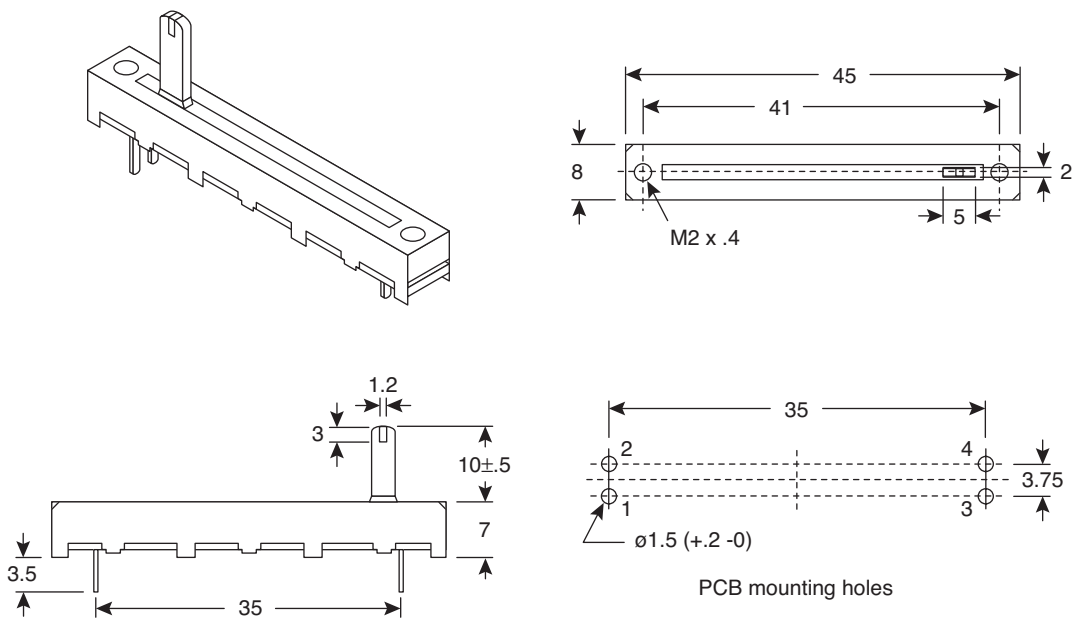

Potentiometer 312-319BF-Value



Dimensions (mm)

Specifications:

- Type: linear taper with white indicator
- Total resistance: 1K Ω ~1M Ω
- Resistance tolerance: $\pm 20\%$
- Rated wattage: 0.2
- Rated voltage: 200
- Insulation resistance: 100M Ω min. @ 250VDC
- Dielectric strength: 300VAC for 1 minute
- Operating force: 30~250gf.cm.
- Lever stop strength: 5kg/60sec.
(5mm point from mounting surface)
- Sliding life: 15,000 cycles
- Slide travel: 30mm
- Values (Ω): 1K, 5K, 10K, 50K, & 100K
- RoHS Compliant