



BOURNS®

Features

- Snap-in or bushing mount options
- Standard resistance values available
- Digital dial provides excellent readability

3610 - 10-Turn Precision Knobpot®

Electrical Characteristics¹

Standard Resistance Range.....	100 to 100 K ohms
Total Resistance Tolerance.....	±5 %
Effective Electrical Angle.....	3600 ° nominal
Absolute Minimum Resistance.....	1 ohm or 0.1 % maximum (whichever is greater)
Noise	100 ohms ENR maximum
Dielectric Withstanding Voltage (MIL-STD-202, Method 301)	
Sea Level	1,000 VAC minimum
70,000 Feet.....	400 VAC minimum
Power Rating (Voltage Limited By Power Dissipation or 385 VAC, Whichever is Less)	
+25 °C.....	1.5 watts
+85 °C.....	0 watt
Insulation Resistance (500 VDC).....	1,000 megohms minimum
Resolution	See recommended part numbers
Accuracy (Correlation of Dial Readout to Voltage Ratio Output)	±0.5 % voltage ratio
Repeatability of Dial Readout.....	±0.1 % voltage ratio

Environmental Characteristics¹

Operating Temperature Range	+1 °C to +85 °C
Storage Temperature Range	-25 °C to +85 °C
Temperature Coefficient Over Storage Temperature Range2	±50 ppm/°C maximum/wire
Vibration	10 G
Wiper Bounce.....	0.1 millisecond maximum
Total Resistance Shift	±2 % maximum
Voltage Ratio Shift	±0.2 % maximum
Shock	50 G
Wiper Bounce.....	0.1 millisecond maximum
Total Resistance Shift	±2 % maximum
Voltage Ratio Shift	±0.2 % maximum
Load Life.....	1,000 hours, 1.5 watts
Total Resistance Shift	±2 % maximum
Rotational Life (No Load)	50,000 shaft revolutions
Total Resistance Shift	±2 % maximum
Moisture Resistance (MIL-STD-202, Method 103, Condition B)	
Total Resistance Shift	±2 % maximum
IP Rating.....	IP 60

Mechanical Characteristics¹

Stop Strength	14 N-cm (20 oz.-in.) minimum
Mechanical Angle.....	3600 ° +20 °, -0 °
Torque (Starting)	0.71 to 4.94 N-cm (1.0 to 7.0 oz.-in.) maximum
Torque (Running)	4.94 N-cm (7.0 oz.-in.) maximum
Variation.....	0.71 N-cm (1.0 oz.-in.) maximum
Backlash.....	1.0 ° maximum
Weight	Approximately 20 gm
Terminals	Gold-plated J-Hooks
Soldering Condition	
Manual Soldering	96.5Sn/3.0Ag/0.5Cu solid wire or no-clean rosin cored wire; 370 °C (700 °F) max. for 3 seconds
Wave Soldering.....	96.5Sn/3.0Ag/0.5Cu solder with no-clean flux; 260 °C (500 °F) max. for 5 seconds
Wash processes	Not recommended
Markings.....	Manufacturer's name and part number, resistance value and tolerance, wiring diagram, and date code

¹At room ambient: +25 °C nominal and 50 % relative humidity nominal, except as noted.

Recommended Part Numbers

Part Number	Resistance (Ω)	Resolution (%)
3610S-1-102	1,000	.035
3610S-1-502	5,000	.027
3610S-1-103	10,000	.022

Part Number	Resistance (Ω)	Resolution (%)
3610S-2-102	1,000	.035
3610S-2-502	5,000	.027
3610S-2-103	10,000	.022

BOLDFACE LISTINGS ARE IN STOCK AND READILY AVAILABLE THROUGH DISTRIBUTION.

FOR OTHER OPTIONS AND RESISTANCE VALUES, PLEASE CONSULT THE FACTORY.

"Knobpot" is a registered trademark of Bourns, Inc. Specifications are subject to change without notice. Customers should verify actual device performance in their specific applications.

3610 - 10-Turn Precision Knobpot®

BOURNS®

Product Dimensions

3610S-1

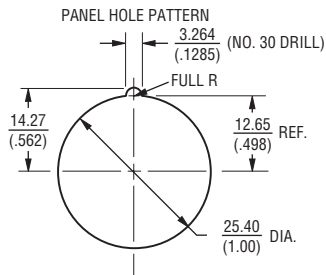

- NOTES:
 1. SNAP-IN MOUNTING CUP ACCOMMODATES PANEL THICKNESS
 $\frac{.64}{.025}$ THRU $\frac{1.98}{.078}$ (NO. 22GA)
 THRU NO. 14GA) AND $\frac{3.18}{.125}$

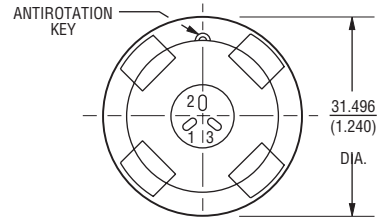
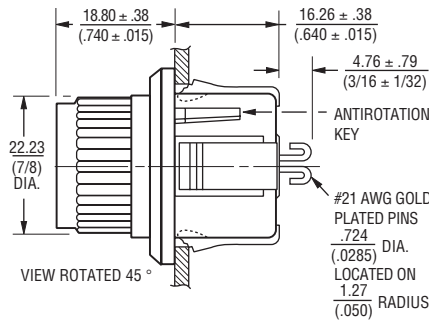

3610S-2

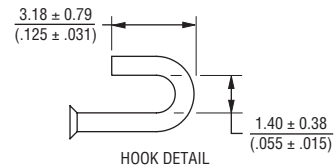
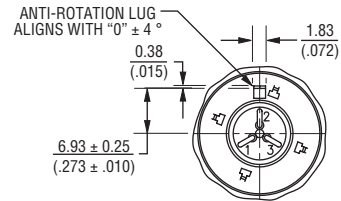
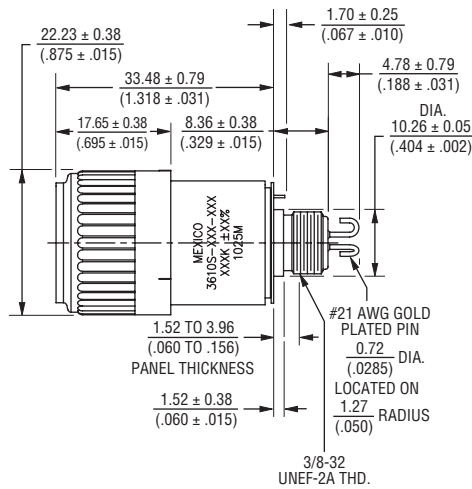
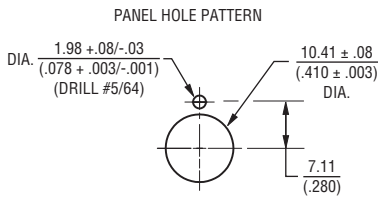

TOLERANCES: EXCEPT WHERE NOTED
 DECIMALS: .XX ± $\frac{.25}{.010}$, .XXX ± $\frac{.13}{.005}$
 FRACTIONS: ±1/64
 DIMENSIONS: $\frac{MM}{(IN.)}$

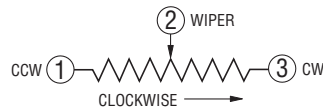

REV. 08/10

Specifications are subject to change without notice.
 Customers should verify actual device performance in their specific applications.