

Features

- Single gang panel control
- RoHS compliant*
- Carbon element
- Center detent option
- Wide range of resistance tapers
- Insulated shaft styles
- Assortment of pin layouts

Applications

- Audio/TV sets
- Car radio
- Amplifiers/mixers/drum machines/synthesizers
- PCs/monitors
- Appliances

PDB12 Series - 12 mm Rotary Potentiometer

Electrical Characteristics

Taper..... Linear, audio
 Standard Resistance Range
 1K ohms to 1M ohms
 Standard Resistance Tolerance..... ±20 %
 Residual Resistance..... 10 ohms max.

Environmental Characteristics

Power Rating
 Linear 0.08 watt
 Audio..... 0.04 watt
 Maximum Operating Voltage
 Linear 150 V
 Audio..... 100 V
 Sliding Noise 47 mV max.

Mechanical Characteristics

Mechanical Angle 300 ° ±5 °
 Rotational Torque 20 to 200 g-cm
 Stop Strength 3 kg-cm min.
 Rotational Life 15,000 cycles
 Soldering Condition
 300 °C max. within 3 seconds
 Hardware No hardware supplied

Derating Curve

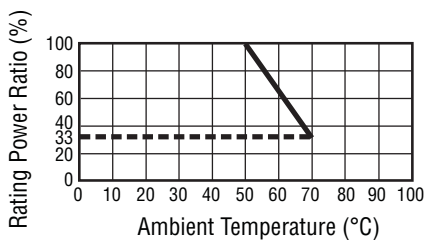

Product Dimensions

PDB12-H

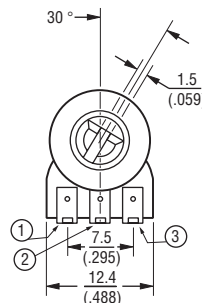
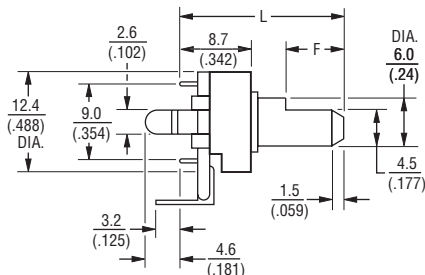

RECOMMENDED PCB LAYOUT

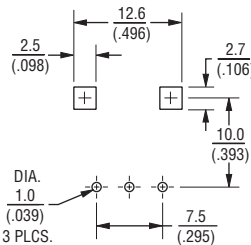

SHAFT SHOWN IN CCW POSITION

PDB12-G

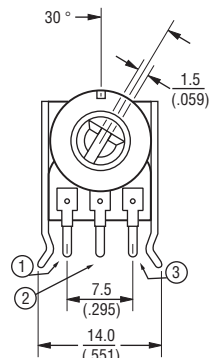
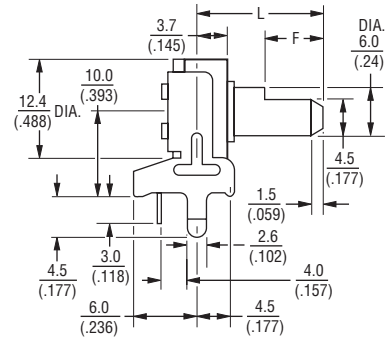

RECOMMENDED PCB LAYOUT

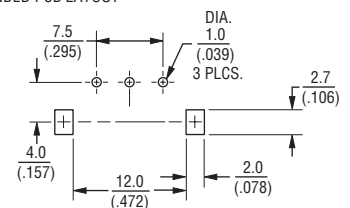

SHAFT SHOWN IN CCW POSITION

PDB12 Dimensions

L	15 (.591)	20 (.787)	25 (.984)	30 (1.181)
F	7 (.276)	7 (.276)	12 (.472)	12 (.472)

DIMENSIONS: $\frac{\text{MM}}{\text{(INCHES)}}$

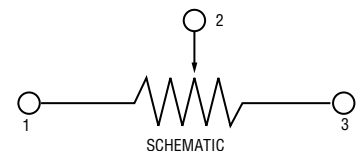

*RoHS Directive 2002/95/EC Jan 27, 2003 including Annex.
 Specifications are subject to change without notice.
 Customers should verify actual device performance in their specific applications

PDB12 Series - 12 mm Rotary Potentiometer

BOURNS®

Product Dimensions

PDB12-M

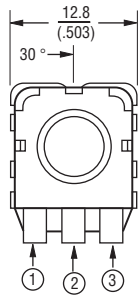
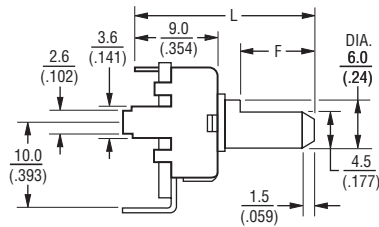

RECOMMENDED PCB LAYOUT

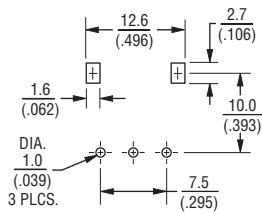

SHAFT SHOWN IN CCW POSITION

DIMENSIONS: $\frac{\text{MM}}{\text{(INCHES)}}$

PDB12-F

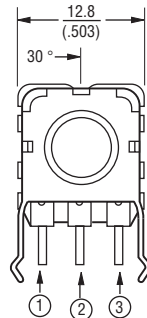
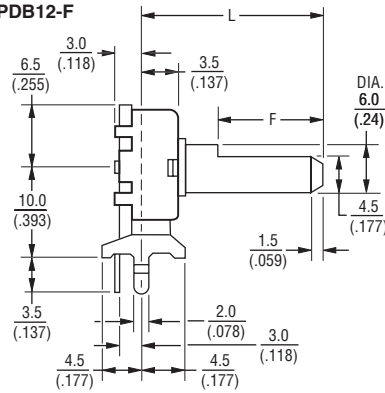

RECOMMENDED PCB LAYOUT

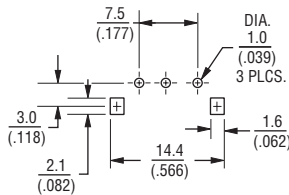

SHAFT SHOWN IN CCW POSITION

How To Order

PDB12 - H 4 20 1 - 103 A F

Model

Terminal Config. (see individual drawings)
 H = PC pins, rear facing snap mount
 G = PC pins, vertical/down facing snap mount
 M = PC pins, rear facing
 F = PC pins, vertical/down facing snap mount

Option
 • 2 = Center Detent
 • 4 = No Detent

Standard Shaft Length
 • 15 = 15 mm
 • 20 = 20 mm
 • 25 = 25 mm
 • 30 = 30 mm

Number of Gangs
 • 1 = Single Gang

Resistance Code (See Table)

Resistance Taper
 • A = Audio Taper
 • B = Linear Taper

Shaft Style
 • F = Flat Type Insulated Shaft

Other styles available.

Standard Resistance Table

Resistance (Ohms)	Resistance Code
1,000	102
2,000	202
5,000	502
10,000	103
20,000	203
50,000	503
100,000	104
200,000	204
500,000	504
1,000,000	105

PDB12 Dimensions

	15 (.591)	20 (.787)	25 (.984)	30 (1.181)
L				
F	7 (.276)	7 (.276)	12 (.472)	12 (.472)

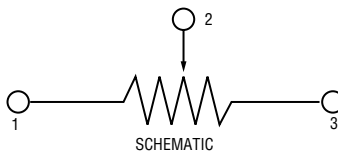

REV. 01/11

Specifications are subject to change without notice.
 Customers should verify actual device performance in their specific applications