

### Features

- 0603 size
- Magnetic shielding
- High Q characteristics
- Nickel barrier
- Lead free

### Applications

- Prevention of electromagnetic interference to signals on the secondary side of electronic equipment

## CS160808 Series - Ferrite Multi-Layer Chip Inductors

### Electrical Specifications

Bourns Part No.	Inductance		Q	Test Freq.	SRF MHz		DCR	I rms
	μH	Tol. %	typ.	L,Q MHz	min.	typ.	mΩ max.	mA max.
CS160808-47NK	0.047	±10	45	50	260	320	150	200
CS160808-68NK	0.068	±10	45	50	250	290	200	200
CS160808-82NK	0.082	±10	45	50	245	280	250	200
CS160808-R10K	0.10	±10	30	25	240	270	250	200
CS160808-R12K	0.12	±10	30	25	205	260	300	200
CS160808-R15K	0.15	±10	30	25	180	250	350	200
CS160808-R18K	0.18	±10	30	25	165	220	400	200
CS160808-R22K	0.22	±10	30	25	150	200	400	200
CS160808-R27K	0.27	±10	30	25	136	190	500	200
CS160808-R33K	0.33	±10	30	25	125	180	550	150
CS160808-R39K	0.39	±10	30	25	110	170	600	150
CS160808-R47K	0.47	±10	30	25	105	160	700	150
CS160808-R56K	0.56	±10	30	25	95	150	900	150
CS160808-R68K	0.68	±10	30	25	80	140	900	150
CS160808-R82K	0.82	±10	30	25	75	130	1400	100
CS160808-1R0K	1.0	±10	50	10	70	95	500	100
CS160808-1R2K	1.2	±10	50	10	60	80	600	100
CS160808-1R5K	1.5	±10	50	10	55	70	650	50
CS160808-1R8K	1.8	±10	50	10	50	70	750	50
CS160808-2R2K	2.2	±10	50	10	45	60	900	50
CS160808-2R7K	2.7	±10	50	10	40	55	1000	50

### General Specifications

Temperature Rise .....20 °C max. at rated current  
 Operating Temperature .....-55 °C to +125 °C  
 Storage Temperature .....-55 °C to +125 °C  
 Reflow Soldering ...230 °C, 50 sec. max.  
 Resistance to Soldering Heat .....260 °C, 10 seconds

### Materials

Base Material .....Ferrite  
 Terminal .....Ag/Ni/Sn  
 Packaging .....4,000 pcs. per reel

### Product Dimensions

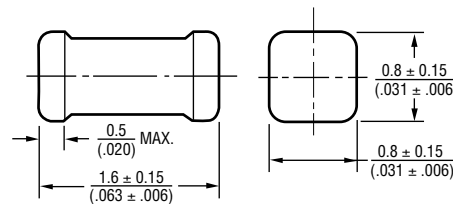

DIMENSIONS:  $\frac{\text{MM}}{\text{(INCHES)}}$

### Packaging Specifications

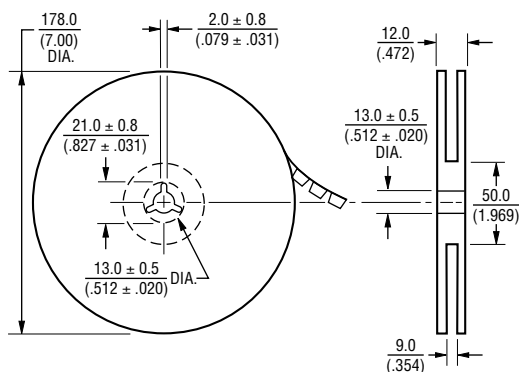

### Recommended Layout

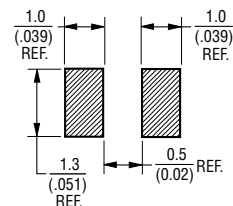

\*RoHS Directive 2002/95/EC Jan 27 2003 including Annex  
 Specifications are subject to change without notice.  
 Customers should verify actual device performance in their specific applications.

# CS160808 Series - Ferrite Multi-Layer Chip Inductors **BOURNS®**

## Electrical Specifications

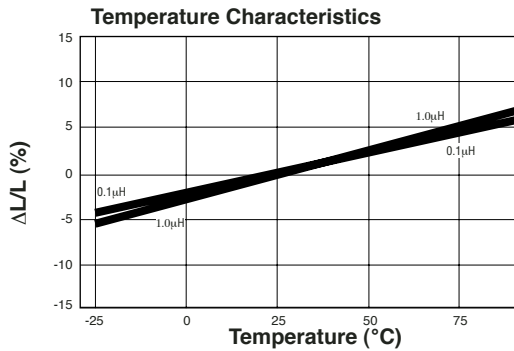
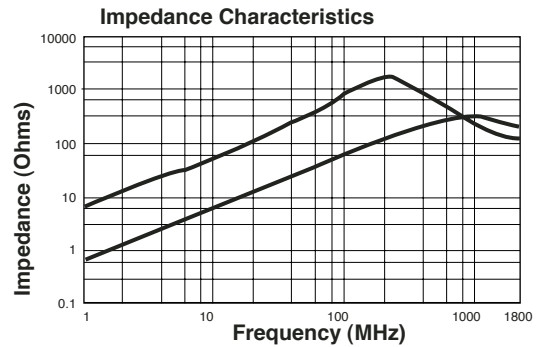
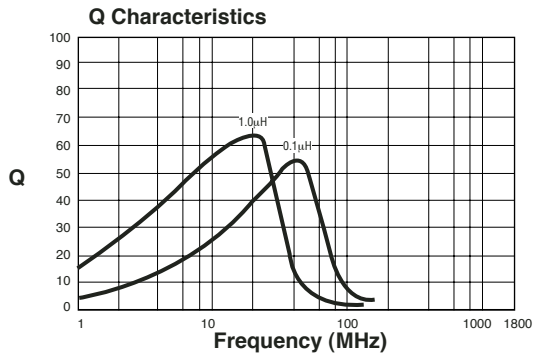
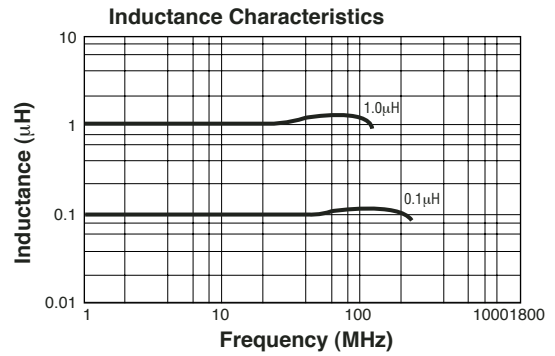
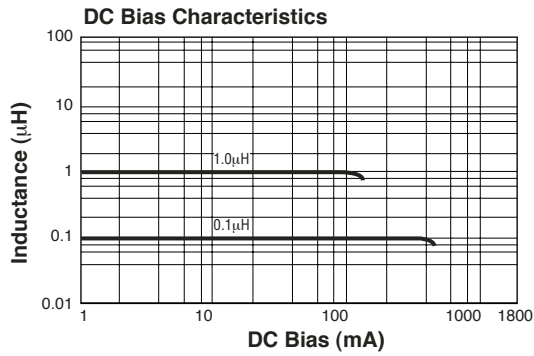

REV. 05/05

Specifications are subject to change without notice.  
Customers should verify actual device performance in their specific applications.