

### Features

- 1206 size
- Magnetic shielding
- High Q characteristics
- Nickel barrier
- Lead free

### Applications

- Prevention of electromagnetic interference to signals on the secondary side of electronic equipment

**BOURNS®**

## CS321613 Series - Ferrite Multi-Layer Chip Inductors

### Electrical Specifications

Bourns Part No.	Inductance		Q	Test Freq.	SRF MHz		DCR	I rms
	μH	Tol.%			typ.	L,Q MHz		
CS321613-47NK	0.047	±10	60	50	320	400	150	300
CS321613-68NK	0.068	±10	60	50	280	350	150	300
CS321613-R10K	0.10	±10	50	25	235	300	200	250
CS321613-R12K	0.12	±10	50	25	220	280	200	250
CS321613-R15K	0.15	±10	50	25	200	250	200	250
CS321613-R18K	0.18	±10	50	25	185	230	200	250
CS321613-R22K	0.22	±10	50	25	170	220	250	250
CS321613-R27K	0.27	±10	50	25	150	200	250	250
CS321613-R33K	0.33	±10	50	25	145	180	300	250
CS321613-R39K	0.39	±10	50	25	135	170	300	200
CS321613-R47K	0.47	±10	50	25	125	160	300	200
CS321613-R56K	0.56	±10	50	25	115	150	350	150
CS321613-R68K	0.68	±10	50	25	105	135	350	150
CS321613-R82K	0.82	±10	50	25	100	125	400	150
CS321613-1R0K	1.0	±10	80	10	75	105	250	100
CS321613-1R2K	1.2	±10	80	10	65	95	300	100
CS321613-1R5K	1.5	±10	80	10	60	85	300	50
CS321613-1R8K	1.8	±10	80	10	55	75	500	50
CS321613-2R2K	2.2	±10	80	10	50	70	600	50
CS321613-2R7K	2.7	±10	80	10	45	65	600	50
CS321613-3R3K	3.3	±10	85	10	40	55	700	50
CS321613-3R9K	3.9	±10	85	10	38	50	800	50
CS321613-4R7K	4.7	±10	85	10	35	48	800	50
CS321613-5R6K	5.6	±10	65	4	32	45	600	25
CS321613-6R8K	6.8	±10	65	4	29	40	600	25
CS321613-8R2K	8.2	±10	65	4	26	36	600	25
CS321613-100K	10.0	±10	65	2	24	33	700	25
CS321613-120K	12.0	±10	65	2	22	30	900	25
CS321613-150K	15.0	±10	45	1	19	27	1100	25
CS321613-180K	18.0	±10	45	1	18	25	1400	25
CS321613-220K	22.0	±10	45	1	16	22	1400	25
CS321613-270K	27.0	±10	45	1	14	20	1500	25
CS321613-330K	33.0	±10	45	0.4	13	18	1500	25

### General Specifications

Temperature Rise .....20 °C max. at rated current  
 Operating Temperature .....-55 °C to +125 °C  
 Storage Temperature .....-55 °C to +125 °C  
 Reflow Soldering ...230 °C, 50 sec. max.  
 Resistance to Soldering Heat .....260 °C, 10 seconds

### Materials

Base Material .....Ferrite  
 Terminal .....Ag/Ni/Sn  
 Packaging .....3,000 pcs. per reel

### Product Dimensions

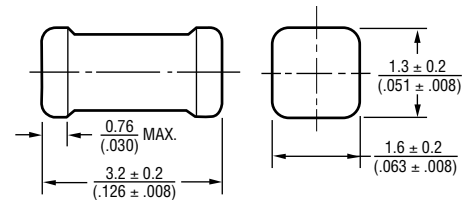

DIMENSIONS:  $\frac{\text{MM}}{\text{(INCHES)}}$

### Recommended Layout

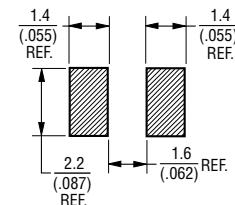

### Packaging Specifications

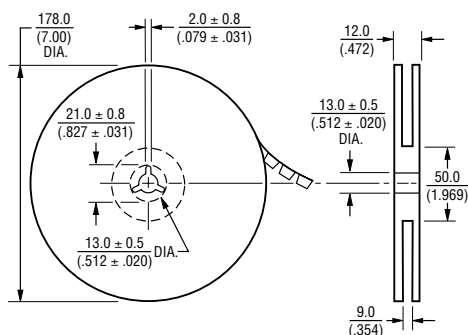

\*RoHS Directive 2002/95/EC Jan 27 2003 including Annex Specifications are subject to change without notice. Customers should verify actual device performance in their specific applications.

# CS321613 Series - Ferrite Multi-Layer Chip Inductors **BOURNS®**

## Electrical Specifications

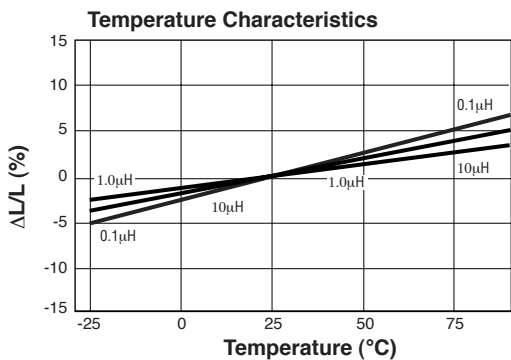
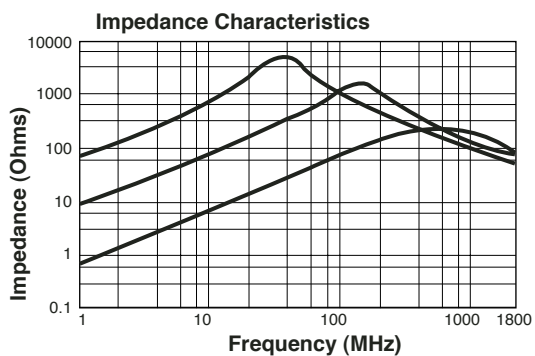
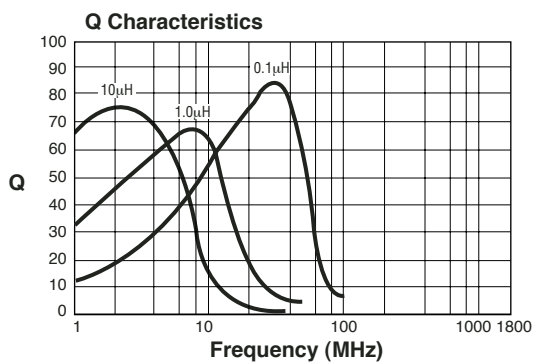
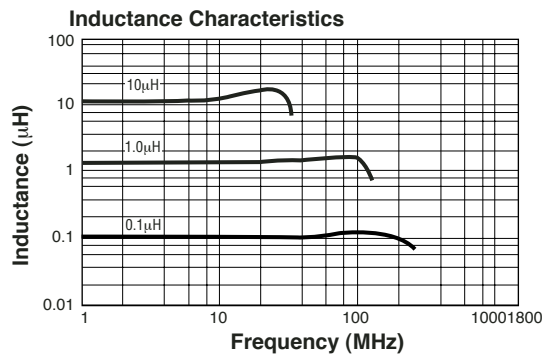
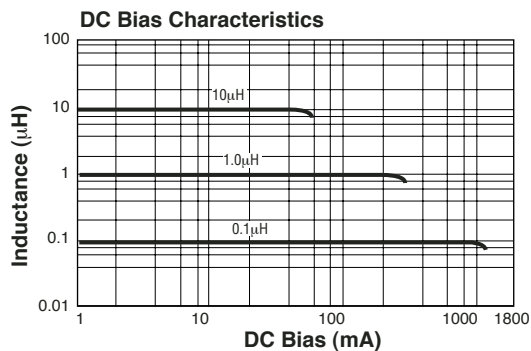

REV. 08/05

Specifications are subject to change without notice.  
Customers should verify actual device performance in their specific applications.