

**Features**

- For DCS applications
- Usable bandwidth 75 MHz
- Low loss
- No impedance matching required for operation at 50 Ω
- Single-ended operation
- Ceramic Surface Mount Package (SMP)
- Hermetic
- RoHS compliant (2002/95/EC), Pb-free 

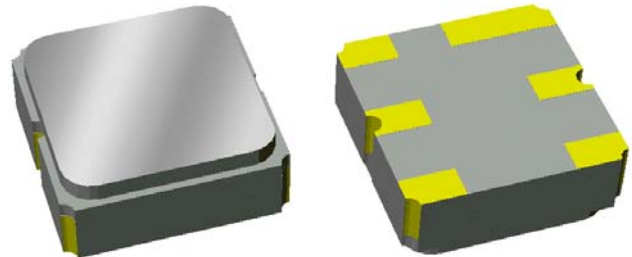

**Package**

Surface Mount 3.00 x 3.00 x 1.22 mm

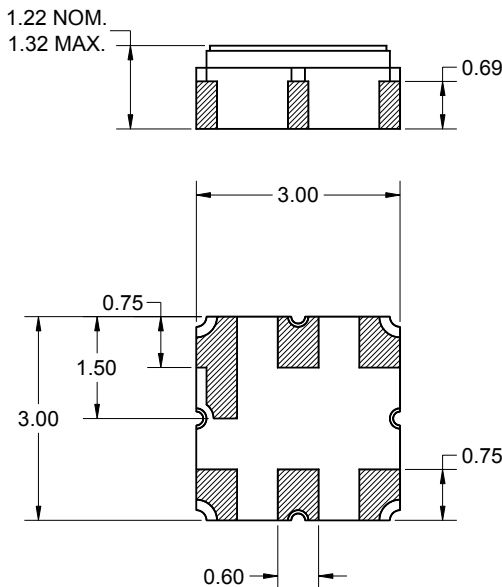

Dimensions shown are nominal in millimeters  
All tolerances are  $\pm 0.15$ mm except overall length and width  $\pm 0.10$ mm

Body:  $Al_2O_3$  ceramic  
Lid: Kovar, Ni plated  
Terminations: Au plating 0.5 - 1.0  $\mu$ m,  
over a 2 - 6  $\mu$ m Ni plating

**Pin Configuration**

Bottom View

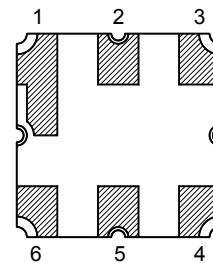

Pin No.	Description
2,5	Input/Output
1,3,4,6	Case ground

**Electrical Specifications <sup>(1)</sup>**

Operating Temperature Range: <sup>(2)</sup> -40 to +85 °C

Parameter <sup>(3)</sup>	Minimum	Typical	Maximum	Unit
<b>Center Frequency</b>	-	1842.5	-	MHz
<b>Maximum Insertion Loss</b>				
1805 - 1815 MHz (+15 to +85 °C)	-	2.8	3.4	dB
1805 - 1815 MHz (-40 to +15 °C)	-	-	4.8	dB
1815 - 1870 MHz	-	1.9	3.2	dB
1870 - 1880 MHz	-	2.1	4.8	dB
<b>Absolute Attenuation</b>				
10 - 1720 MHz	20	23	-	dB
1720 - 1765 MHz	25	29	-	dB
1765 - 1785 MHz	10	23	-	dB
1920 - 1980 MHz	15	27	-	dB
1980 - 2410 MHz	17	24	-	dB
2410 - 3120 MHz	20	24	-	dB
3120 - 4000 MHz	17	25	-	dB
<b>Input/Output Return Loss</b>				
1805 - 1880 MHz	6	9.2	-	dB
<b>Source Impedance <sup>(4)</sup></b>	-	50	-	Ω
<b>Load Impedance <sup>(4)</sup></b>	-	50	-	Ω

**Notes:**

1. All specifications are based on the test circuit shown below
2. In production, devices will be tested at room temperature to a guardbanded specification to ensure electrical compliance over temperature
3. Electrical margin has been built into the design to account for the variations due to temperature drift and manufacturing tolerances
4. This is the optimum impedance in order to achieve the performance shown

**Test Circuit:**

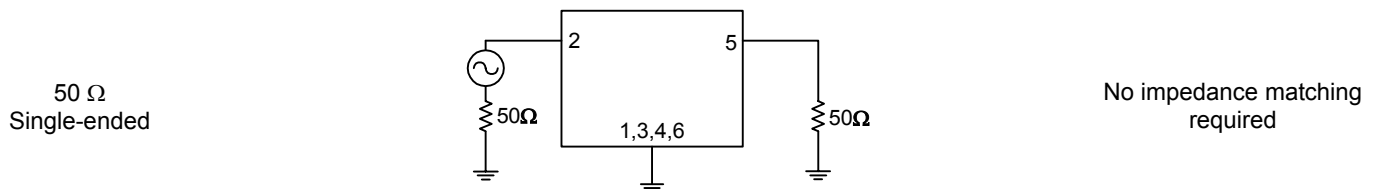

**Typical Performance (at +25°C)**

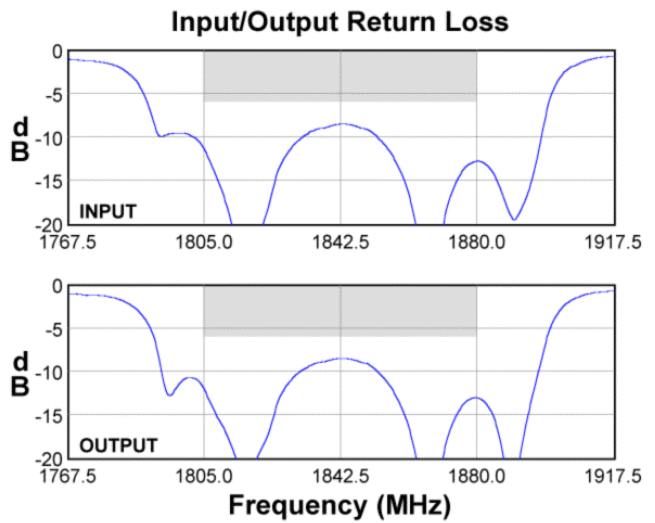
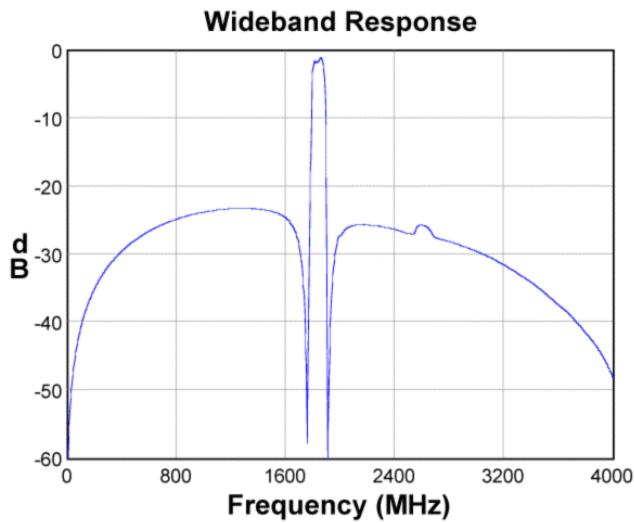
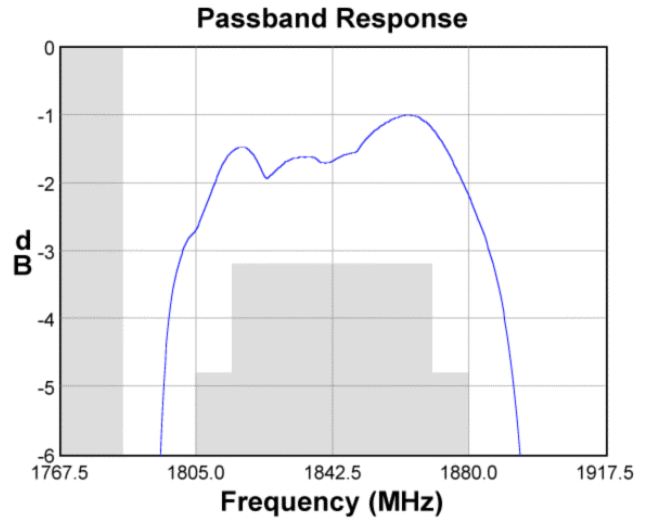
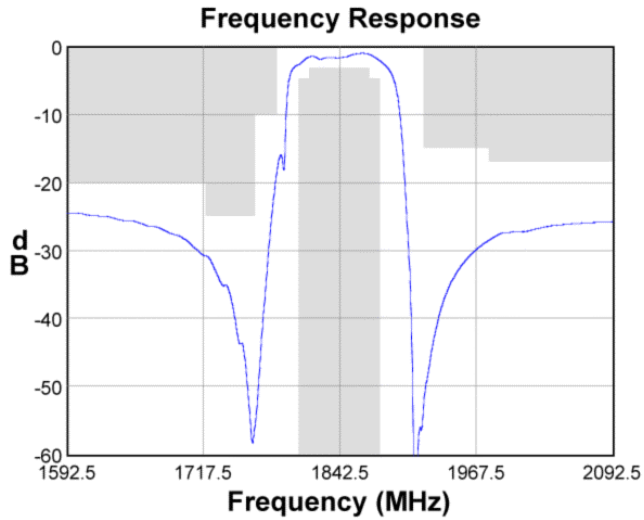

**Input Smith Chart**

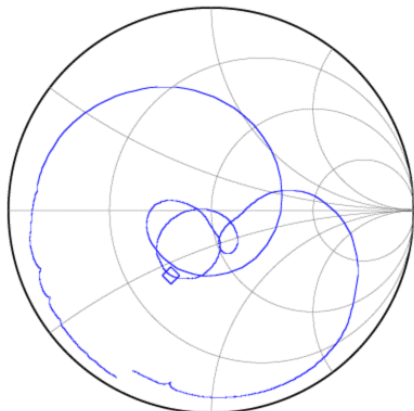

**Output Smith Chart**

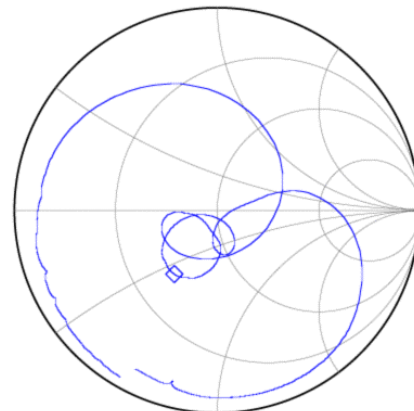

**Matching Schematics**

50 Ω  
Single-ended

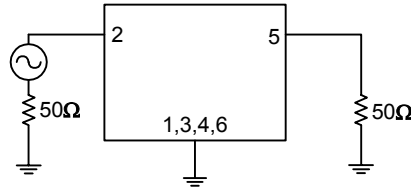

No impedance matching required

**Marking**

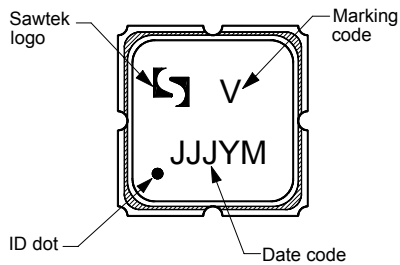

The date code consists of: JJJ = Julian day,  
Y = last digit of year, M = manufacturing site code

**PCB Footprint**

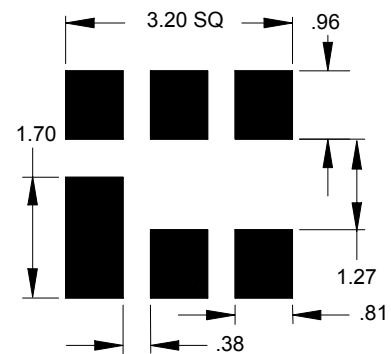

This footprint represents a recommendation only  
Dimensions shown are nominal in millimeters

**Tape and Reel**

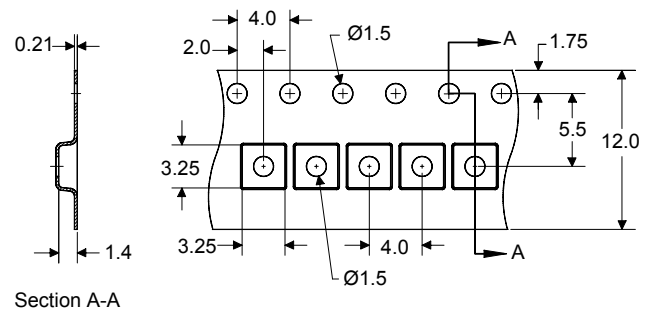
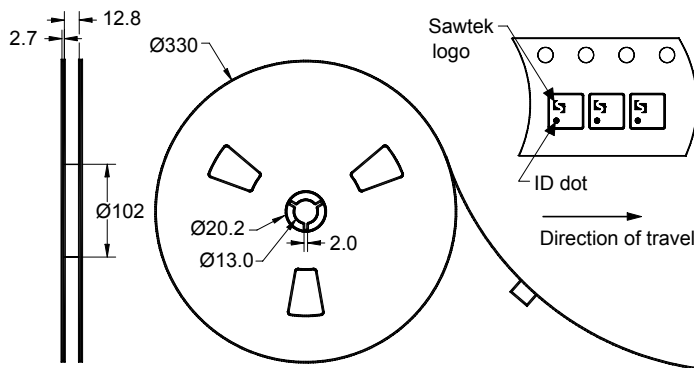

Dimensions shown are nominal in millimeters  
Packaging quantity: 5000 units/reel

**Data Sheet**

**Maximum Ratings**

Parameter	Symbol	Minimum	Maximum	Unit
Operating Temperature Range	T	-40	+85	°C
Storage Temperature Range	T <sub>stg</sub>	-40	+85	°C
RF Power	P <sub>in</sub>	-	+13	dBm

**Important Notes**

**Warnings**

- Electrostatic Sensitive Device (ESD) 
- Avoid ultrasonic exposure

**RoHS Compliance**

- This product complies with EU directive 2002/95/EC (RoHS) 

**Solderability**

- Compatible with JEDEC J-STD-020C **Pb-free** process, **260°C** peak reflow temperature ([see soldering profile](#))

**Links to Additional Technical Information**

[PCB Layout Tips](#)

[Qualification Flowchart](#)

[Soldering Profile](#)

[S-Parameters](#)

[RoHS Information](#)

[Other Technical Information](#)

TriQuint's liability is limited only to the Surface Acoustic Wave (SAW) component(s) described in this data sheet. TriQuint does not accept any liability for applications, processes, circuits or assemblies, which are implemented using any TriQuint component described in this data sheet.

**Contact Information**



PO Box 609501  
Orlando, FL 32860-9501  
USA

Phone: +1 (407) 886-8860  
Fax: +1 (407) 886-7061  
Email: [custservice@tqs.com](mailto:custservice@tqs.com)  
Web: [www.triquint.com](http://www.triquint.com)

Or contact one of our worldwide  
Network of [sales offices](#),  
[Representatives or distributors](#)