



- 310.0 to 319.5 MHz Filter
- Optimized for use with the TRC105 Transceiver
- Balanced 150 ohm IC Interface
- Complies with Directive 2002/95/EC (RoHS) 

RF3603D

**316.4 MHz
SAW Filter**

Absolute Maximum Ratings

Rating	Value	Units
Input Power Level	+15	dBm
DC Voltage	±5	V
Operating Temperature Range	-40 to +85	°C
Storage Temperature Range in Tape and Reel	-40 to +85	°C
Maximum Soldering Profile, 5 cycles/ 10 seconds maximum	265	°C

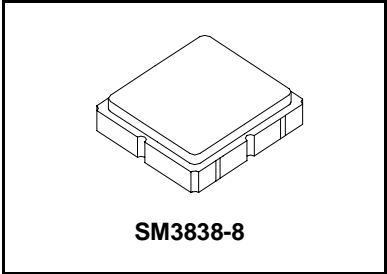

Electrical Characteristics

Characteristic	Sym	Notes	Min	Typ	Max	Units
Center Frequency	f_C			316.4		MHz
1 dB Bandwidth	BW_1			13		MHz
Maximum Insertion Loss, 310.0 to 319.5 MHz	IL_{MAX}			1.8	2.2	dB
Amplitude Ripple, p-p, 310.0 to 319.5 MHz					1.0	
Rejection Referenced to Insertion Loss at 315.0 MHz:						
DC to 306 MHz			37	40		
336 to 366 MHz			18	21		
366 to 966 MHz			52	55		
966 to 1266 MHz			46	49		
1266 to 2000 MHz			28	31		
Source Impedance	Z_S			50		Ω
Balanced Load Impedance	Z_L			150		Ω

Case Style	SM3838-8 3.8 x 3.8 mm Nominal Footprint		
Lid Symbolization (Y=year, WW=week, S=shift) dot=pin 1 indicator	886, YWWS		
Standard Reel Quantity	Reel Size 7 Inch	500 Pieces/Reel	
	Reel Size 13 Inch	3000 Pieces/Reel	

Electrical Connections

Connection	Terminals
Single-ended Port	6
Balanced Port	1, 3
Case Ground	4, 5, 7, 8
No Connection	2



CAUTION: Electrostatic Sensitive Device. Observe precautions for handling.

Notes:

1. Unless noted otherwise, all specifications apply over the operating temperature range with filter soldered to the specified demonstration board with impedance matching to 50 Ω and measured with 50 Ω network analyzer.
2. Unless noted otherwise, all frequency specifications are referenced to the nominal center frequency, f_C .
3. Rejection is measured as attenuation below the minimum IL point in the passband. Rejection in final user application is dependent on PCB layout and external impedance matching design. See Application Note No. 42 for details.
4. The design, manufacturing process, and specifications of this filter are subject to change.
5. US and international patents may apply.
6. RFM, stylized RFM logo, and RF Monolithics, Inc. are registered trademarks of RF Monolithics, Inc.

RF3603D-TRC105 Application Circuit

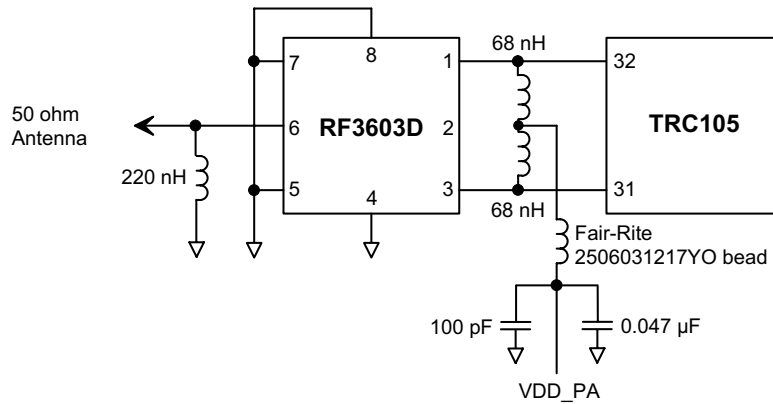

RF3603D 50 Ohm Tuning Network

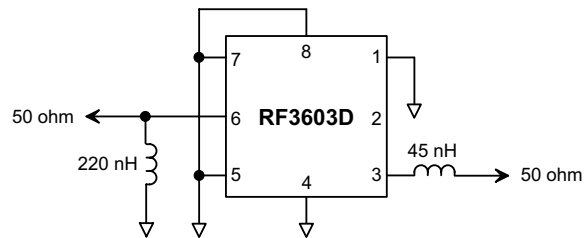

RF3603D Broadband Response, 200 to 2000 MHz

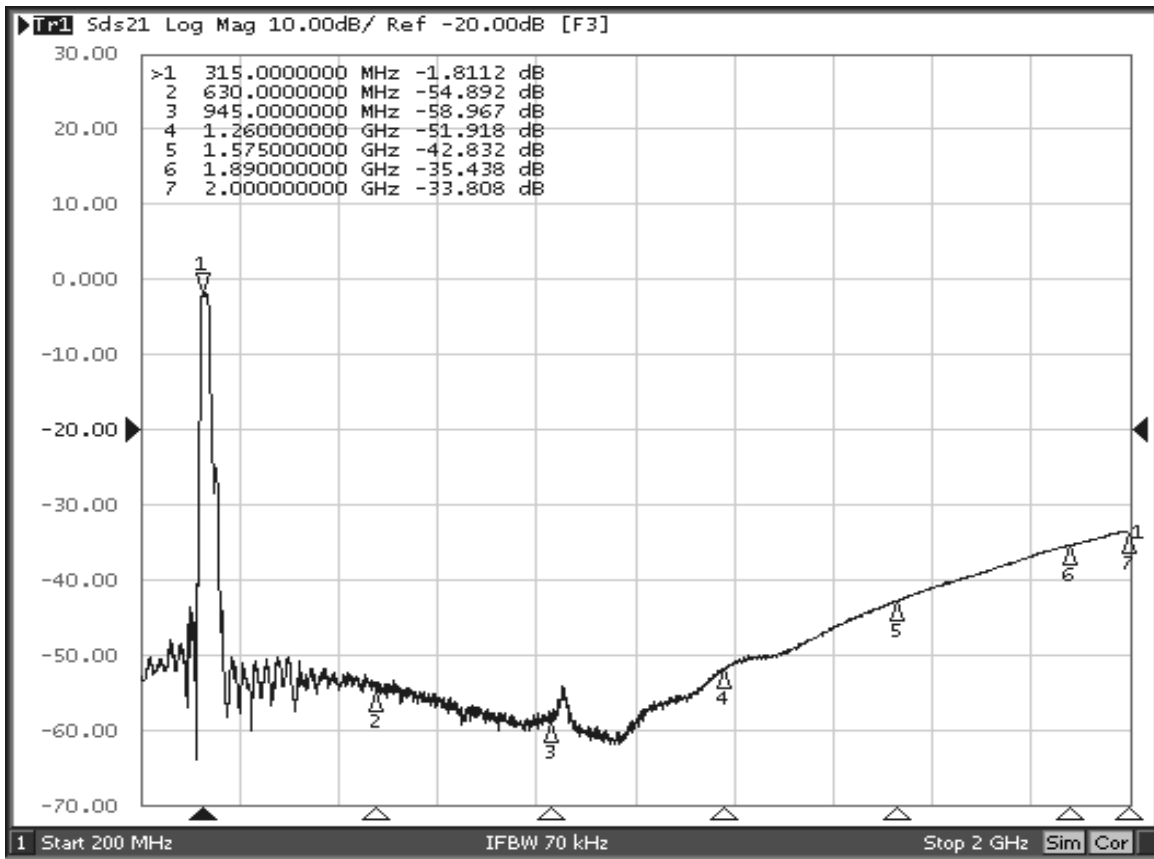

RF3603D Response, 216.4 to 416.4 MHz

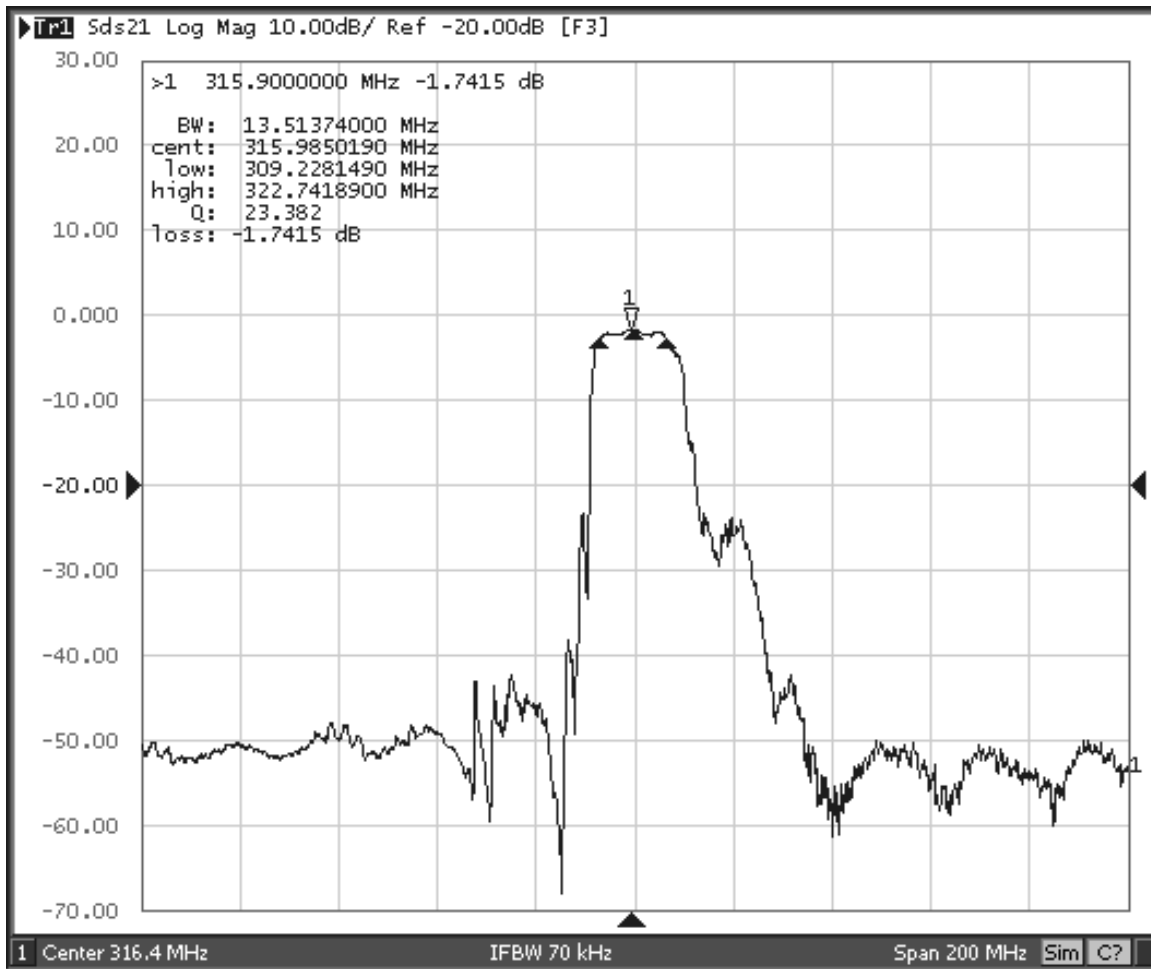

RF3603D Response, 266.4 to 366.4 MHz

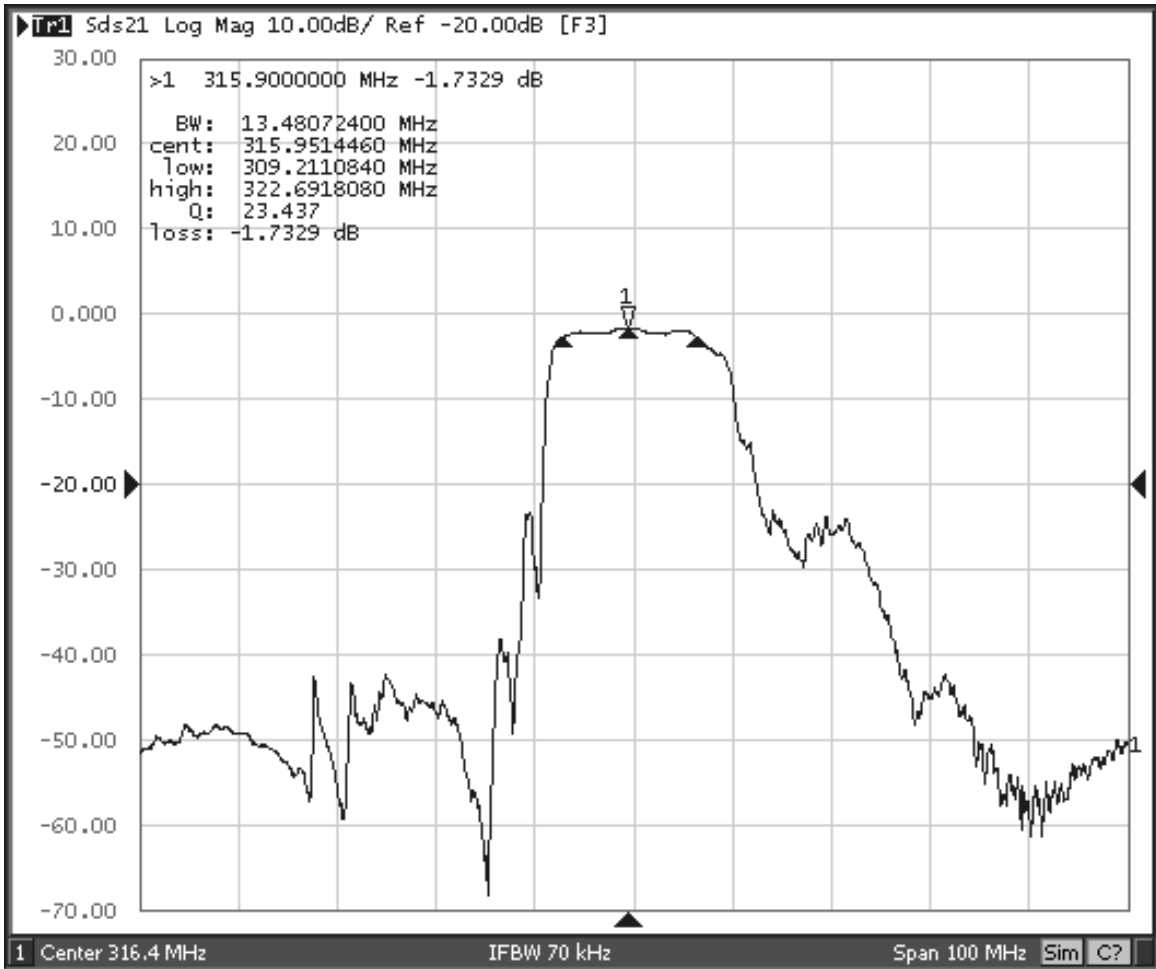

RF3603D Passband Response

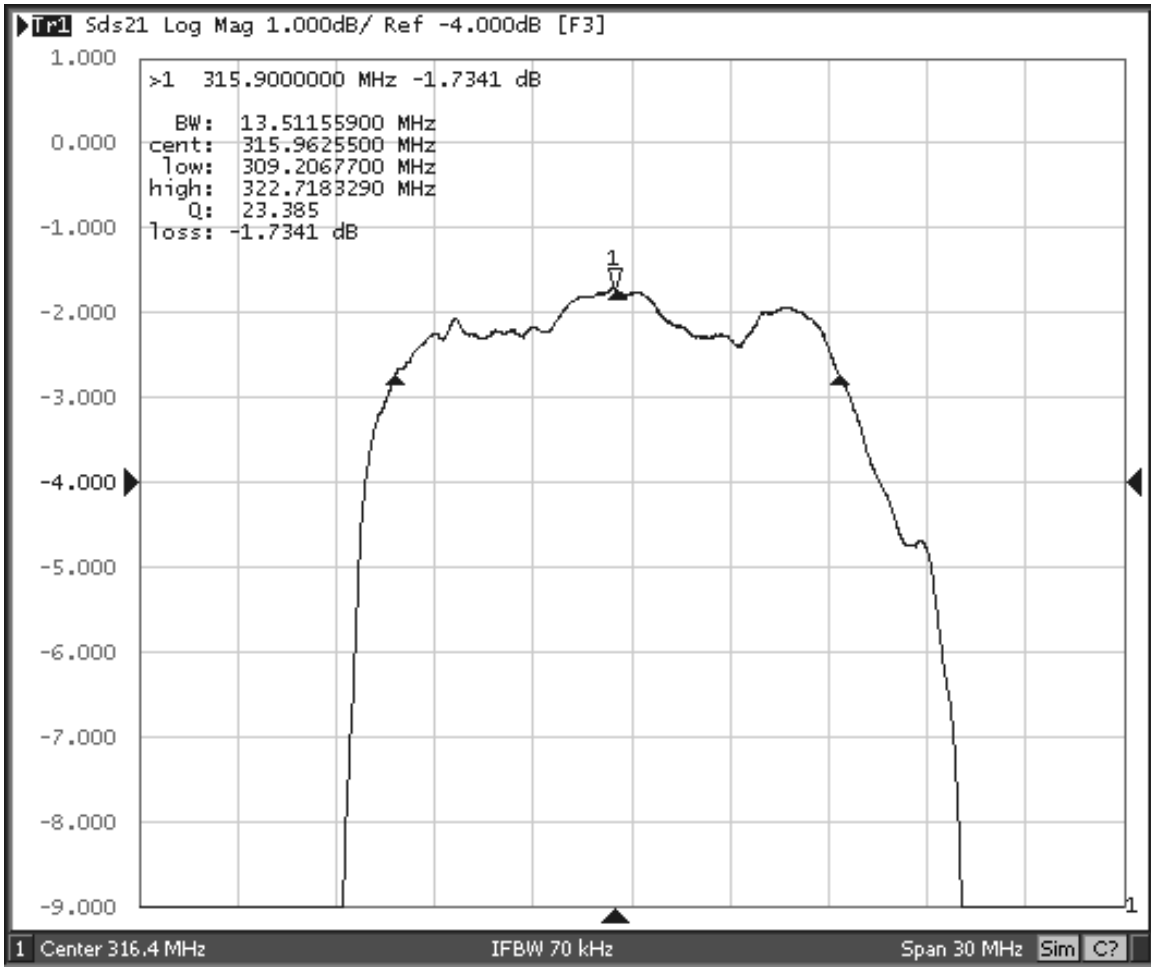

RF3603D Input Impedance Plot

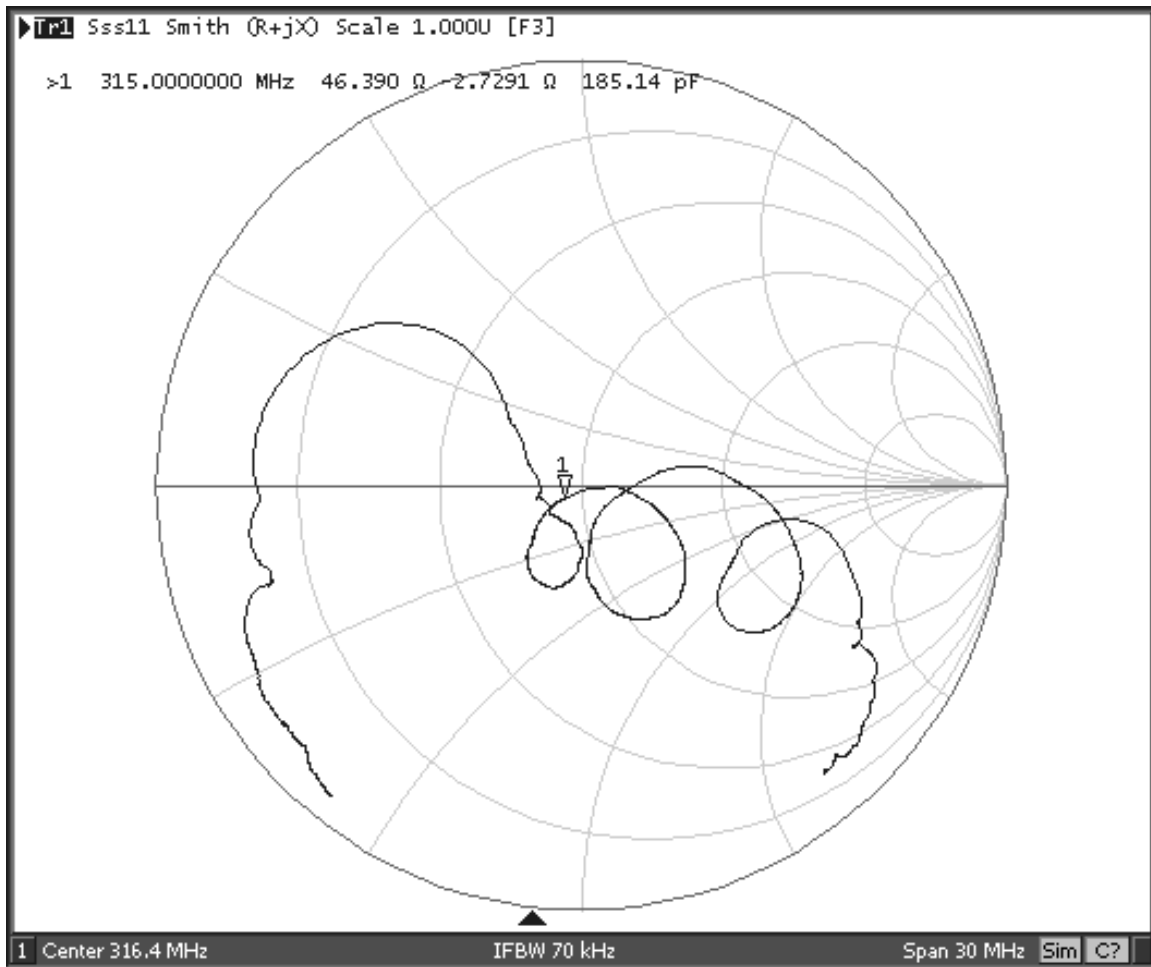

RF3603D Balanced Output Impedance Plot

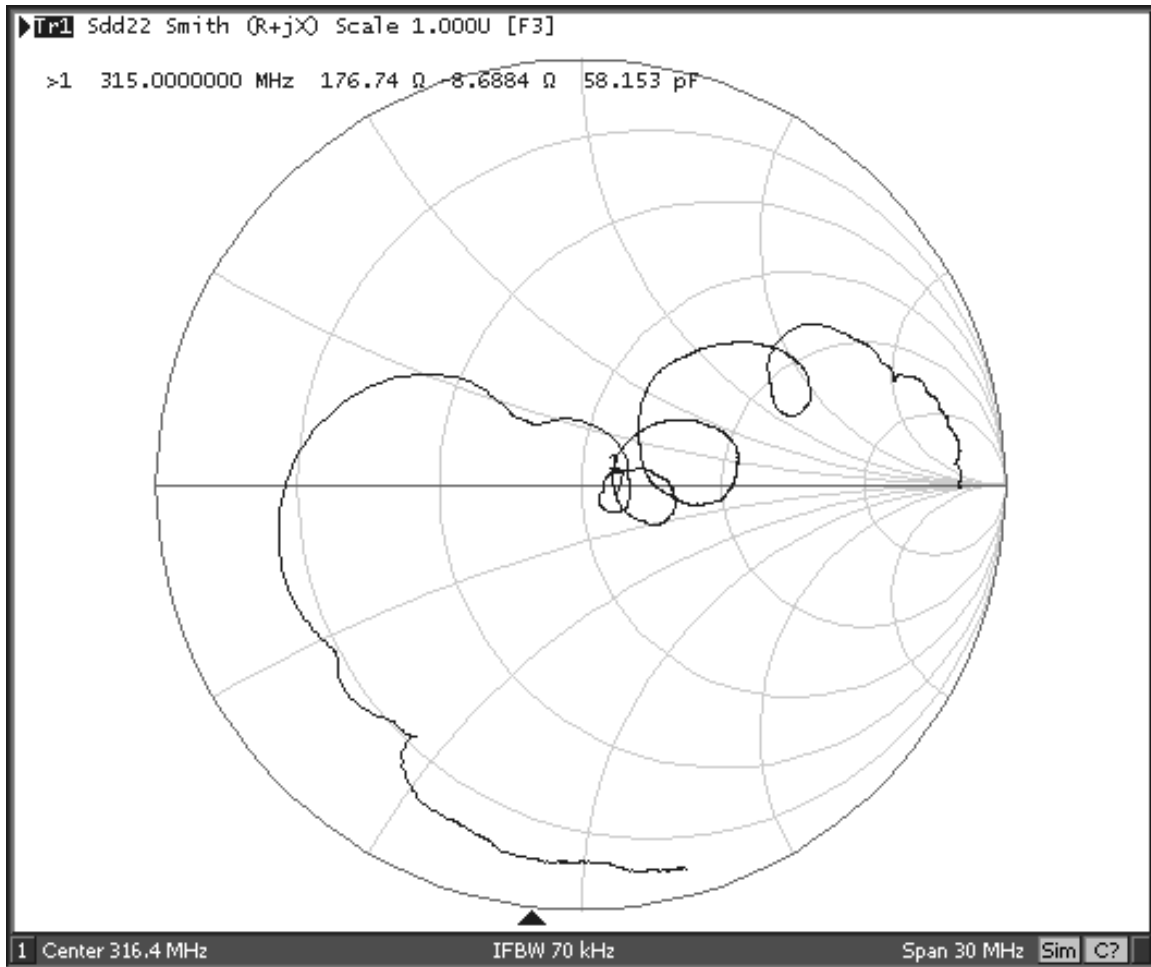

8-Terminal Ceramic Surface-Mount Case 3.8 X 3.8 mm Nominal Footprint

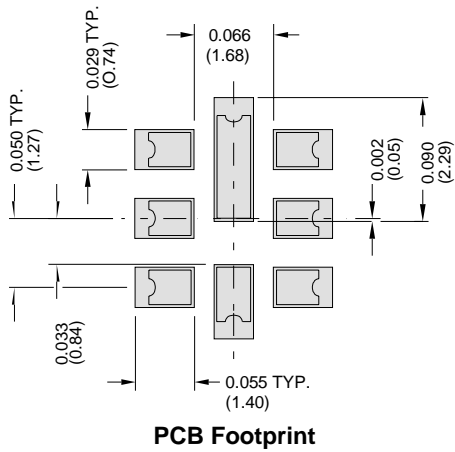

Dimension	Case Dimensions					
	mm			Inches		
	Min	Nom	Max	Min	Nom	Max
A	3.6	3.8	4.0	0.142	0.150	0.157
B	3.6	3.8	4.0	0.142	0.150	0.157
C	0.90	1.00	1.1	0.035	0.040	0.043
D	0.80	0.90	1.0	0.031	0.035	0.040
E	0.90	1.00	1.10	0.035	0.040	0.043
F	0.50	0.60	0.70	0.020	0.024	0.028
G	2.39	2.54	2.69	0.090	0.100	0.110
H	1.40	1.75	2.05	0.055	0.069	0.080

Materials	
Solder Pad Plating	0.3 to 1.0 μm Gold over 1.27 to 8.89 μm Nickel
Lid Plating	2.0 to 3.0 μm Nickel
Body	Al_2O_3 Ceramic
Pb Free	

