

Preliminary



- 303.325 to 307.300 MHz Filter
- Optimized for use with the TRC105 Transceiver
- Balanced 150 ohm IC Interface
- Complies with Directive 2002/95/EC (RoHS) 

RF3602D

**305.3 MHz
SAW Filter**

Absolute Maximum Ratings

Rating	Value	Units
Input Power Level	+15	dBm
DC Voltage	±5	V
Operating Temperature Range	-40 to +85	°C
Storage Temperature Range in Tape and Reel	-40 to +85	°C

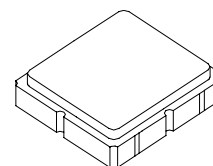

SM3838-8

Electrical Characteristics

Characteristic	Sym	Notes	Min	Typ	Max	Units
Center Frequency	f_C			305.3		MHz
1 dB Bandwidth	BW_1			12.5		MHz
Maximum Insertion Loss, 303.325 to 307.300 MHz	IL_{MAX}			1.8	2.0	dB
Amplitude Ripple, p-p, 303.325 to 307.300 MHz					1.0	
Rejection Referenced to Insertion Loss at 303.825 MHz:						
DC to 285.3 MHz			37	40		
335.3 to 355.3 MHz			27	30		
355.3 to 755.3 MHz			44	47		
755.3 to 1255.3 MHz			50	53		
1255.3 to 2000 MHz			26	29		
Source Impedance	Z_S			50		Ω
Balanced Load Impedance	Z_L			150		Ω

Case Style	SM3838-8 3.8 x 3.8 mm Nominal Footprint					
Lid Symbolization (Y=year, WW=week, S=shift) dot=pin 1 indicator	885, YWWS					
Standard Reel Quantity	Reel Size 7 Inch					500 Pieces/Reel
	Reel Size 13 Inch					3000 Pieces/Reel

Electrical Connections

Connection	Terminals
Single-ended Port	6
Balanced Port	1, 3
Case Ground	4, 5, 7, 8
No Connection	2



CAUTION: Electrostatic Sensitive Device. Observe precautions for handling.

Notes:

1. Unless noted otherwise, all specifications apply over the operating temperature range with filter soldered to the specified demonstration board with impedance matching to 50 Ω and measured with 50 Ω network analyzer.
2. Unless noted otherwise, all frequency specifications are referenced to the nominal center frequency, f_C .
3. Rejection is measured as attenuation below the minimum IL point in the passband. Rejection in final user application is dependent on PCB layout and external impedance matching design. See Application Note No. 42 for details.
4. The design, manufacturing process, and specifications of this filter are subject to change.
5. US and international patents may apply.
6. RFM, stylized RFM logo, and RF Monolithics, Inc. are registered trademarks of RF Monolithics, Inc.

RF3602D-TRC105 Application Circuit

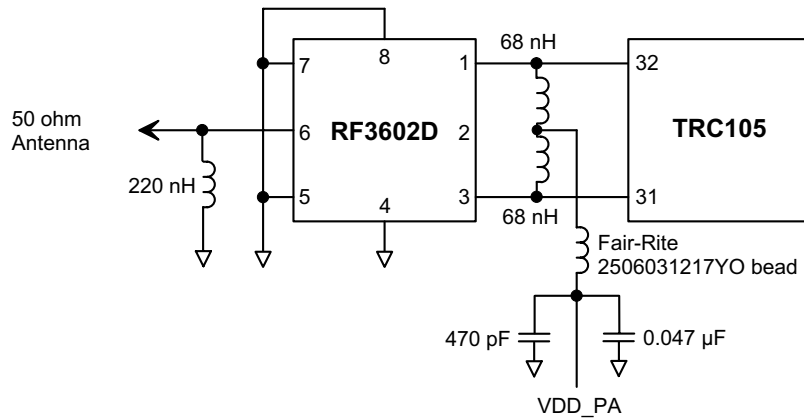

RF3602D 50 Ohm Tuning Network

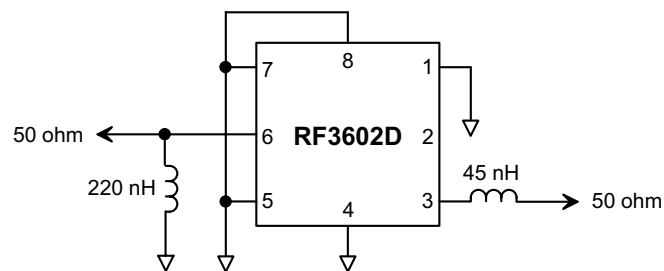

RF3602D Broadband Response, 200 to 2000 MHz

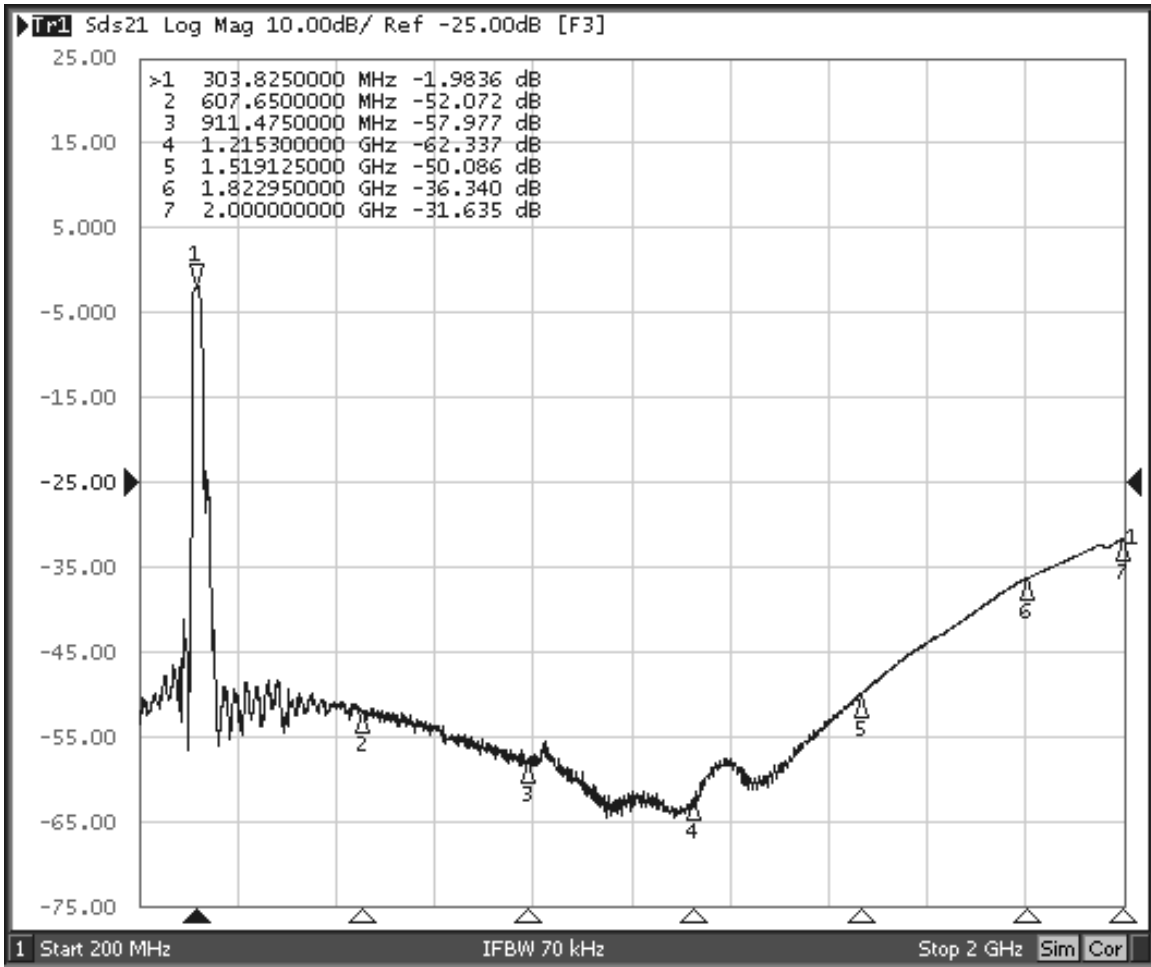

RF3602D Response, 205 to 405 MHz

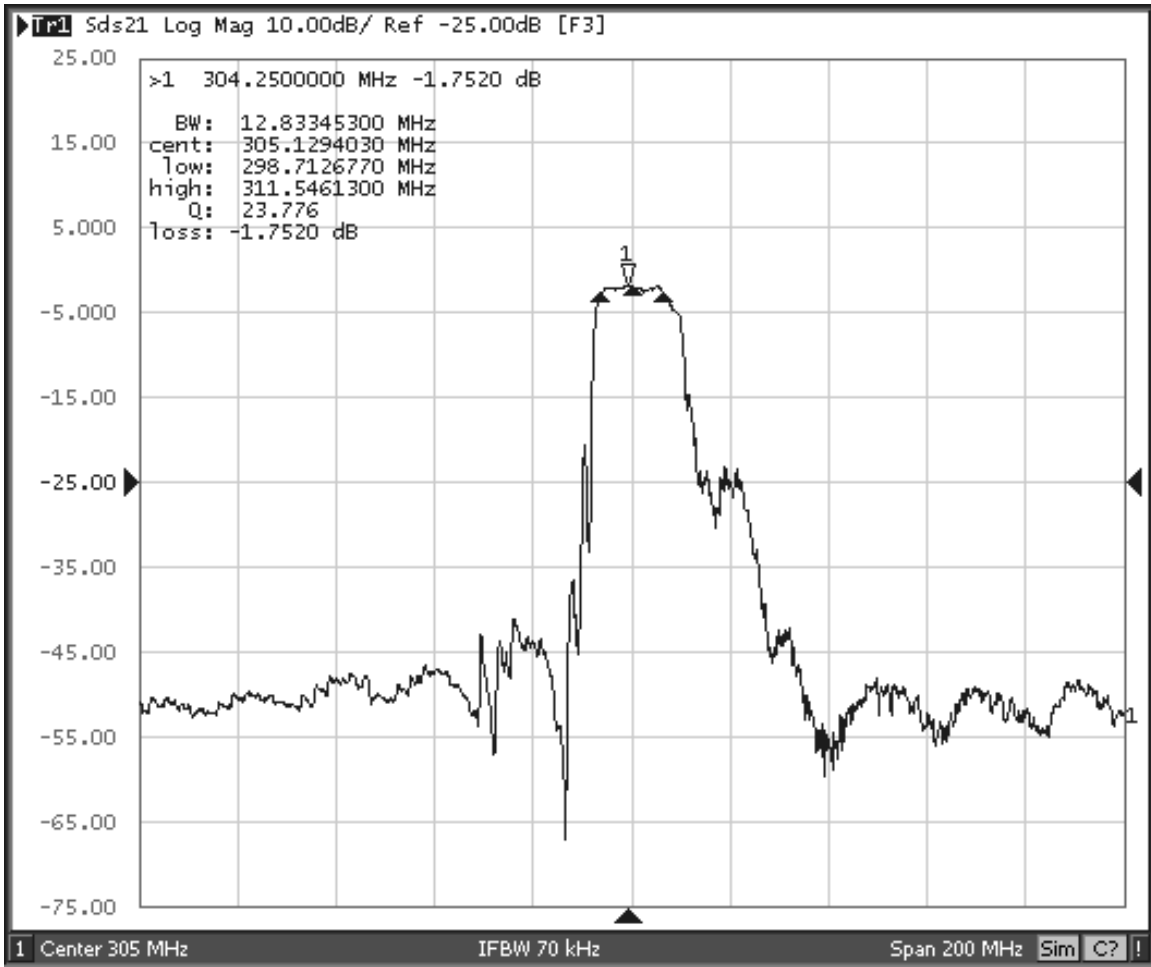

RF3602D Response, 255 to 355 MHz

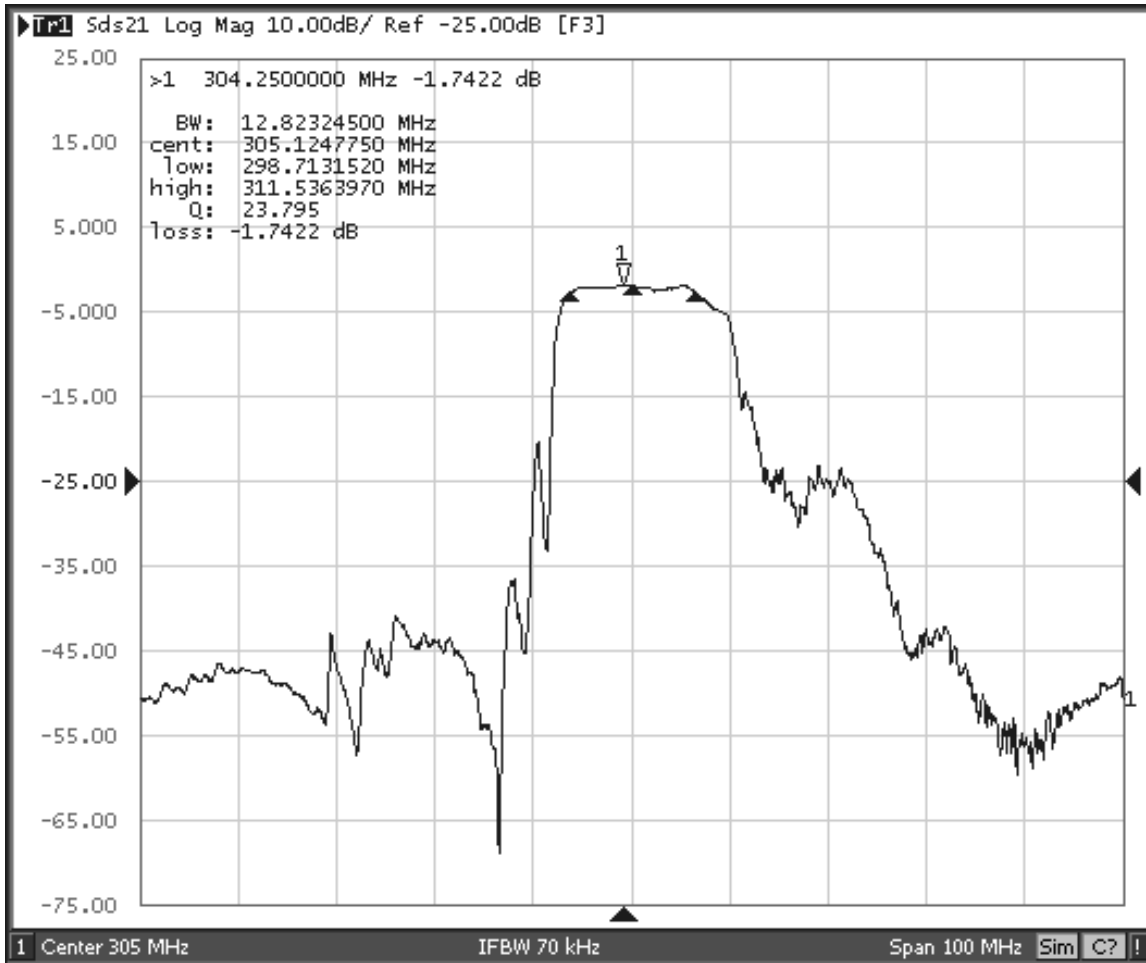

RF3602D Passband Response

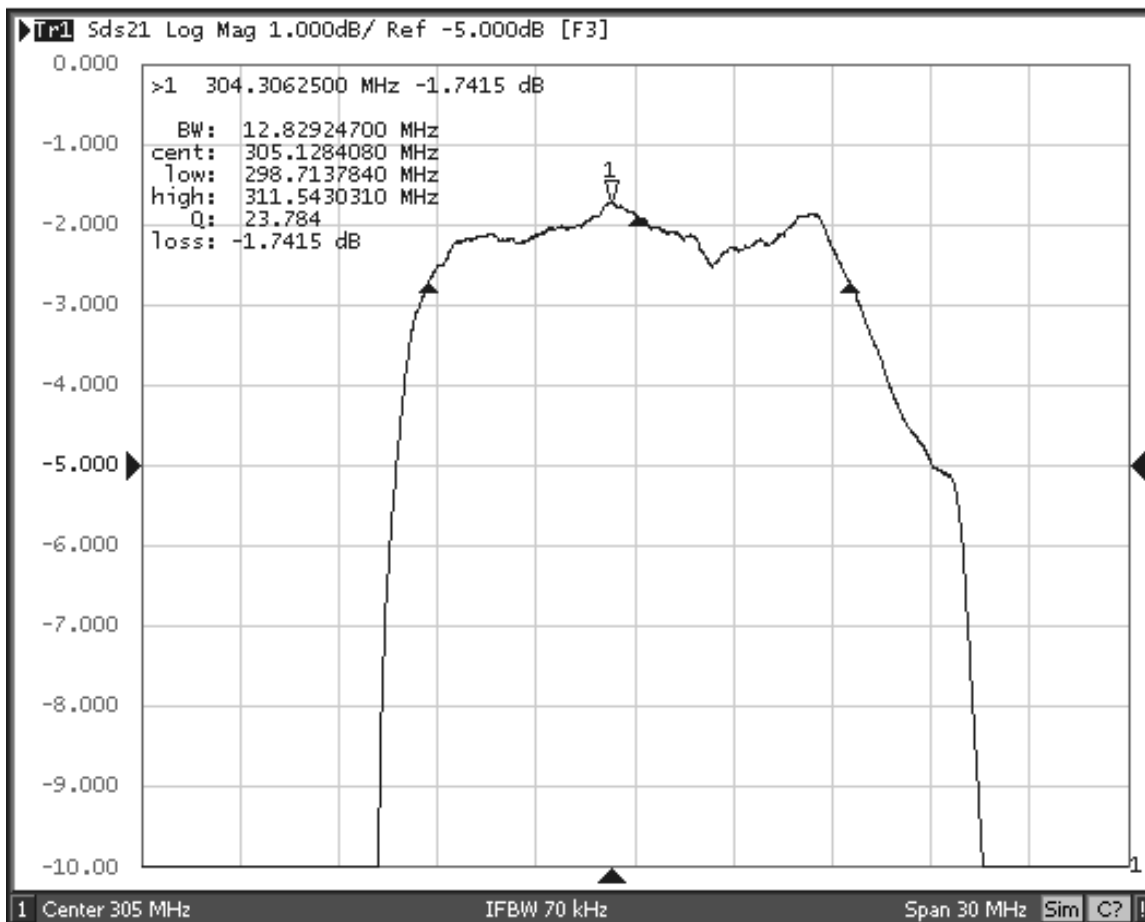

RF3602D Input Impedance Plot

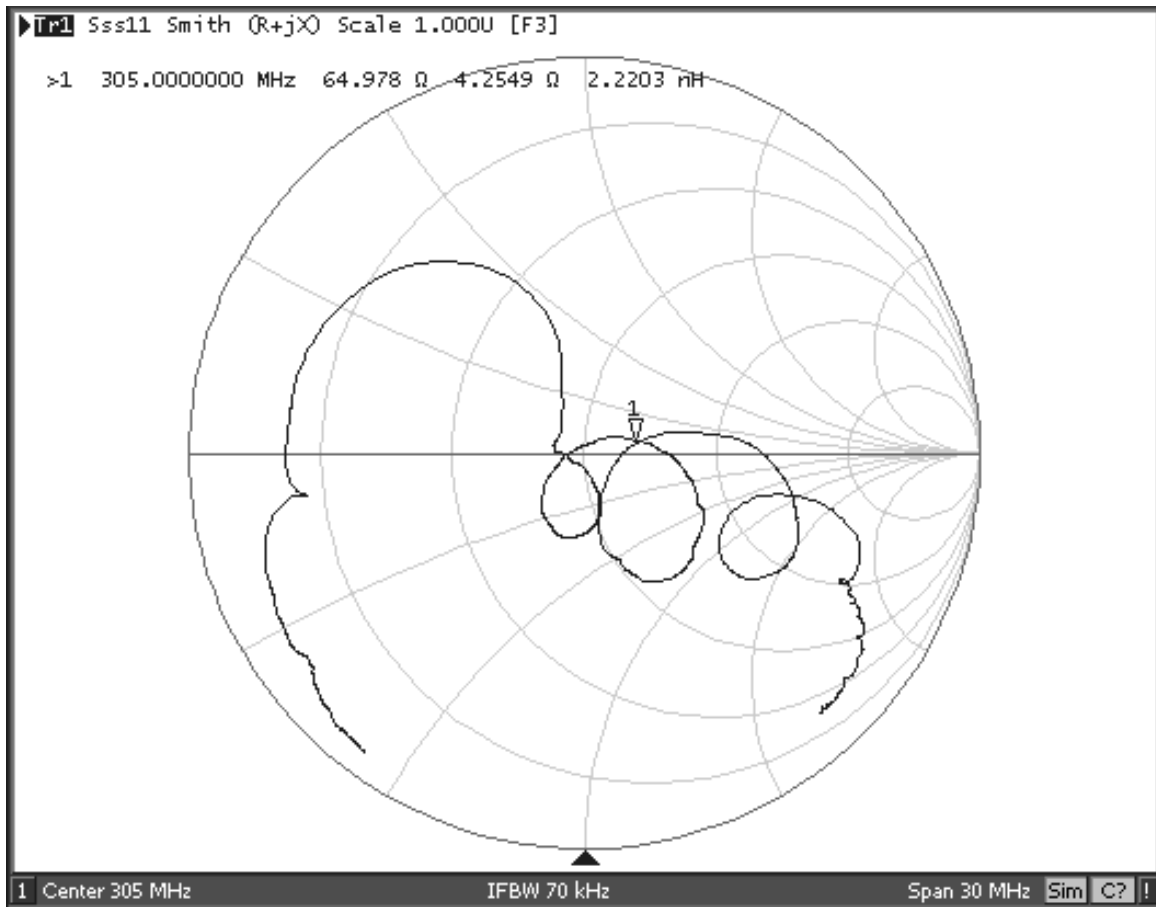

RF3602D Balanced Output Impedance Plot

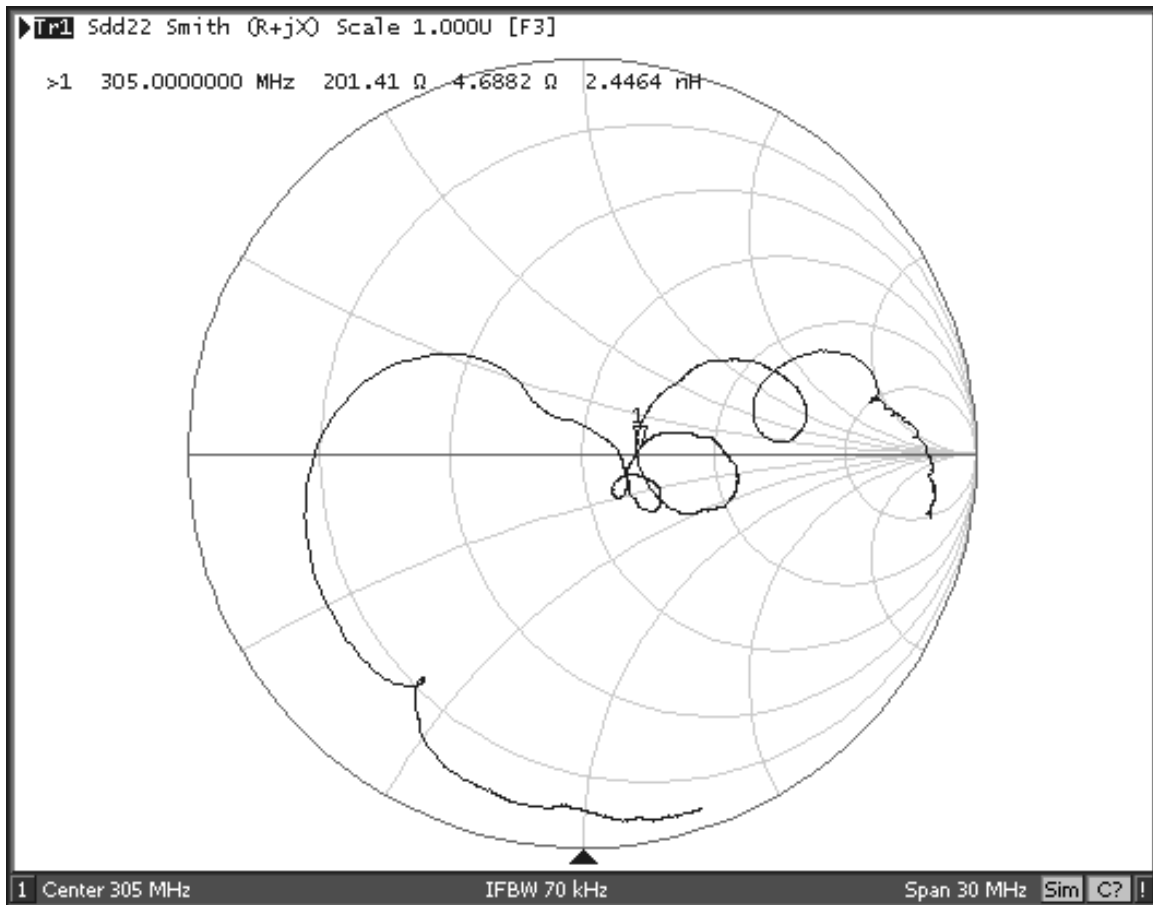

8-Terminal Ceramic Surface-Mount Case 3.8 X 3.8 mm Nominal Footprint

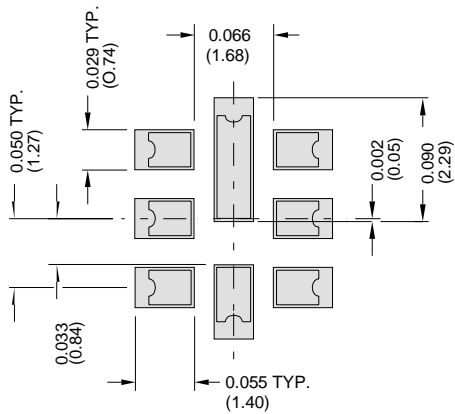

PCB Footprint

Case Dimensions						
Dimension	mm			Inches		
	Min	Nom	Max	Min	Nom	Max
A	3.6	3.8	4.0	0.142	0.150	0.157
B	3.6	3.8	4.0	0.142	0.150	0.157
C	0.90	1.00	1.1	0.035	0.040	0.043
D	0.80	0.90	1.0	0.031	0.035	0.040
E	0.90	1.00	1.10	0.035	0.040	0.043
F	0.50	0.60	0.70	0.020	0.024	0.028
G	2.39	2.54	2.69	0.090	0.100	0.110
H	1.40	1.75	2.05	0.055	0.069	0.080

Materials	
Solder Pad Plating	0.3 to 1.0 μm Gold over 1.27 to 8.89 μm Nickel
Lid Plating	2.0 to 3.0 μm Nickel
Body	Al_2O_3 Ceramic
Pb Free	

TOP VIEW

BOTTOM VIEW

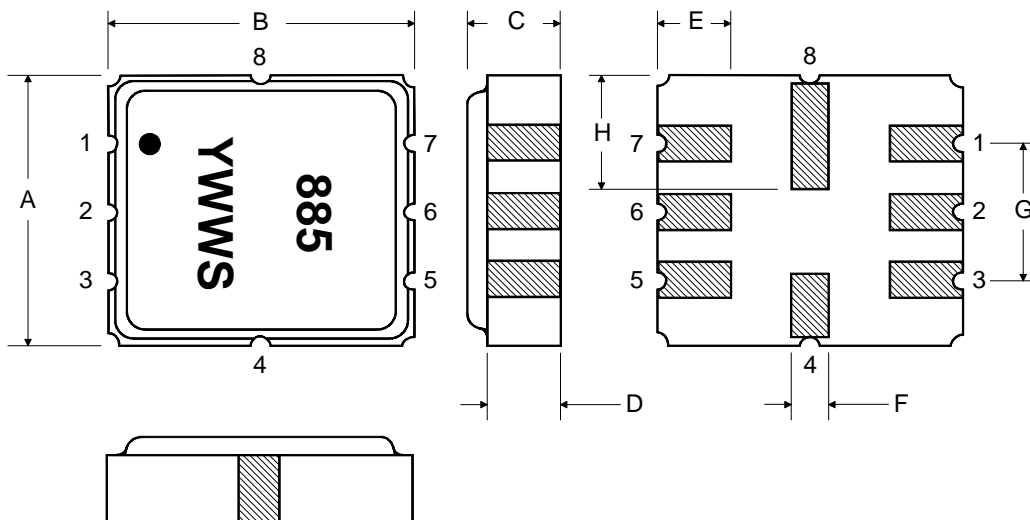

Tape and Reel Specifications

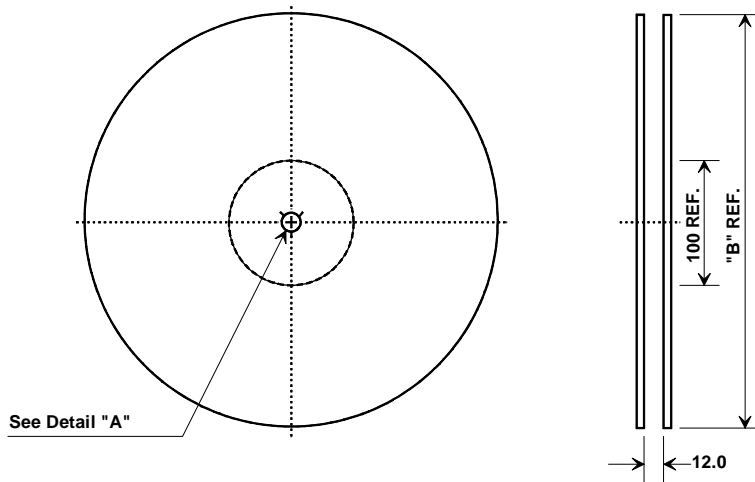

"B" Nominal Size		Quantity Per Reel
Inches	millimeters	
7	178	500
13	330	3000

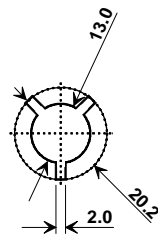

COMPONENT ORIENTATION and DIMENSIONS

Carrier Tape Dimensions	
Ao	4.25 mm
Bo	4.25 mm
Ko	1.30 mm
Pitch	8.0 mm
W	12.0 mm

