



**BOURNS®**

### Features

- Push switch option standard
- Compact, rugged design
- High reliability
- Metal bushing/shaft
- Surface mount version



## PEC11S Series - 12 mm SMD Incremental Encoder

### Electrical Characteristics

Output .....	2-bit quadrature code
Closed Circuit Resistance .....	3 ohms maximum
Contact Rating .....	10 mA @ 5 VDC
Insulation Resistance .....	100 megohms @ 250 VDC
Dielectric Withstanding Voltage	
Sea Level .....	300 VAC minimum
Electrical Travel .....	Continuous
Contact Bounce (15 RPM) .....	2.0 ms maximum
RPM (Operating) .....	60 maximum

### Environmental Characteristics

Operating Temperature Range .....	-40 °C to +70 °C (-40 °F to +158 °F)
Storage Temperature Range .....	-40 °C to +85 °C (-40 °F to +185 °F)
Operating Humidity .....	25 % to 85 % R.H.
Rotational Life .....	15,000 cycles minimum
Switch Life .....	20,000 cycles minimum
IP Rating .....	IP 40

### Mechanical Characteristics

Mechanical Angle .....	360 ° continuous
Detent Torque .....	100 ±70 gf.cm (1.36 ±0.1 oz.-in.)
Shaft Push-Pull Strength .....	10 kg max.
Weight .....	5 gm (0.17 oz.) maximum
Terminals .....	Printed circuit board surface mount terminals
Soldering Condition	
Reflow Soldering .....	Sn95.5/Ag2.8/Cu0.7 solder with no-clean flux (see Solder Profiles for recommended time and temperature)
Hand Soldering .....	Not recommended
Hardware .....	No hardware supplied with this encoder

### Switch Characteristics

Switch Type .....	Contact Push ON Momentary SPST
Power Rating (Resistive Load) .....	10 mA at 5 V DC
Switch Travel	
S (Standard) .....	0.5 ± 0.3 mm
H (High) .....	1.5 ± 0.5 mm
Switch Actuation Force .....	See How to Order
Contact Resistance .....	100 mΩ max.

### How To Order

Model	<b>PEC11S - 9 2 20 F - S 0015</b>
Terminal Configuration	9 = Surface Mount Gull-wing Style
Detent Option	2 = 30 Detents
Shaft Length* (see Product Dimensions)	9 = 9.5 mm 13 = 13.5 mm (w/Switch only) 15 = 15.0 mm 20 = 20.0 mm
Shaft Style	F = Flatted, Metal K = Knurled, Metal
Switch Configuration (SPST)	S = 350 ± 100 gf H = 400 ± 200 gf N = No Switch
Resolution	0015 = 15 Pulses per 360 ° Rotation

\*No switch versions - available with 9.5 and 15 mm shaft lengths.  
Switch versions - available with 9.5, 13.5 and 20 mm shaft lengths.

### Quadrature Output Table

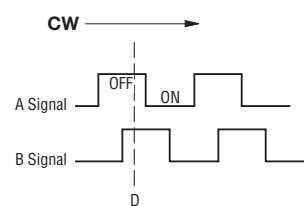

### Switch Circuit

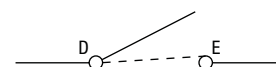

NOTE: D and E are dummy terminals on non-switch version.

\*RoHS Directive 2002/95/EC Jan 27, 2003 including Annex.  
Specifications are subject to change without notice.  
Customers should verify actual device performance in their specific applications.

## Applications

Level control, tuning and timer settings in:

- Audio-visual equipment
- Consumer electric appliances
- Radios
- Musical instrumentation
- Communications equipment

## PEC11S Series - 12 mm SMD Incremental Encoder

**BOURNS®**

### Solder Profile

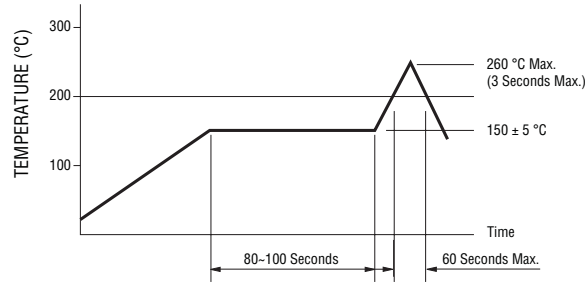

Processing Method: Reflow soldering with infrared heat or forced air convection (only once).

### Product Dimensions

#### Common Dimensions

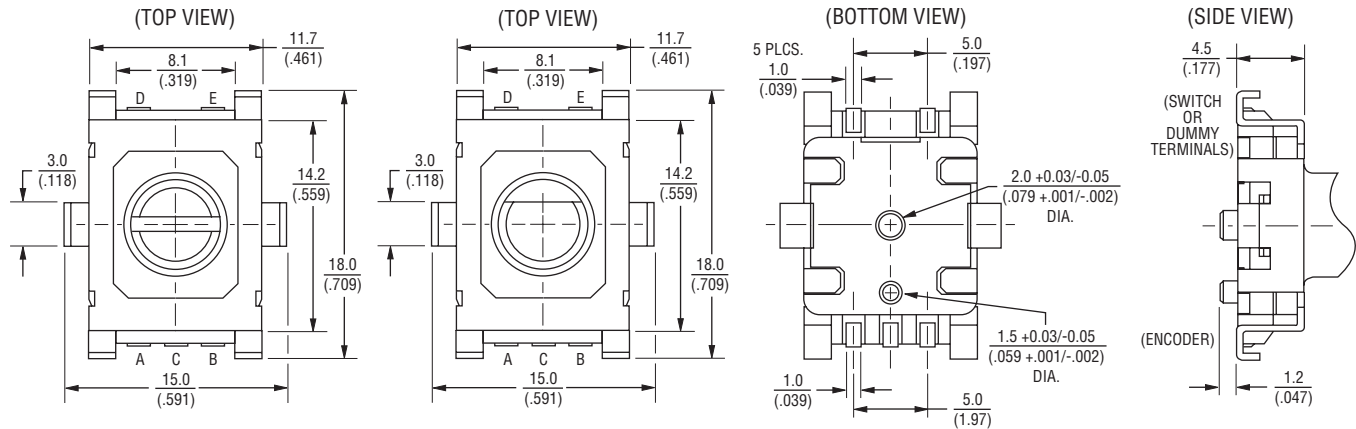

TOLERANCES (UNLESS OTHERWISE NOTED):  $\leq 10 = \pm 0.3$   $\leq (.394) = \pm (.012)$   $> 10 = \pm 0.5$   $> (.394) = \pm (.020)$

### Recommended PCB Layout

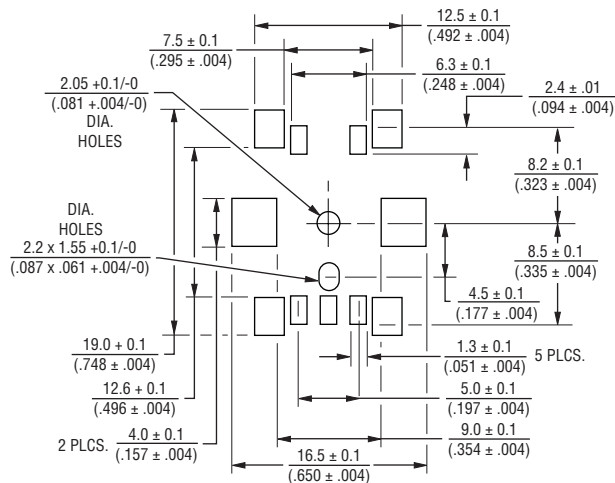

DIMENSIONS:  $\frac{\text{MM}}{\text{(INCHES)}}$

Specifications are subject to change without notice. Customers should verify actual device performance in their specific applications.

# PEC11S Series - 12 mm SMD Incremental Encoder

**BOURNS®**

## Product Dimensions - Shaft Styles

### PEC11S without Switch

KNURLED SHAFT

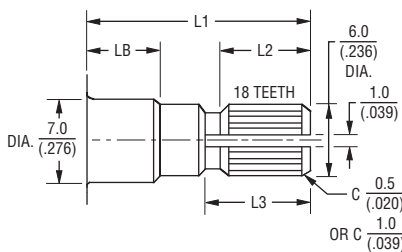

L1	LB	L2	L3
15 (.591)	5 (.197)	8 (.315)	7 (.276)
20 (.787)	7 (.276)	10 (.394)	11 (.433)

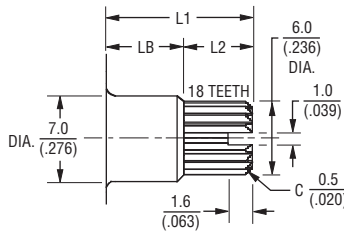

L1	LB	L2
9.5 (.374)	5 (.197)	4.5 (.177)

FLATTED SHAFT

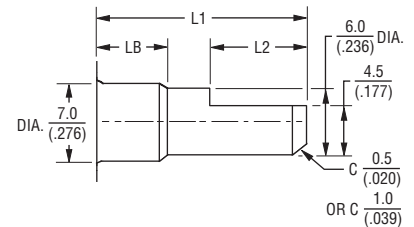

L1	LB	L2
15 (.591)	5 (.197)	7 (.276)
20 (.787)	7 (.276)	12 (.472)

### PEC11S with 0.5 mm Switch Travel

KNURLED SHAFT

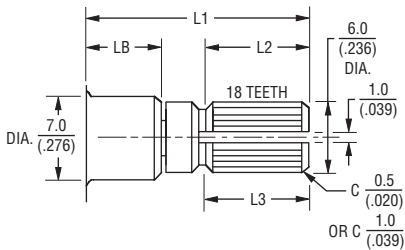

L1	LB	L2	L3
15 (.591)	5 (.197)	7 (.276)	9 (.354)
20 (.787)	7 (.276)	9 (.354)	10 (.394)

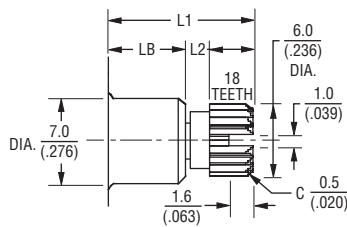

L1	LB	L2
9.5 (.374)	5 (.197)	2.9 (.114)
13.5 (.531)	5 (.197)	6.9 (.272)

FLATTED SHAFT

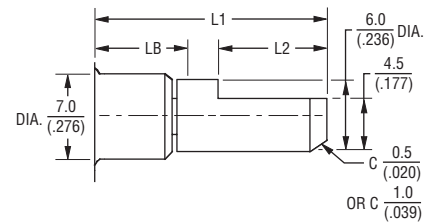

L1	LB	L2
9.5 (.374)	5 (.197)	3 (.118)
15 (.591)	5 (.197)	7 (.276)
20 (.787)	7 (.276)	10 (.394)

### PEC11S with 1.5 mm Switch Travel

KNURLED SHAFT

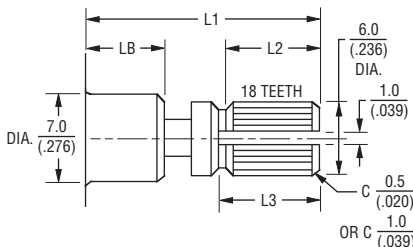

L1	LB	L2	L3
15 (.591)	5 (.197)	6 (.236)	6.5 (.256)
20 (.787)	7 (.276)	8 (.315)	9 (.354)

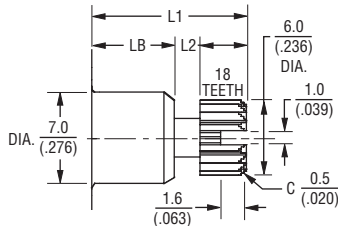

L1	LB	L2
9.5 (.374)	5 (.197)	2.9 (.114)
13.5 (.531)	5 (.197)	6.9 (.272)

FLATTED SHAFT

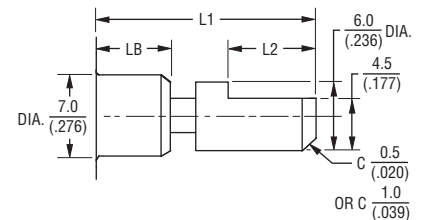

L1	LB	L2
15 (.591)	5 (.197)	7 (.276)
20 (.787)	7 (.276)	10 (.394)
25 (.984)	7 (.276)	12 (.472)

REV. 02/11

Specifications are subject to change without notice.  
Customers should verify actual device performance in their specific applications.

DIMENSIONS:  $\frac{\text{MM}}{\text{(INCHES)}}$