

# Multi Layer Ferrite Chip Beads

## Type CZB

ISO 9001:2000  
CERTIFIED  
TS-16949  
CERTIFIED

### 1. General

- Designed to reduce noise at high frequencies
- Standard EIA Packages: 1E, 1J, 2A, 2B
- Nickel barrier with solder overcoat for excellent solderability
- Magnetically shielded

### 2. Dimensions

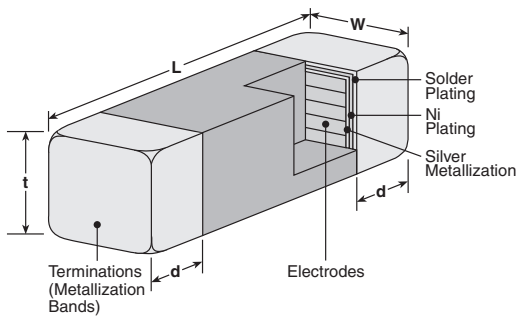
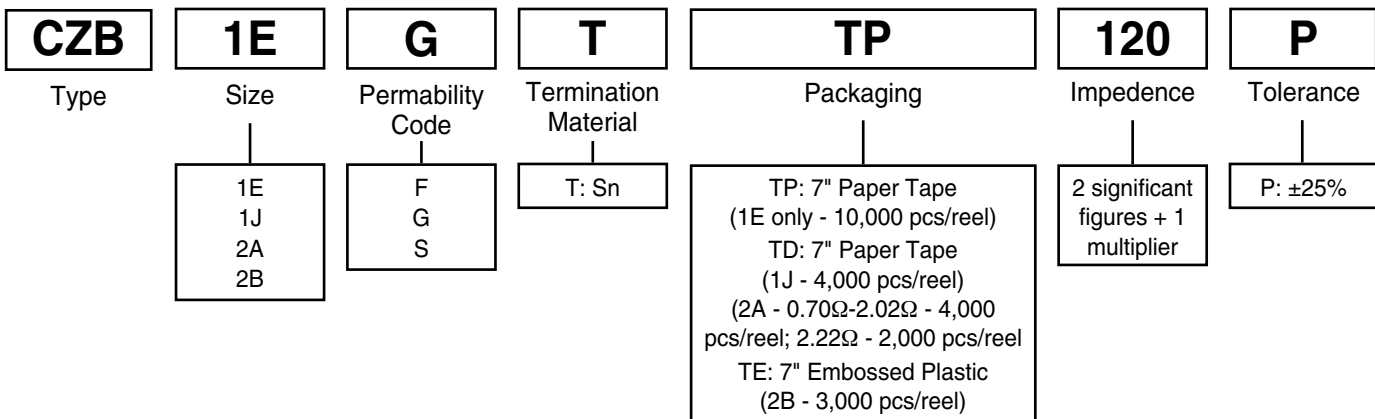

Table 1

Dimensions - inches (mm)				
Part	L	W	t	d
<b>1E</b> <b>(0402)</b>	0.039±0.004 (1.00±0.10)	0.020±0.004 (0.50±0.10)	0.020±0.004 (0.50±0.10)	0.010±0.004 (0.25±0.10)
<b>1J</b> <b>(0603)</b>	0.063±0.006 (1.60±0.15)	0.031±0.006 (0.80±0.15)	0.031±0.006 (0.80±0.15)	0.014±0.006 (0.36±0.15)
<b>2A</b> <b>(0805)</b>	0.079±0.008 (2.00±0.20)	0.049±0.008 (1.25±0.20)	0.035±0.008 (0.90±0.20)	0.020±0.010 (0.51±0.25)
<b>2B</b> <b>(1206)</b>	0.126±0.008 (3.20±0.20)	0.063±0.008 (1.60±0.20)	0.043±0.008 (1.10±0.20)	0.020±0.010 (0.51±0.25)

### 3. Type Designation

The type designation shall be in the following form:



## 4. Standard Applications

Part Designation	Impedance @ 100MHz † (Ω)	DC Resistance Maximum †† (Ω)	Allowable DC Current Maximum (mA)	Operating Temperature Range	
CZB1EGTTP100P	10	0.05	500	-55°C to +125°C	
CZB1EGTTP700P	70	0.40	200		
CZB1EGTTP121P	120	0.50			
CZB1EGTTP221P	220	0.70			
CZB1EGTTP301P	300	0.80			
CZB1EGTTP451P	450	0.90	100		
CZB1EGTTP601P	600	1.00	50		
CZB1EGTTP102P	1000	1.50			
CZB1JGTTD300P	30	0.10	400		-55°C to +125°C
CZB1JGTTD400P	40				
CZB1JGTTD600P	60	0.20	300		
CZB1JGTTD800P	80				
CZB1JGTTD900P	90				
CZB1JGTTD101P	100				
CZB1JGTTD121P	120	0.30	250		
CZB1JGTTD141P	140				
CZB1JGTTD151P	150				
CZB1JGTTD181P	180				
CZB1JGTTD221P	220				
CZB1JGTTD301P	300				
CZB1JGTTD421P	420	0.35	250		
CZB1JGTTD451P	450				
CZB1JGTTD601P	600	0.40	210		
CZB1JGTTD102P	1000				
CZB1JGTTD152P	1500	0.45	250		
CZB1JGTTD202P	2000				
CZB1JGTTD180P	180	0.60	210		
CZB1JGTTD300P	300				
CZB1JGTTD421P	420	0.70	200		
CZB1JGTTD601P	600				
CZB1JGTTD102P	1000	0.80	100		
CZB1JSTTD180P	180				
CZB1JSTTD300P	300	0.80	50		
CZB1JSTTD421P	420				
CZB1JSTTD601P	600	0.10	400		
CZB1JSTTD102P	1000				
CZB2AFTTD070P	7	0.10	800	-55°C to +125°C	
CZB2AFTTD110P	11				
CZB2AFTTD170P	17				
CZB2AFTTD300P	30				
CZB2AFTTD400P	40				
CZB2AFTTD500P	50				
CZB2AFTTD600P	60				
CZB2AFTTD800P	80				
CZB2AGTTD101P	100	0.15	600		

† Impedance test method: HP4291A

†† DCR test method: Keithley 580

## 4. Standard Applications (continued)

Part Designation	Impedance @ 100MHz † (Ω)	DC Resistance Maximum †† (Ω)	Allowable DC Current Maximum (mA)	Operating Temperature Range
CZB2AGTTD121P	120	0.15	600	-55°C to +125°C
CZB2AGTTD151P	150	0.25	400	
CZB2AGTTD201P	200	0.30	200	
CZB2AGTTD221P	220			
CZB2AGTTD301P	300		300	
CZB2AGTTD601P	600			
CZB2AGTTD601PV	600	0.25	500	
CZB2AGTTD102P	1000	0.40	200	
CZB2AGTTD152P	1500	0.55		
CZB2AGTTD202P	2000	0.60		
CZB2AGTTD222P	2200	0.80		
CZB2ASTTD300P	30	0.20	500	
CZB2ASTTD600P	60			
CZB2ASTTD121P	120	0.25	300	
CZB2ASTTD201P	200	0.35		
CZB2ASTTD221P	220	0.25	200	
CZB2ASTTD301P	300	0.35	300	
CZB2ASTTD601P	600	0.40	200	
CZB2ASTTD102P	1000	0.60		
CZB2BFTTE190P	19	0.10	800	
CZB2BFTTE260P	26			
CZB2BFTTE300P	30			
CZB2BFTTE310P	31			
CZB2BFTTE500P	50			
CZB2BFTTE600P	60			
CZB2BFTTE700P	70			
CZB2BFTTE800P	80			
CZB2BFTTE900P	90			
CZB2BFTTE101P	100			
CZB2BFTTE121P	120	0.20	500	
CZB2BFTTE151P	150			
CZB2BFTTE201P	200			
CZB2BFTTE301P	300			
CZB2BFTTE601P	600			
CZB2BGTTTE102P	1000	0.60	200	
CZB2BGTTTE152P	1500 @ 50MHz	0.70		
CZB2BGTTTE202P	2000 @ 30MHz			
CZB2BGTTTE222P	2200 @ 50MHz	1.00		
CZB2BSTTE190P	19	0.10	600	
CZB2BSTTE121P	120	0.25	300	
CZB2BSTTE301P	300	0.30	250	
CZB2BSTTE601P	600			
CZB2BSTTE102P	1000		0.55	200

† Impedance test method: HP4291A

†† DCR test method: Keithley 580

**5. 0402 Graphs**

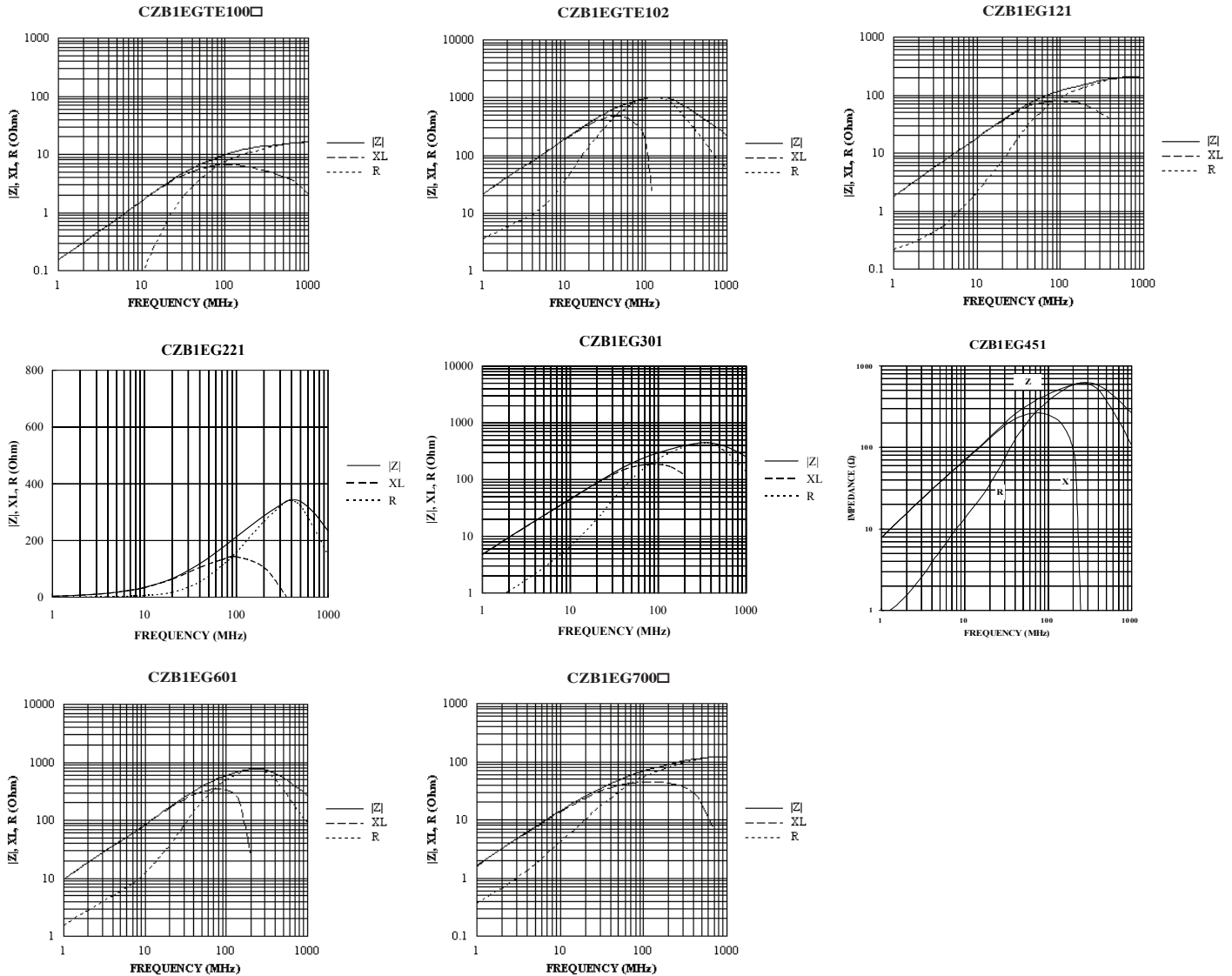

**5. 0603 Graphs**

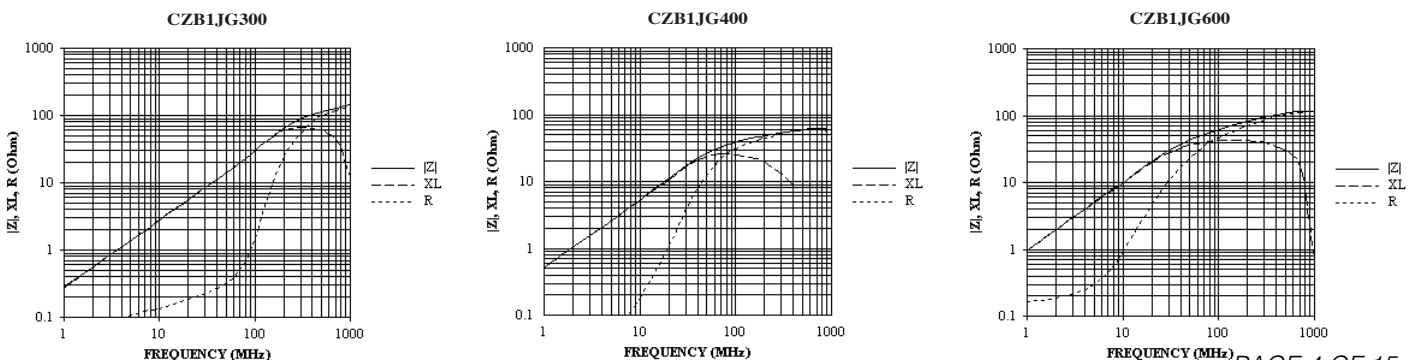

**5. 0603 Graphs (continued)**

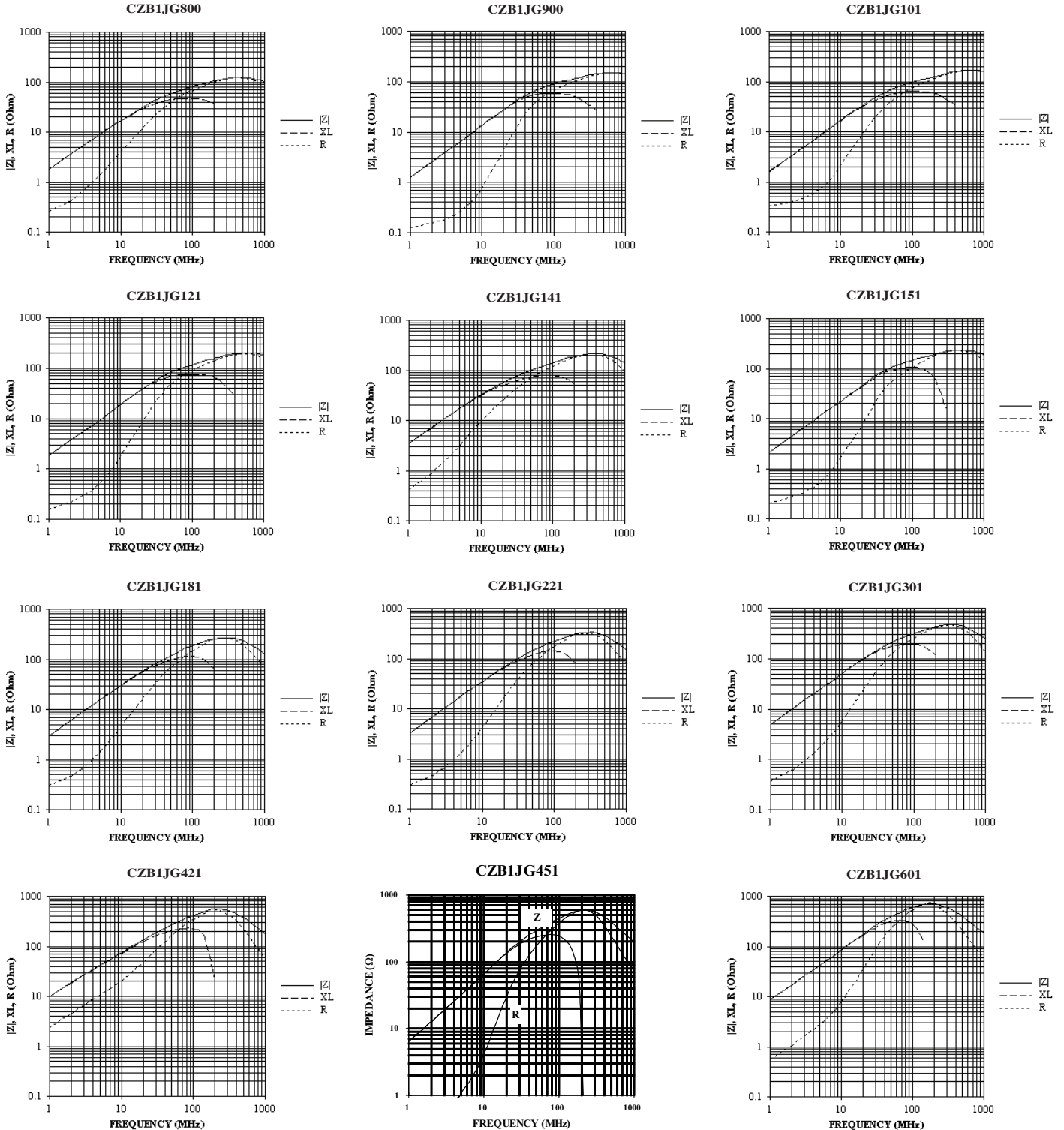

**5. 0603 Graphs (continued)**

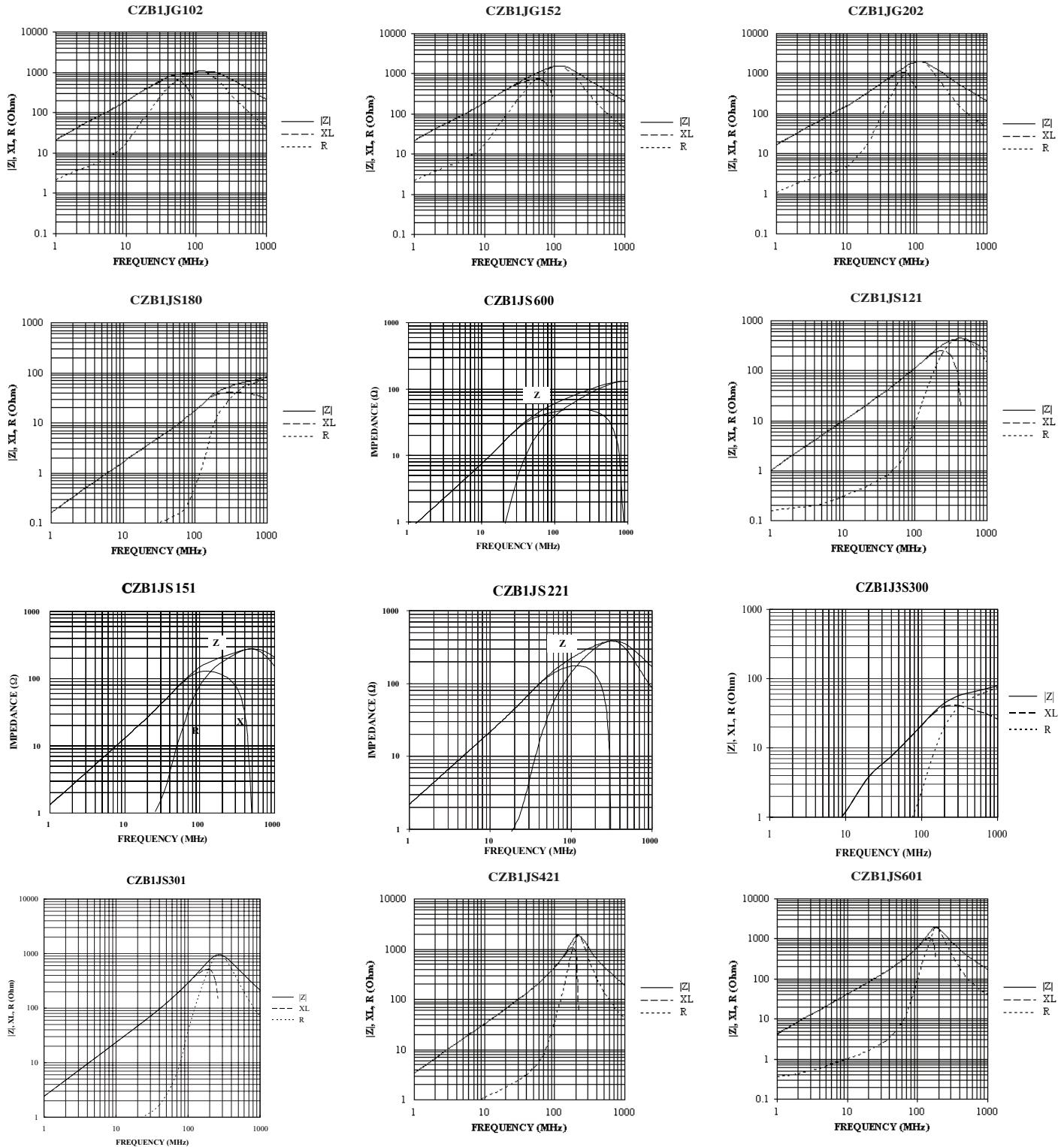

**5. 0603 Graphs (continued)**

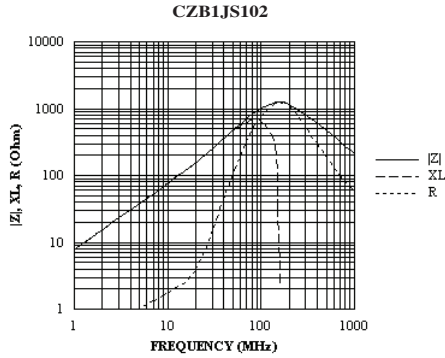

**5. 0805 Graphs**

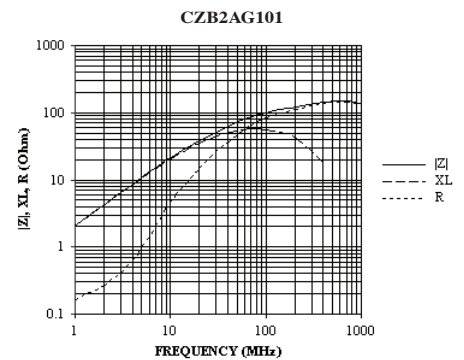
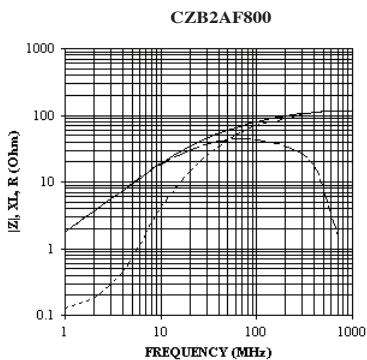
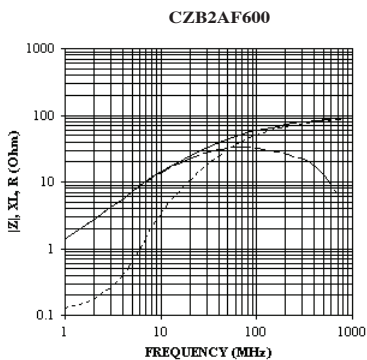
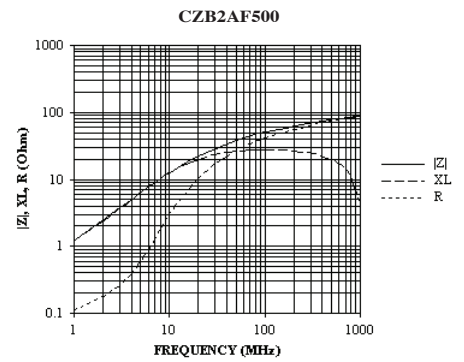
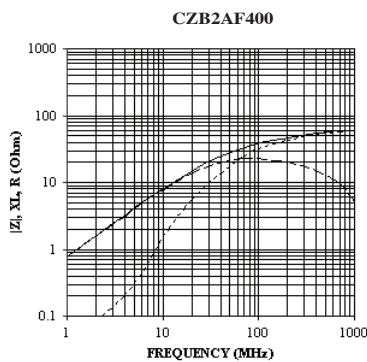
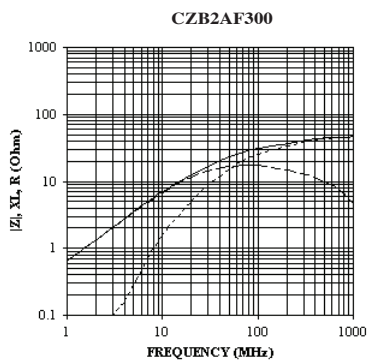
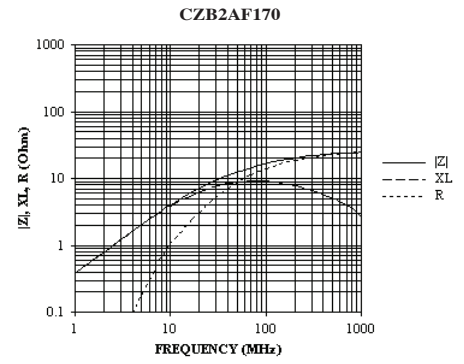
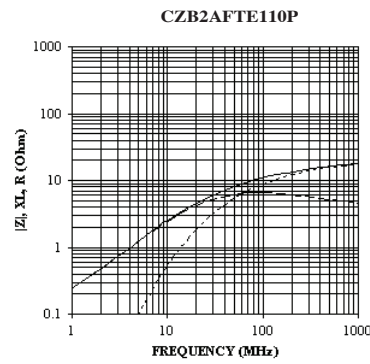
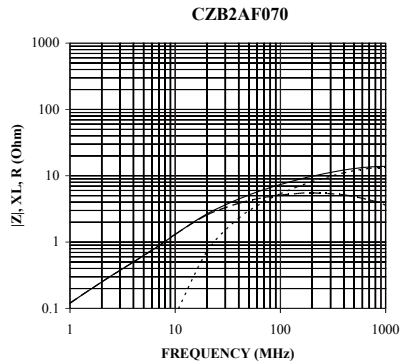

**5. 0805 Graphs**

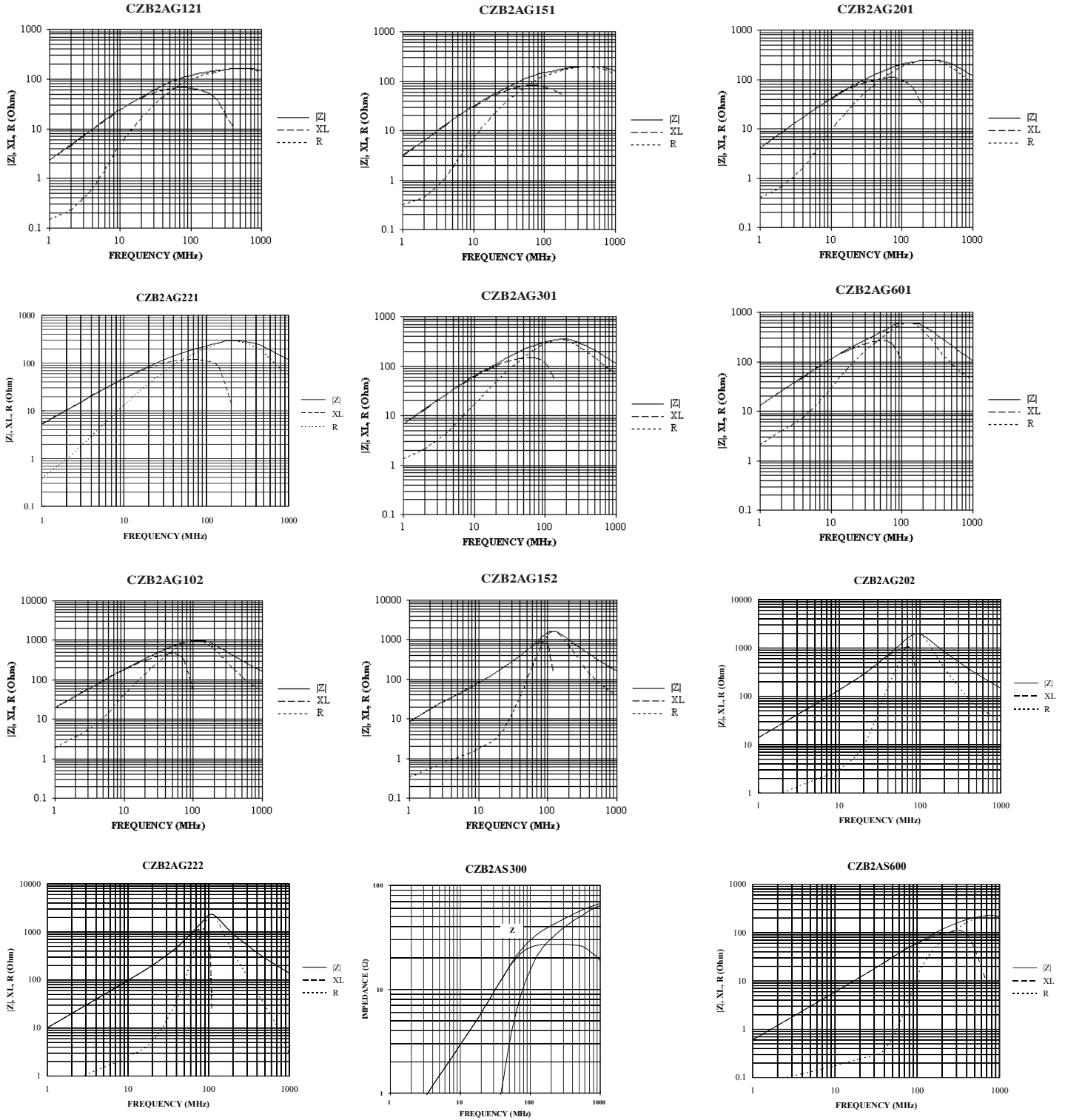



## 5. 0805 Graphs (continued)

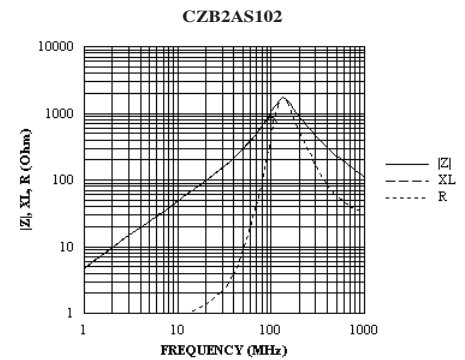
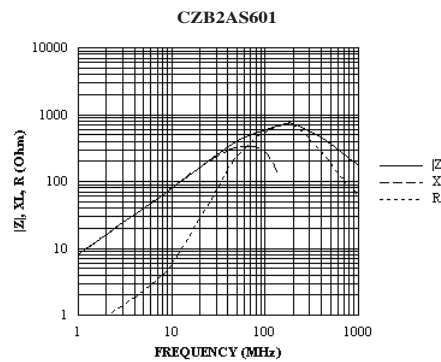
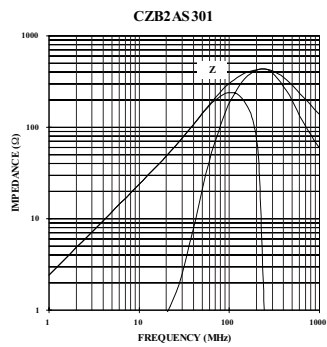
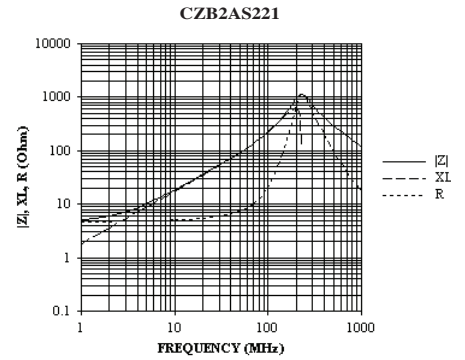
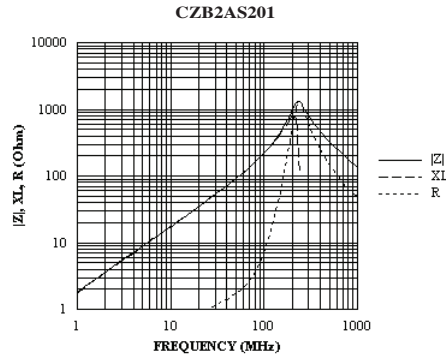
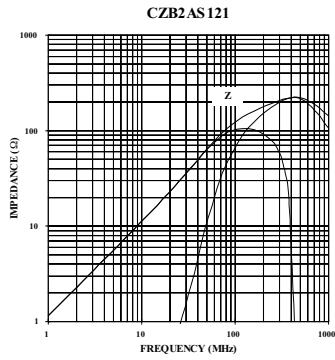

**5. 1206 Graphs**

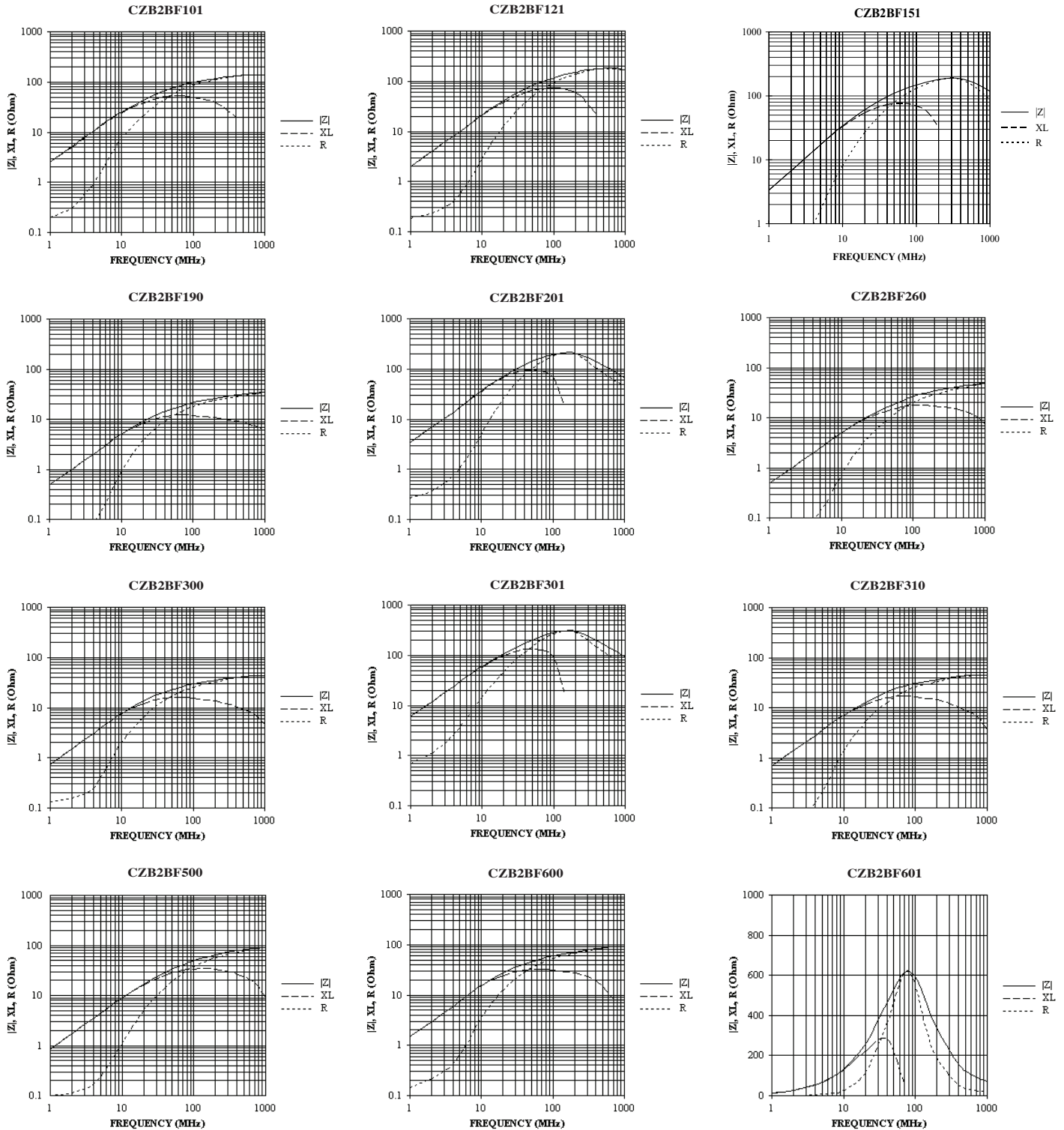

5. 1206 Graphs (continued)

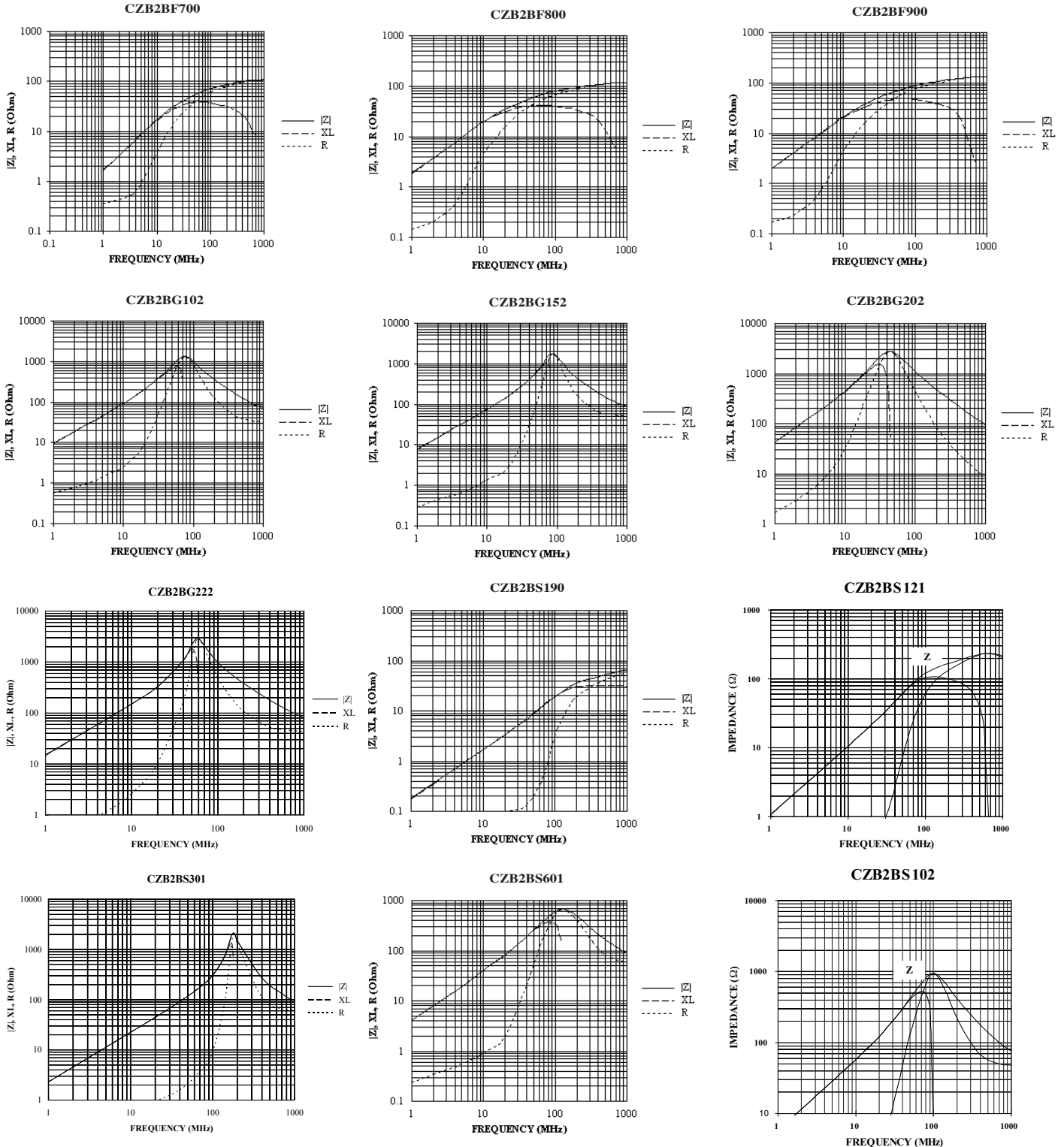

## 5. Characteristics

Item	Requirement	Conditions															
Operating Temperature	-55°C ~ +125°C																
Storage Temperature	40°C @ 70% Humidity	Sealed plastic bags with desiccant shall be used to reduce the potential of oxidation on the terminations during storage.															
Resistance to Solder Heat	<b>Change in Impedance:</b> Relative to value before test $\pm 20\%$ . <b>Appearance:</b> There shall be no cracking <b>Solder Coverage:</b> More than 75% of the terminal electrode shall be covered with solder.	<b>Flux:</b> 5-10 sec dip <b>After Flux:</b> Air dry for 15 sec <b>Preheat:</b> 150°C $\pm 10^\circ\text{C}$ <b>Preheat Time:</b> 60 sec <b>Solder Temp:</b> 260°C $\pm 5^\circ\text{C}$ <b>Dip Time:</b> 10 $\pm 1$ sec															
Solderability	<b>Solder Coverage:</b> More than 95% of the termination shall be covered with solder.	<b>Flux:</b> 5-10 sec dip <b>After Flux:</b> Air dry for 15 sec <b>Solder Temp:</b> 245°C $\pm 5^\circ\text{C}$ <b>Dip Time:</b> 5 $\pm 0.5$ sec															
Leach Resistance	<b>Appearance:</b> There shall be no visible signs of physical or mechanical damage (i.e. no cracks) <b>Terminations:</b> Termination must not be leached away for more than 5%.	The bead shall be subjected to the following 5 steps for the period of time shown below. The 5 steps constitute one (1) rotation. 4 rotations shall be carried out. 1) <b>Flux:</b> 5-10 sec 2) <b>After Flux:</b> Air dry for 15 sec 3) <b>Solder Temp:</b> 230°C $\pm 5^\circ\text{C}$ 4) <b>Dip Time:</b> 5 $\pm 0.5$ sec 5) <b>Cool:</b> Air cool for 60 seconds															
Insulation Resistance	<b>Insulation Resistance:</b> Min 1G ohms																
Solvent Resistance	<b>Change in Impedance:</b> Relative to value before test $\pm 10\%$ .	Cleaning by: <b>Washer:</b> Ultrasonic washer (100W) <b>Solvent:</b> Isopropyl alcohol <b>Time:</b> 3 minutes															
Terminal Strength (hanging test)	<b>Appearance:</b> The terminal electrode shall not break off, nor shall there be damage to the body.	<table border="1"> <thead> <tr> <th>Type</th> <th>W(kgf)</th> <th>Time</th> </tr> </thead> <tbody> <tr> <td>1E</td> <td></td> <td>N/A</td> </tr> <tr> <td>1J</td> <td>0.5</td> <td>30 sec <math>\pm 2</math> sec</td> </tr> <tr> <td>2A</td> <td>1.0</td> <td>30 sec <math>\pm 2</math> sec</td> </tr> <tr> <td>2B</td> <td>1.5</td> <td>30 sec <math>\pm 2</math> sec</td> </tr> </tbody> </table>	Type	W(kgf)	Time	1E		N/A	1J	0.5	30 sec $\pm 2$ sec	2A	1.0	30 sec $\pm 2$ sec	2B	1.5	30 sec $\pm 2$ sec
Type	W(kgf)	Time															
1E		N/A															
1J	0.5	30 sec $\pm 2$ sec															
2A	1.0	30 sec $\pm 2$ sec															
2B	1.5	30 sec $\pm 2$ sec															
Terminal Strength (push test)	<b>Appearance:</b> There shall be no evidence of mechanical degradations to terminals or body.	<table border="1"> <thead> <tr> <th>Type</th> <th>W(kgf)</th> <th>Time</th> </tr> </thead> <tbody> <tr> <td>1E</td> <td></td> <td>N/A</td> </tr> <tr> <td>1J</td> <td>1.4</td> <td>60 sec</td> </tr> <tr> <td>2A</td> <td>1.8</td> <td>60 sec</td> </tr> <tr> <td>2B</td> <td>2.3</td> <td>60 sec</td> </tr> </tbody> </table>	Type	W(kgf)	Time	1E		N/A	1J	1.4	60 sec	2A	1.8	60 sec	2B	2.3	60 sec
Type	W(kgf)	Time															
1E		N/A															
1J	1.4	60 sec															
2A	1.8	60 sec															
2B	2.3	60 sec															

## 5. Characteristics (continued)

Item	Requirement	Conditions																		
Bending Strength	<p><b>Appearance:</b> There shall be no physical or mechanical damage</p> <p><b>Impedance:</b> Relative to initial value before test <math>\pm 10\%</math></p>	<p><b>Board:</b> 90x40x1.6mm</p> <p><b>Bend:</b> 1mm</p> <p><b>Time:</b> 5 sec</p>																		
Mechanical Shock	<p><b>Appearance:</b> There shall be no physical or mechanical damage</p> <p><b>Impedance:</b> Relative to initial value before test <math>\pm 10\%</math></p>	<p><b>Force:</b> 50G</p> <p><b>Time:</b> 11 msec</p> <p>There shall be 3 shocks in each of 6 directions (18 shocks total).</p>																		
Vibration	<p><b>Impedance:</b> Relative to initial value <math>\pm 10\%</math></p>	<p>Only endurance conditioning by sweeping shall be made. The entire frequency range from 10-2,000Hz and return to 10Hz in 20 minutes (this shall constitute one cycle). Amplitude: 1.5mm</p> <p>The test shall have a 15G peak and shall be applied for a period of 4 hours (12 cycles) in each of 3 mutually perpendicular directions (a total of 36 cycles within a total of 12 hours).</p>																		
Thermal Shock	<p><b>Appearance:</b> There shall be no physical or mechanical damage.</p> <p><b>Impedance:</b> Relative to initial value <math>\pm 20\%</math>.</p> <p><b>DCR:</b> The DCR shall not exceed initial specified value.</p> <p>Testing of the parts will be made at 0 hours, 250 hours and 500 hours. Before testing the parts shall be allowed to cool to room temperature for 24 hours.</p>	<table border="1"> <thead> <tr> <th>Step</th> <th>Temperature</th> <th>Time</th> </tr> </thead> <tbody> <tr> <td>1-start</td> <td>-40°C <math>\pm 2^\circ\text{C}</math></td> <td>_____</td> </tr> <tr> <td>2-hold</td> <td>-40°C <math>\pm 2^\circ\text{C}</math></td> <td>30 min <math>\pm 5</math> min</td> </tr> <tr> <td>3-transfer</td> <td>_____</td> <td>0.5 min max.</td> </tr> <tr> <td>4-hold</td> <td>+105°C <math>\pm 2^\circ\text{C}</math></td> <td>30 min <math>\pm 5</math> min</td> </tr> <tr> <td>5-transfer</td> <td>_____</td> <td>0.5 min max.</td> </tr> </tbody> </table> <p>Steps 1 thru 5 constitute one complete cycle and the test shall consist of a total of 500 cycles.</p>	Step	Temperature	Time	1-start	-40°C $\pm 2^\circ\text{C}$	_____	2-hold	-40°C $\pm 2^\circ\text{C}$	30 min $\pm 5$ min	3-transfer	_____	0.5 min max.	4-hold	+105°C $\pm 2^\circ\text{C}$	30 min $\pm 5$ min	5-transfer	_____	0.5 min max.
Step	Temperature	Time																		
1-start	-40°C $\pm 2^\circ\text{C}$	_____																		
2-hold	-40°C $\pm 2^\circ\text{C}$	30 min $\pm 5$ min																		
3-transfer	_____	0.5 min max.																		
4-hold	+105°C $\pm 2^\circ\text{C}$	30 min $\pm 5$ min																		
5-transfer	_____	0.5 min max.																		
Load Humidity	<p><b>Appearance:</b> There shall be no physical or mechanical damage</p> <p><b>Impedance:</b> Relative to initial value <math>\pm 15\%</math></p> <p>Measurements shall be taken at 0 hours, 250 hours, 500 hours and 1,000 hours and shall meet the conditions stated above.</p>	<p><b>Temperature:</b> 85°C <math>\pm 2^\circ\text{C}</math></p> <p><b>Relative Humidity:</b> 85%</p> <p><b>Time:</b> 1,000 hours total</p> <p><b>Apply:</b> 100% rated current</p>																		
Life Test	<p><b>Appearance:</b> There shall be no physical or mechanical damage</p> <p><b>Impedance:</b> Relative to initial value <math>\pm 15\%</math></p> <p>Measurements shall be taken at 0 hours, 250 hours, 500 hours and 1,000 hours and shall meet the conditions stated above.</p>	<p><b>Temperature:</b> 85°C <math>\pm 2^\circ\text{C}</math></p> <p><b>Time:</b> 1,000 hours total</p> <p><b>Apply:</b> 100% rated current</p>																		

**6. Dimensions - inches (mm)**

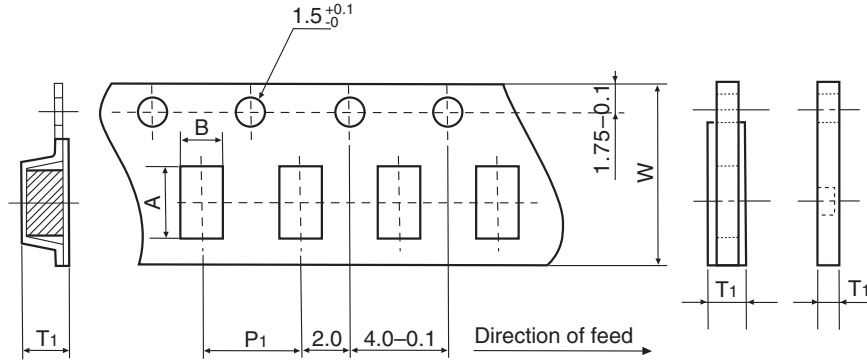

Dimensions - inches (mm)

Tape	A	B	W	P <sub>1</sub>	T <sub>1</sub>
<b>1E 0402</b>	0.046±0.004 (1.17±0.1)	0.026±0.004 (0.65±0.1)	0.315±0.009 (8.0±0.22)	0.079±0.009 (2.0±0.23)	0.025±0.004 (0.63±0.1)
<b>1J 0603</b>	0.075±0.002 (1.9±0.1)	0.043±0.002 (1.1±0.1)	0.318±0.002 (8.1±0.1)	0.157±0.004 (4.0±0.1)	0.043±0.002 (1.1±0.1)
<b>2A 0805</b>	0.093±0.002 (2.4±0.1)	0.063±0.002 (1.6±0.1)	0.318±0.002 (8.1±0.1)	0.157±0.004 (4.0±0.1)	0.046±0.002 (1.2±0.1)
<b>2B 1206</b>	0.138±0.002 (3.5±0.1)	0.071±0.002 (1.8±0.1)	0.318±0.002 (8.1±0.1)	0.157±0.004 (4.0±0.1)	0.071±0.002 (1.8±0.1)

Dimensions - inches (mm)

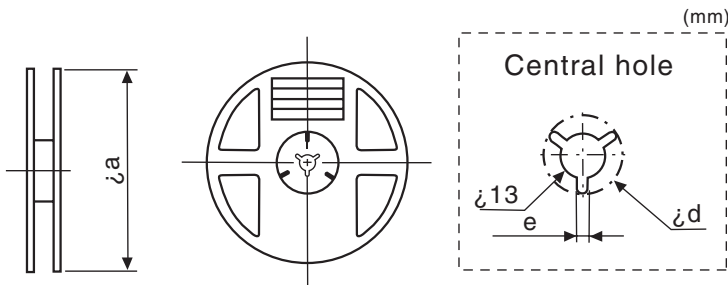

Tape	øa	ød	e
<b>1E 0402</b>	7 (178)	0.827 (21)	0.079 (2.0)
<b>1J 0603</b>			
<b>2A 0805</b>			
<b>2B 1206</b>			

## 7. Recommended PC Board Land Patterns - mm (inches)

Chip Size	L	G	H
<b>1E (0402)</b>	1.6 (0.063)	0.4 (0.016)	0.6 (0.024)
<b>1J (0603)</b>	2.6 (0.102)	0.55 (0.022)	0.94 (0.037)
<b>2A (0805)</b>	3.0 (0.118)	0.66 (0.026)	1.45 (0.057)
<b>2B (1206)</b>	4.4 (0.173)	1.5 (0.059)	1.8 (0.071)

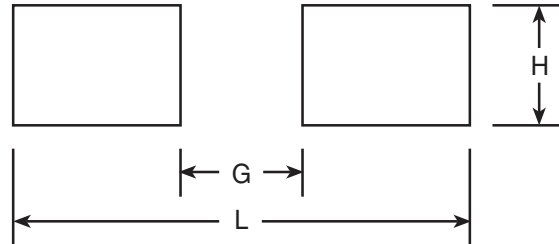

## 8. Recommended Temperature Profiles for Soldering

**Recommended Temperature Profile for Wave Soldering**

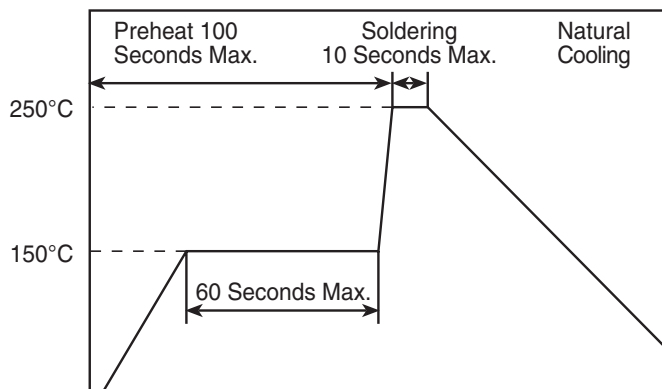

**Recommended Temperature Profile for Reflow Soldering**

