

Product Dimensions

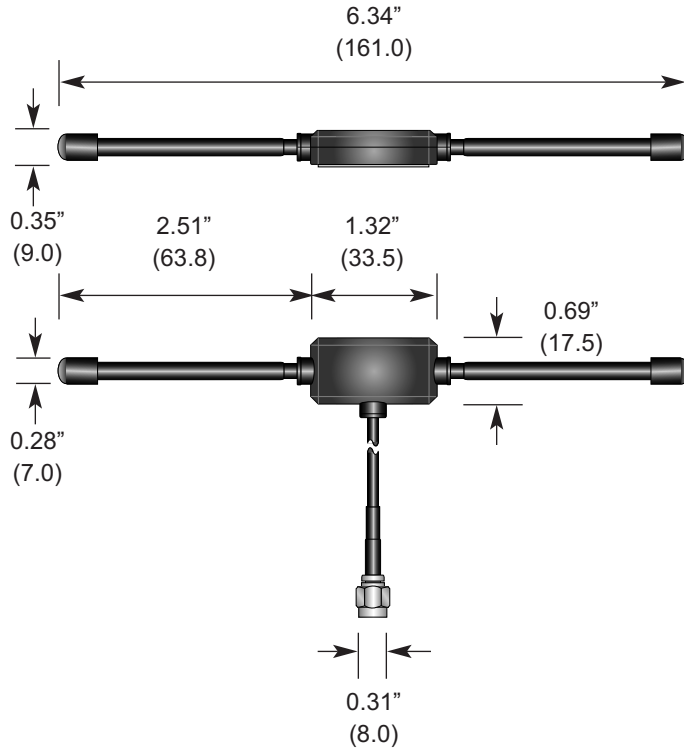

Description



MHW Series dipole antennas feature a durable, unobtrusive housing that sticks permanently with integral adhesive to flat, non-conductive surfaces such as windows, drywall, ceiling tiles, plastic, etc. The antennas are well suited to low-power devices, but are capable of operation at levels to 10 watts. The MHW is supplied with either 6.5 feet (2m) or 15 feet (4.6m) of RG-174 cable and attaches via a standard SMA or Part 15 compliant RP-SMA connector. Custom cable lengths and connectors are available for volume OEM customers.

Features

- Compact & unobtrusive
- Adhesive for flat surfaces
- Excellent performance
- Omni-directional pattern
- Very low VSWR
- Two flexible shafts
- Rugged & damage-resistant
- Standard SMA or Part 15 compliant RP-SMA connector

Electrical Specifications

- | | |
|---------------------------|-------------------------|
| • Center Freq. | 418MHz |
| • Recommended Oper. Freq. | 408-428MHz |
| • Wavelength | 1/2-wave |
| • VSWR | ≤1.5 typ. at center |
| • Impedance | 50 ohms |
| • Connector | RP-SMA or SMA |
| • Cable | 79" or 180" RG-174 coax |

Ordering Information

- ANT-418-MHW-RPS-L (RP-SMA connector, 180" coax)
- ANT-418-MHW-RPS-S (RP-SMA connector, 79" coax)
- ANT-418-MHW-SMA-L (SMA connector, 180" coax)
- ANT-418-MHW-SMA-S (SMA connector, 79" coax)

VSWR Graph

