

Cyaneus GPS Co-planar Antenna

Part No. A10137

Product Specification

1 Features

- GPS antenna designed for embedded applications
- Balanced antenna technology
- High efficiency
- Good resistance to de-tuning
- Intended for SMD mounting
- Supplied in tape on reel
- Low height, small footprint, light weight

2 Description

Cyaneus GPS Co-planar antenna is intended for reception of GPS signals at 1575 MHz.

The antenna uses a ground plane in order to radiate efficiently, which should be at least 20 x 30 mm. It should be noted that the radiation patterns change with the size of the ground plane.

The antenna has RHCP characteristics suitable for reception of GPS signals. The antenna patterns are given in section 7-3 “Antenna Patterns”

3 Applications

- Antenna for mobile phones and handheld devices with embedded GPS systems
- Application specific tracking modules
- Mapping software accessories: USB dongle, SDIO cards, PCMCIA card



Integrated Antenna and RF Solutions

4 Part number

Cyaneus: A10137



5 General data

Product name	Cyaneus
Part Number	A10137
Frequency	GPS - 1575 MHz
Polarization	Linear
Operating temperature	-40 °C to +85 °C
Impedance with matching	50 Ω
Weight	0.7 g
Antenna type	SMD
Dimensions	9 x 20.1 x 1.6 [mm]

6 Electrical characteristics

	Typical performance Reference Board A10137-R	Typical performance Reference Board A10137-D	Conditions
Bandwidth	>20 MHz at -10 dB Return Loss	>30 MHz at -10 dB Return Loss	All data measured on Antenna's reference boards, part numbers A10137-R and A10137-D Data given for the 1573.42 – 1577.42 MHz frequency range
Peak gain (Linear)	0.9 dBi	0.9 dBi	
Average gain (Linear)	-2.2 dBi	-1.6 dBi	
Average efficiency (Linear)	61%	69%	
Peak gain (RHCP)	0.1 dBic	-1.7 dBic	
Average gain (RHCP)	-5.1 dBic	-4.6 dBic	
Average efficiency (RHCP)	31%	34.5%	
Maximum Return Loss	-15 dB	-15 dB	
Maximum VSWR	1.4:1	1.4:1	

Integrated Antenna and RF Solutions

7 Electrical performance

7-1 Return Loss

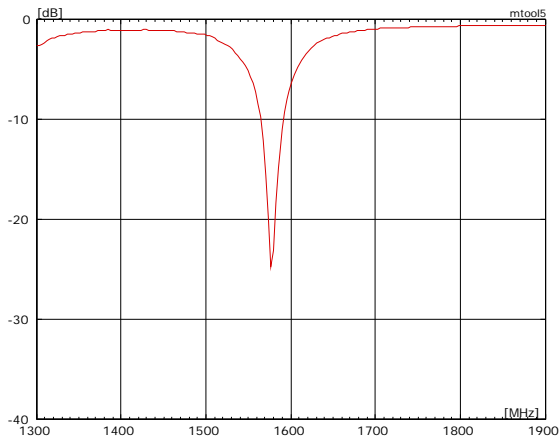

Reference Board A10137-R-U1

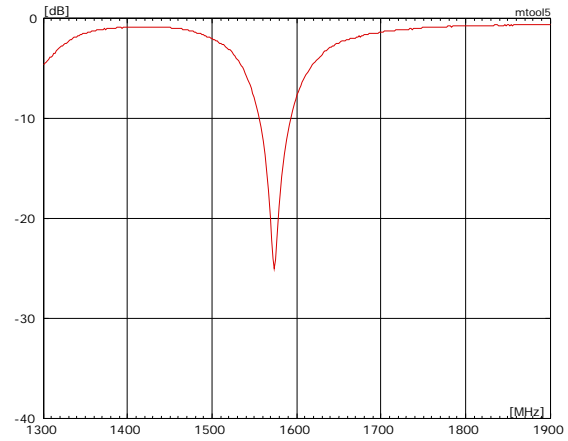

Reference Board A10137-D

7-2 VSWR

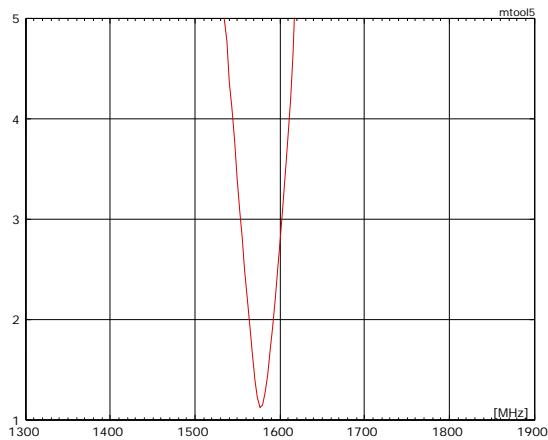

Reference Board A10137-R-U1

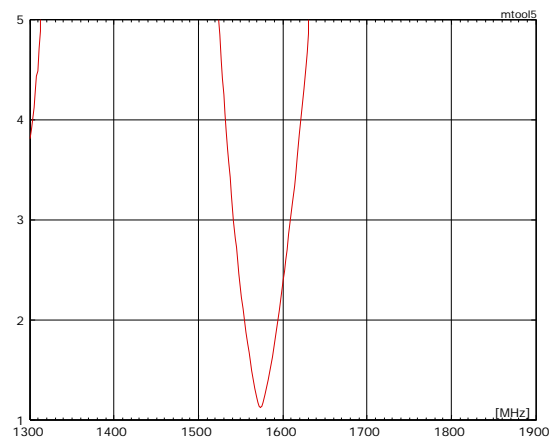

Reference Board A10137-D

7-3 Antenna patterns

7.3.1. Reference Board A10137-R-U1 [Linear Polarization]

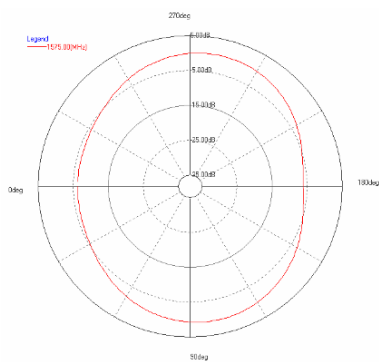
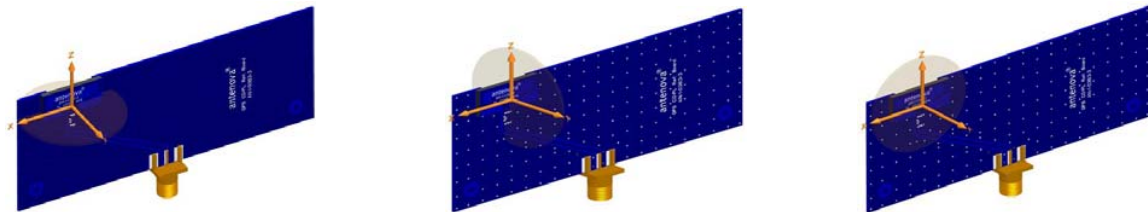
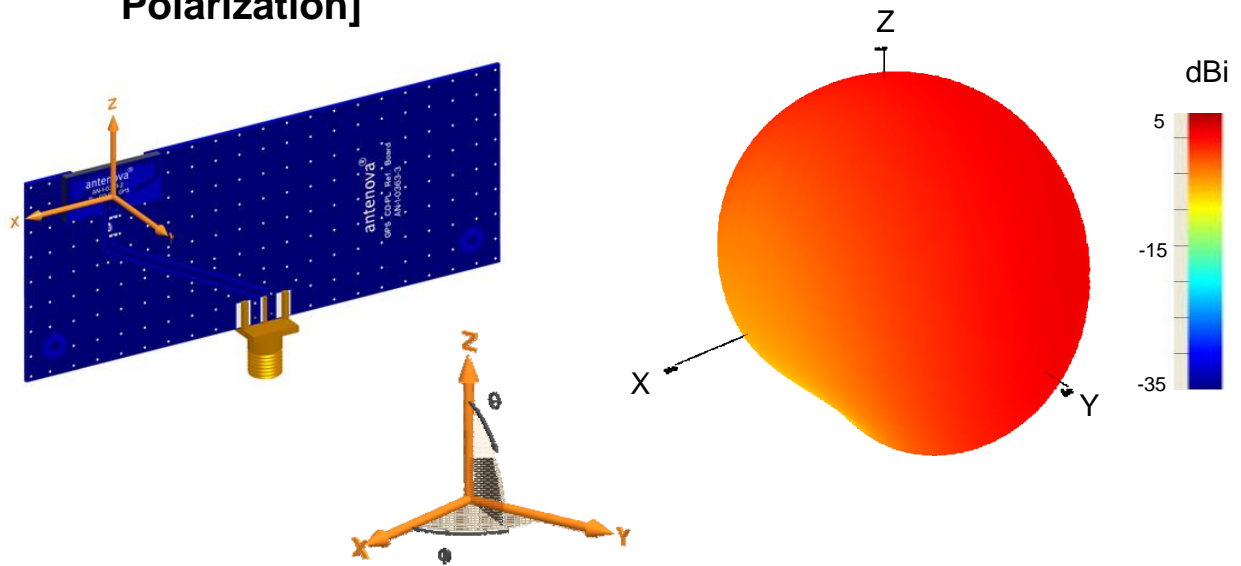

XY plane

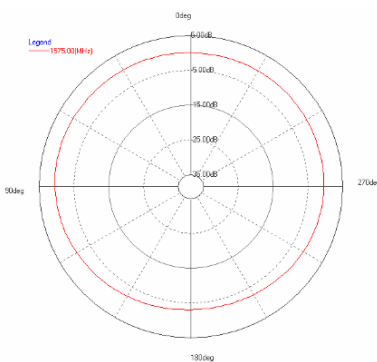

ZY plane

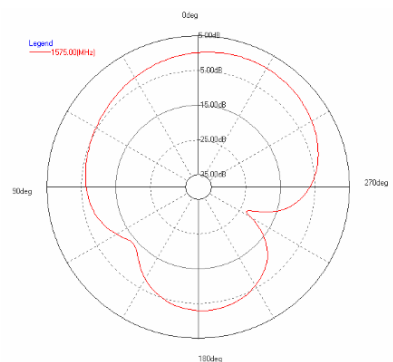

XZ plane

Patterns show combined polarisations
measured on reference board A10137-R-U1

Integrated Antenna and RF Solutions

7.3.2. Reference Board A10137-R-U1 [RHCP]

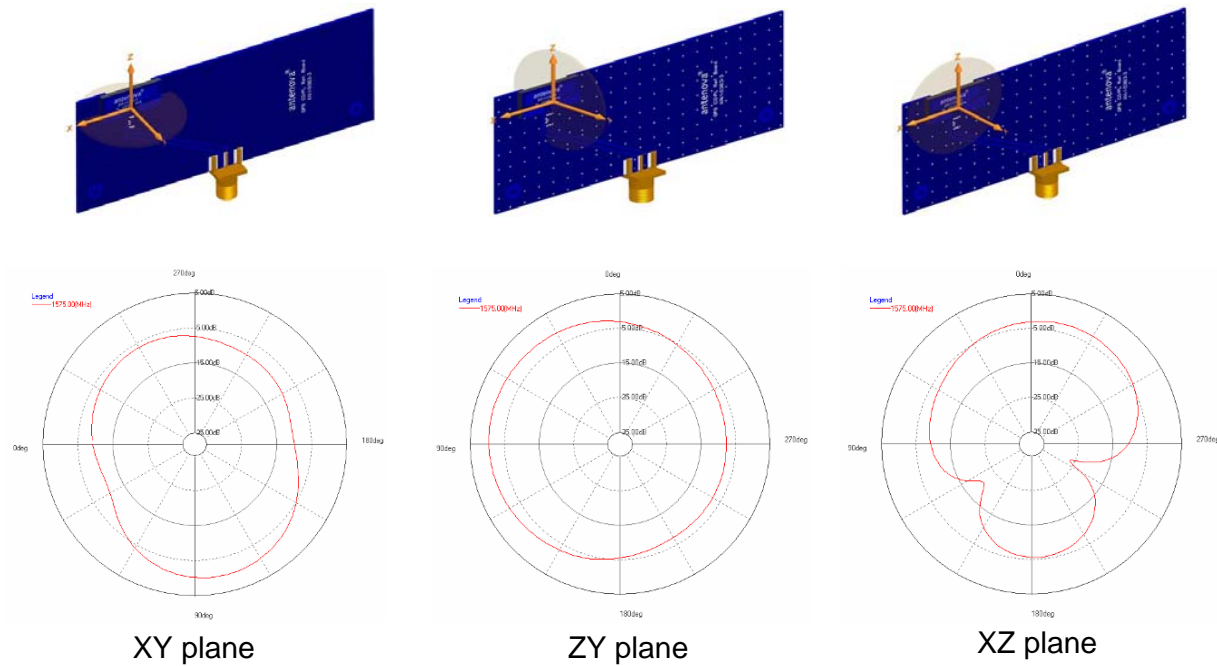
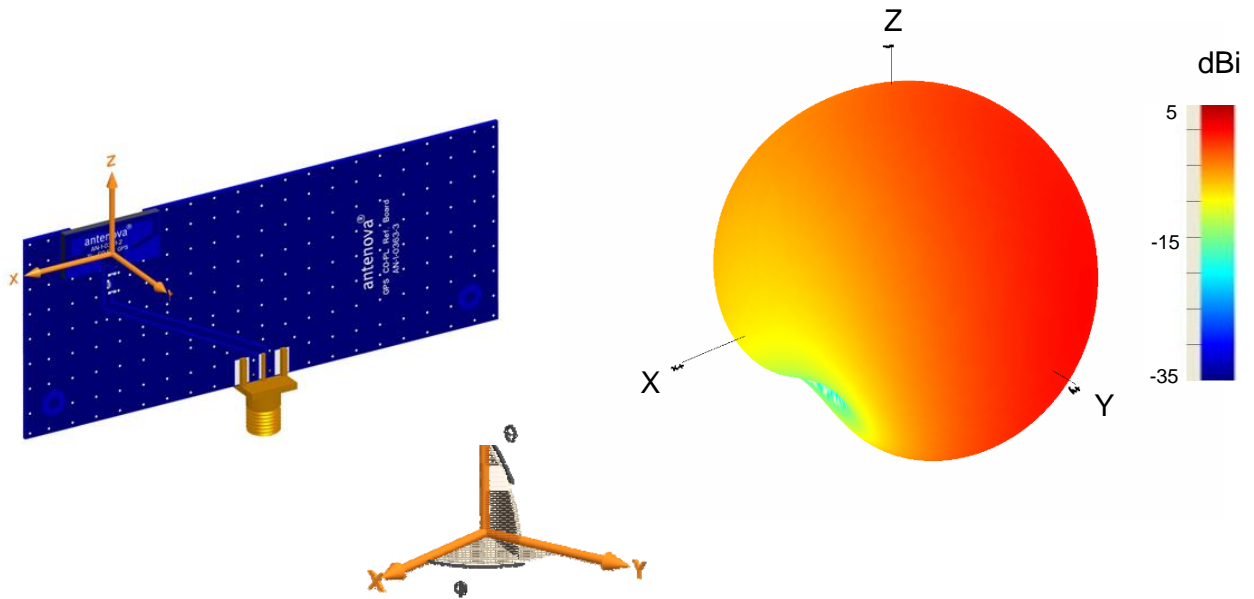

7.3.3. Reference Board A10137-D [Linear Polarization]

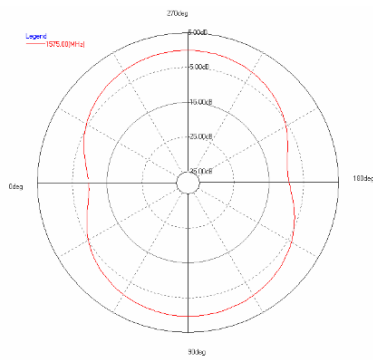
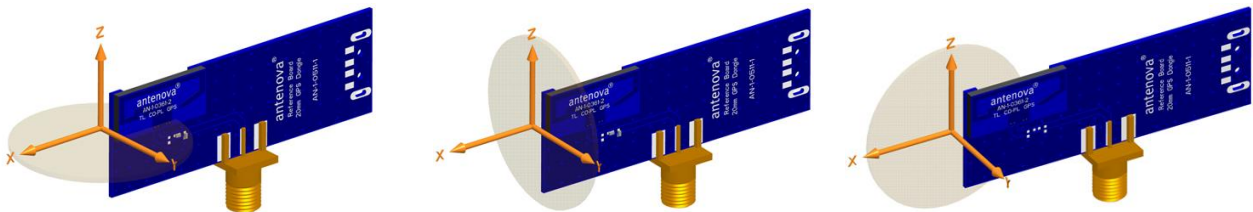
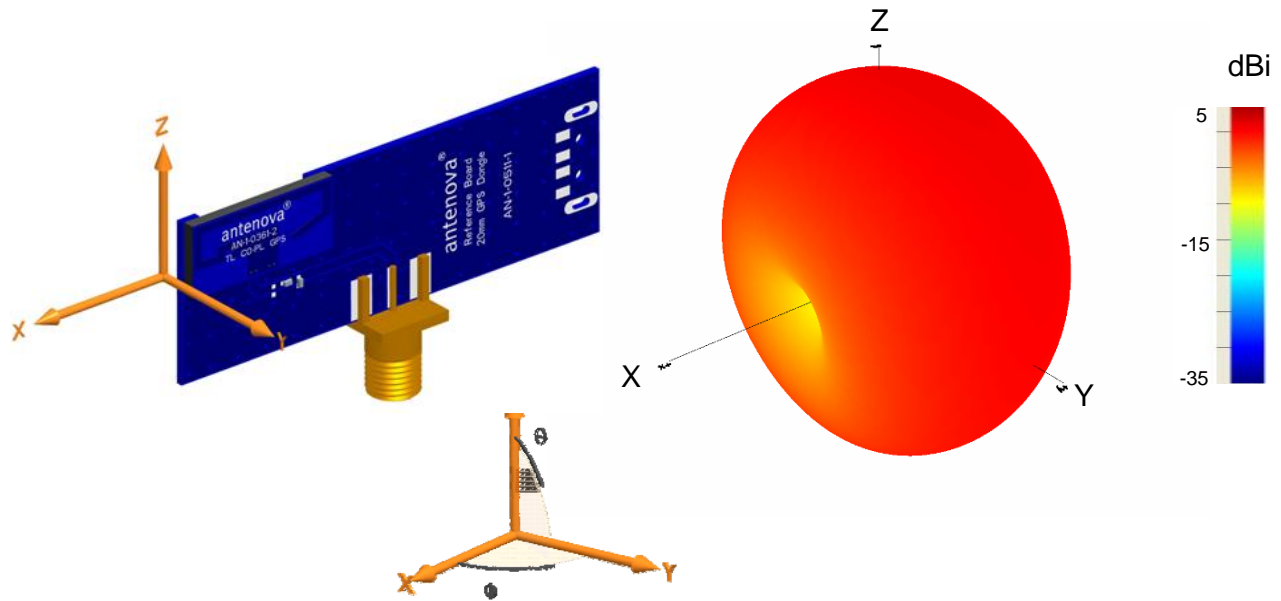

XY plane

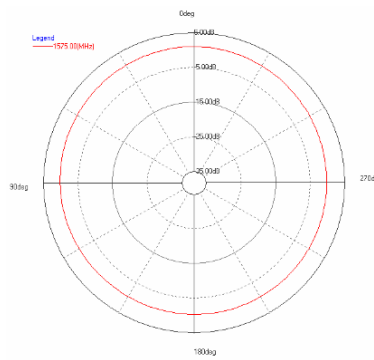

ZY plane

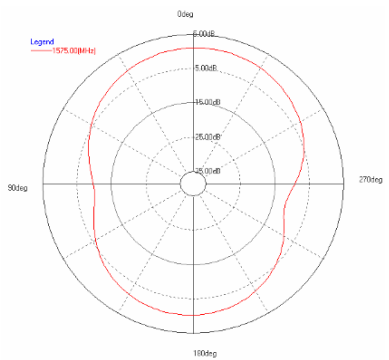

XZ plane

Patterns show combined polarisations measured on reference board A10137-D

7.3.4. Reference Board A10137-D [RHCP]

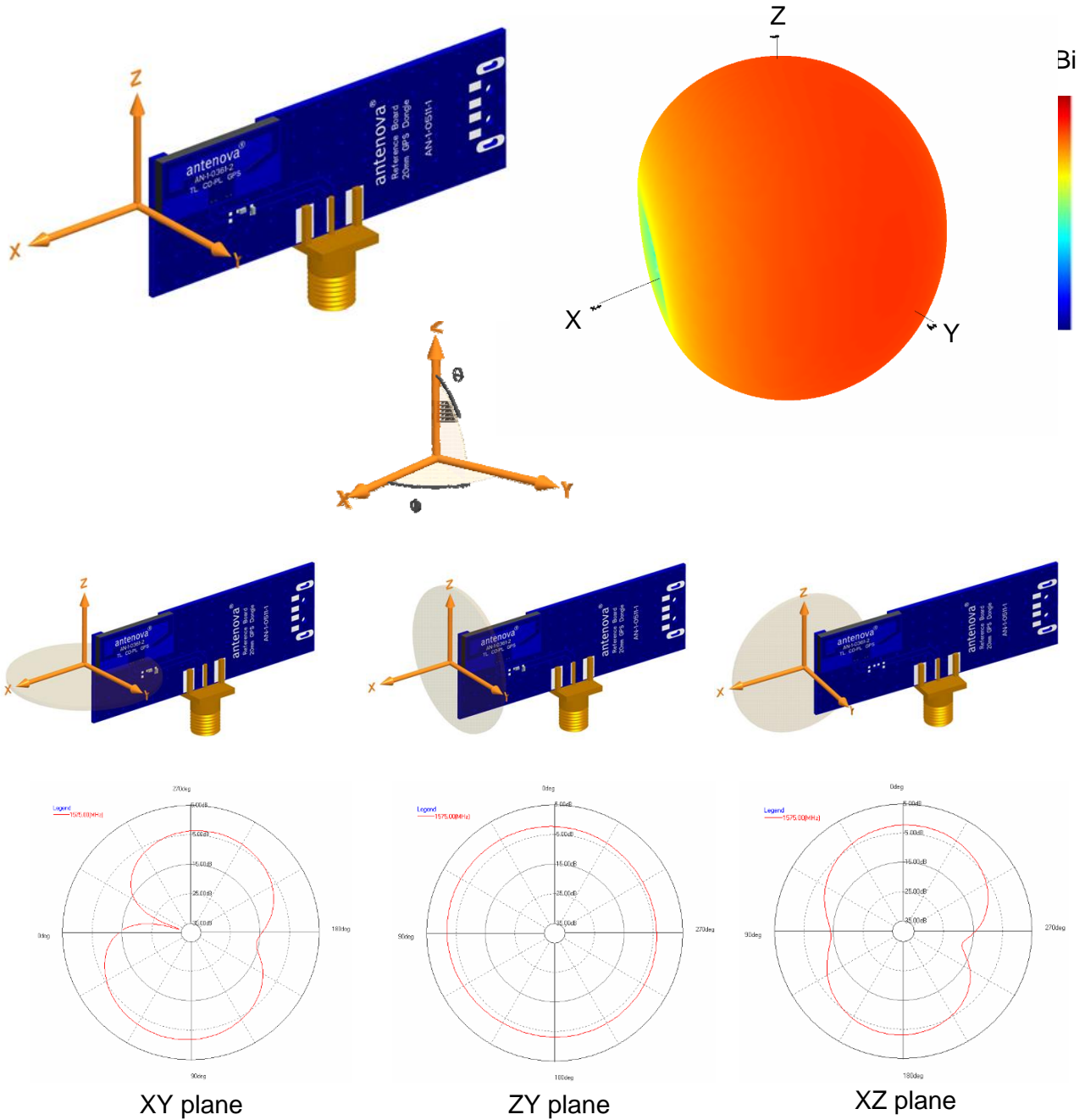

8 Antenna dimensions

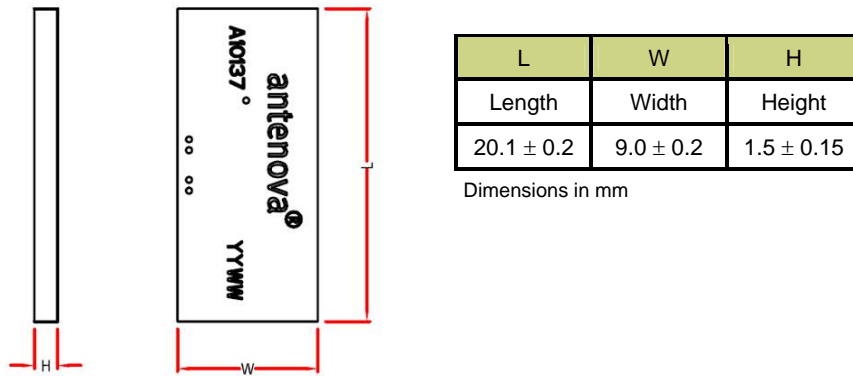

9 Antenna footprint

GPS Co-planar (Part No: A10137)

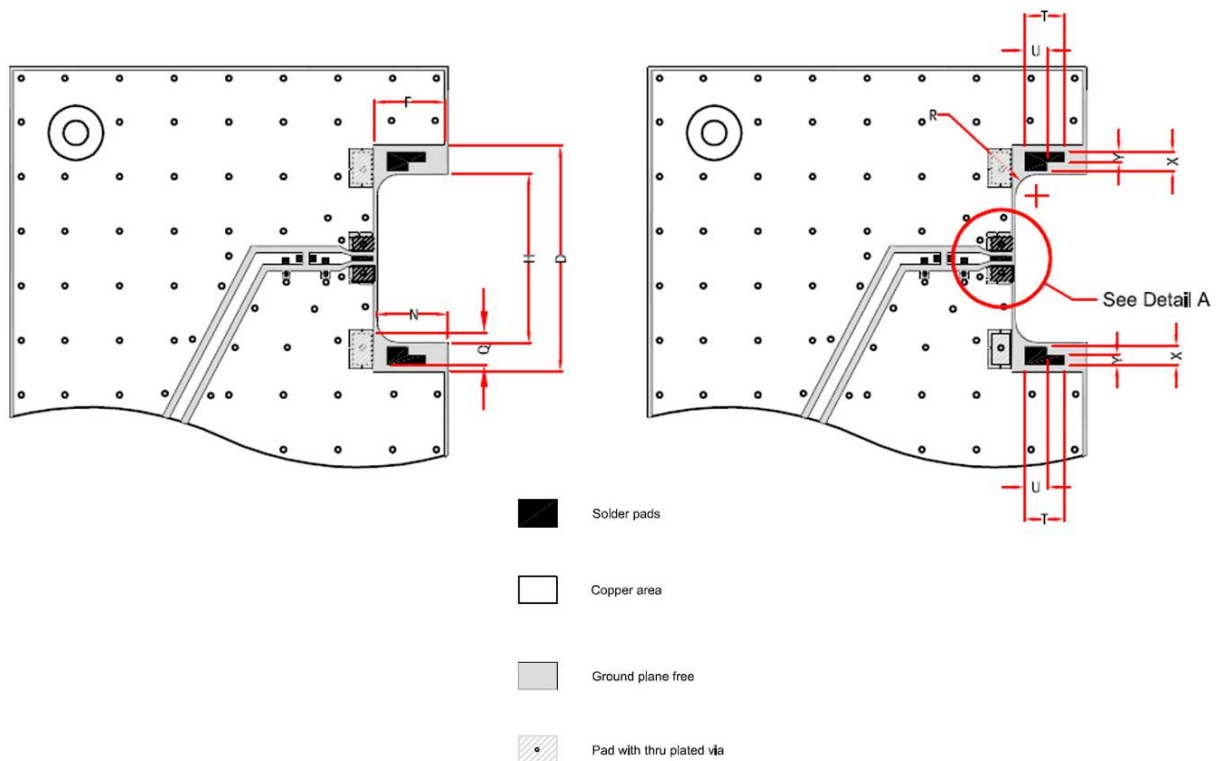

* CAD files of the antenna footprint are available from Antenova on request.
Please contact info@antenova.com for further details.

Integrated Antenna and RF Solutions

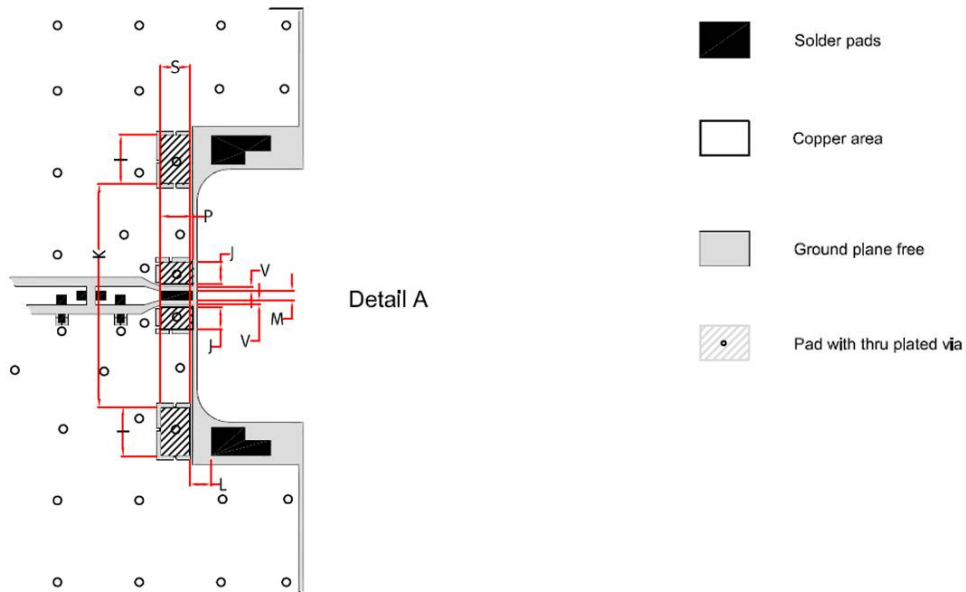

* CAD files of the antenna footprint are available from Antenova on request.
Please contact info@antenova.com for further details.

D	F	I	J	H	K	L	M	N	P	Q	R	S	T	U	V	X	Y
min 20.6	6.5	3.0	1.35	15.5	13.6	1.3	0.6	6.5	2.0	3.0	2.0	1.8	3.68	2.1	0.25	1.8	1.0

Dimensions in mm. Tolerances for all dimensions on this table are ± 0.1 mm.
Dimension D stated is a minimum. Depending on the application, it can be extended to optimise the antenna performance. For more details, please contact info@antenova.com

10 Electrical interface

10-1 Transmission lines

- All transmission lines should be designed to have a characteristic impedance of 50 Ω
- The length of the transmission lines should be kept to a minimum
- Any other parts of the RF system like transceivers, power amplifiers, etc, should also be designed to have an impedance of 50 Ω

Once the material for the PCB has been chosen (PCB thickness and dielectric constant), a coplanar transmission line can easily be designed using any of the commercial software packages for transmission line design. For the chosen PCB thickness, copper thickness and substrate dielectric constant, the program will calculate the appropriate transmission line width and gaps on either side of the track so the characteristic impedance of the coplanar transmission line is 50 Ω .

10-2 Matching circuit

The antenna requires a matching circuit that must be optimized for each customer's product. The matching circuit will require up to three components and the following pad layout should be designed into the device so the correct circuit can be installed:

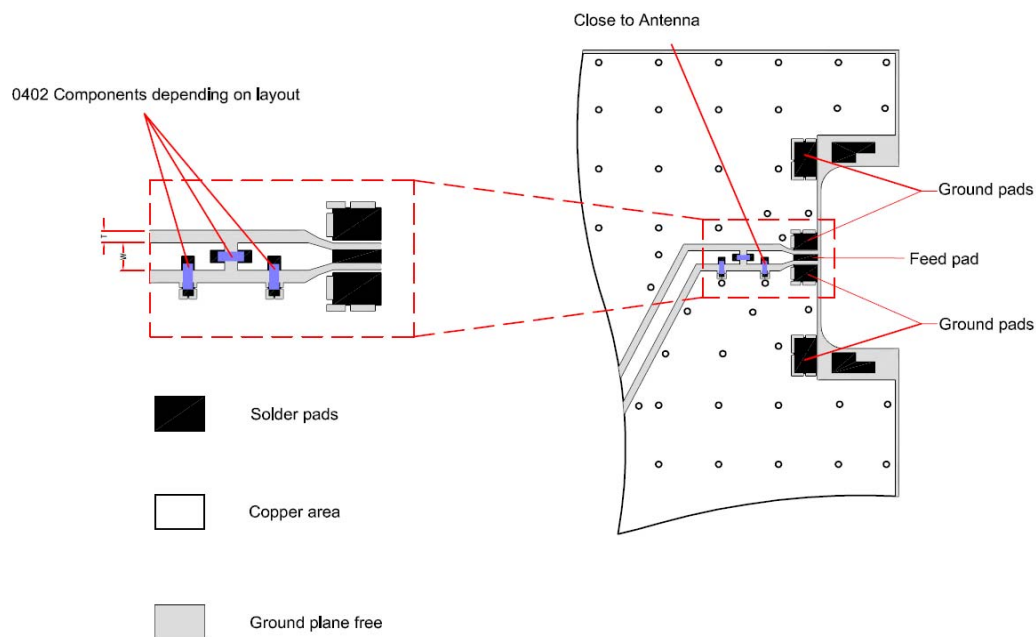

The antenna feed pad and the antenna ground pads are indicated in the drawing above. Additional pads are for mechanical attachment only and should not be grounded.

In addition to the matching circuit, a separate DC blocking capacitor will also be required between the radio and the antenna matching circuit.

Note: The component values for the matching circuit will vary depending on the size of the PCB and surrounding components. The impedance of the antenna should be measured before selecting suitable matching components. Antenova offers this service on request. Contact info@antenova.com for further information.

10-3 Antenna placement

Antenova strongly recommends placing the antenna at the edge of the board with a cut out area as shown in the antenna footprint (Section 9). Maximum antenna performance is achieved by placing the antenna towards one of the corners of the PCB.

10-4 Reference boards

The reference boards have been designed for evaluation purposes of the Cyaneus Co-planar antenna and they include a SMA female connector.

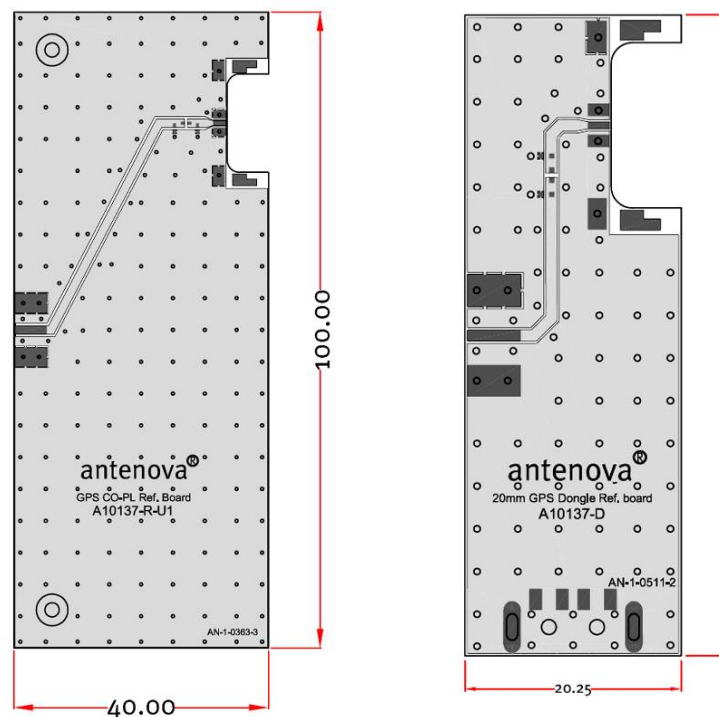

A10137-R-U1

A10137-D

Dimensions in mm

Contact info@antenova.com for further details

11 Soldering

This antenna is suitable for lead free soldering.

The reflow profile should be adjusted to suit the device, oven and solder paste, while observing the following conditions:

- The maximum temperature should not exceed 240 °C
- However for lead free soldering, a maximum temperature of 255 °C for no more than 20 seconds is permitted.
- The antenna should not be exposed to temperatures exceeding 120 °C more than 3 times during the soldering process.

12 Hazardous material regulation conformance

The antenna has been tested to conform to RoHS requirements. A certificate of conformance is available from Antenova's website.

13 Packaging

13-1 Optimal storage conditions for packaged reels

Temperature	-10°C to 40°C
Humidity	Less than 75% RH
Shelf Life	18 Months
Storage place	Away from corrosive gas and direct sunlight
Packaging	Reels should be stored in unopened sealed manufacturer's plastic packaging.

Note: Storage of open reels of antennas is not recommended due to possible oxidization of pads on antennas. If short term storage is necessary, then it is highly recommended that the bag containing the antenna reel is re-sealed and stored in like storage conditions as in above table.

13-2 Tape characteristics

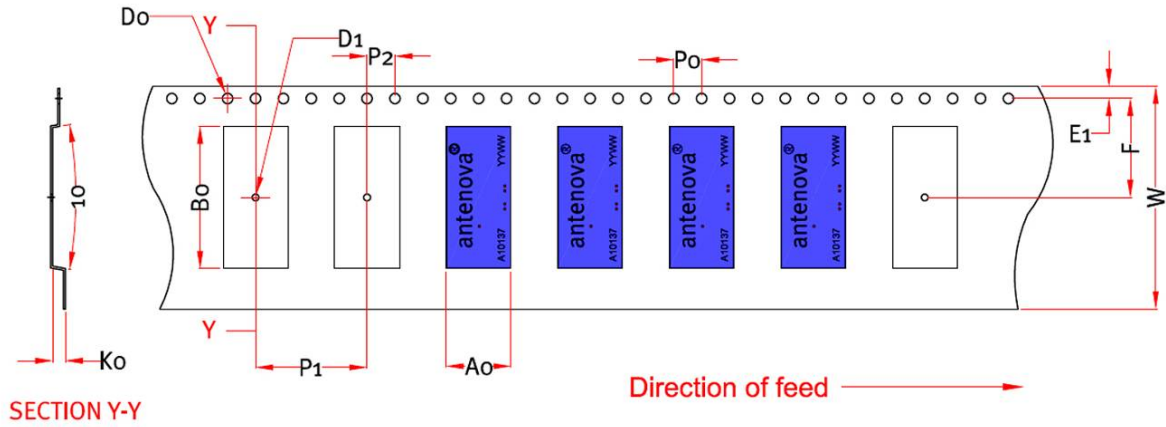

W	F	E1	P0	P1	P2	A0	B0	K0	T	D0	D1
32 ± 0.2	14.2 ± 0.1	1.75 ± 0.1	4 ± 0.1	16 ± 0.1	2 ± 0.1	9.3 ± 0.1	20.4 ± 0.1	1.8 ± 0.1	0.3 ± 0.05	Min 1.5	Min 1.5

Dimensions in mm

Quantity	Leading Space	Trailing Space
1000 pcs / reel	50 blank antenna holders	50 blank antenna holders

13-3 Reel dimensions

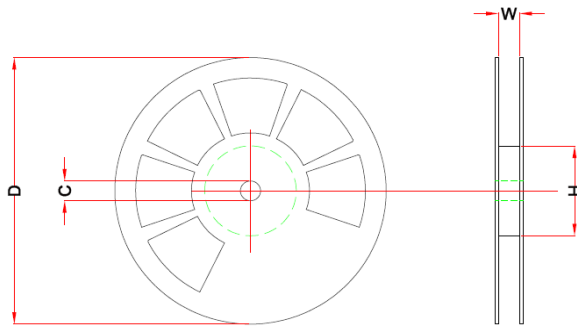

Width (W)	Reel Diameter (D)	Hub Diameter (H)	Shaft Diameter (C)
33.5 mm	330 mm (13")	80 mm	13 mm

13-4 Box dimensions



Width (W)	Breadth (B)	Thickness (H)
345 mm	345 mm	45 mm

13-5 Bag properties

Reels are supplied in protective plastic packaging

13-6 Reel label information

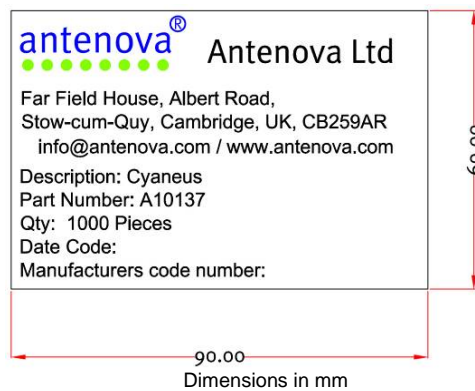



www.antenova.com

Corporate Headquarters

Antenova Ltd.
Far Field House
Albert Road
Stow-cum-Quy
Cambridge
CB25 9AR

Tel: +44 1223 810600
Fax: +44 1223 810650
Email: info@antenova.com

North America Headquarters

Antenova Ltd.
Rogers Business Park
2541 Technology Drive Suite 403
Elgin, IL 60124

Tel: +1 (847) 551 9710
Fax: +1 (847) 551 9719
Email: info@antenova.com

Asia Headquarters

Antenova Asia Ltd.
4F, No. 324, Sec. 1, Nei-Hu Road
Nei-Hu District
Taipei 11493
Taiwan, ROC

Tel: +886 (0) 2 8797 8630
Fax: +886 (0) 2 8797 6890
Email: info@antenova.com

Copyright® 2009 Antenova Ltd. All Rights Reserved. Antenova® and gigaNOVA® are trademarks of Antenova Ltd. Any other names and/or trademarks belong to their respective companies.

The materials provided herein are believed to be reliable and correct at the time of print. Antenova does not warrant the accuracy or completeness of the information, text, graphics or other items contained within these information. Antenova further assumes no responsibility for the use of this information, and all such information shall be entirely at the user's risk.



Certificate No: 4598

Integrated Antenna and RF Solutions