

Description

AH173 is a single-digital-output Hall-Effect latch sensor with pull-up resistor for high temperature operation. The device includes an on-chip Hall voltage generator for magnetic sensing, an amplifier to amplify Hall voltage, a comparator to provide switching hysteresis for noise rejection, and an output driver with a pull-up resistor (R_{pu}). An internal band-gap regulator provides a temperature compensated supply voltage for internal circuits and allows a wide operating supply range.

When the magnetic flux density (**B**) is larger than operate point (**B_{op}**), output is switched on (OUT pin is pulled low). The output state is held on until a magnetic flux density reversal falls below Br_p. When **B** is less than Br_p, the output is switched off.

The AH173 is available in SIP-3L and SC59 packages.

Features

- Bipolar Hall-Effect latch sensor
- 3V to 20V DC operating voltage
- Built-in pull-up resistor
- 25mA output sink current
- Operating temperature: -40°C to +125°C
- SIP-3L and SC59 packages (SC59 is commonly known as SOT23 in Asia)
- Green Molding Compound (No Br, Sb) (Note 1)

Notes: 1. EU Directive 2002/95/EC (RoHS). All applicable RoHS exemptions applied. Please visit our website at http://www.diodes.com/products/lead_free.html.

Pin Assignments

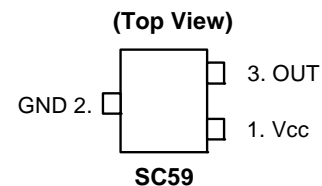
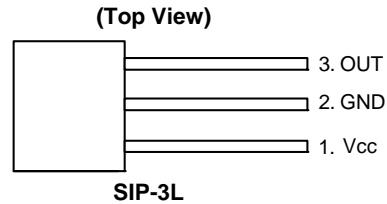

Applications

- Rotor Position Sensing
- Current Switch
- Encoder
- RPM Detection

Typical Application Circuit

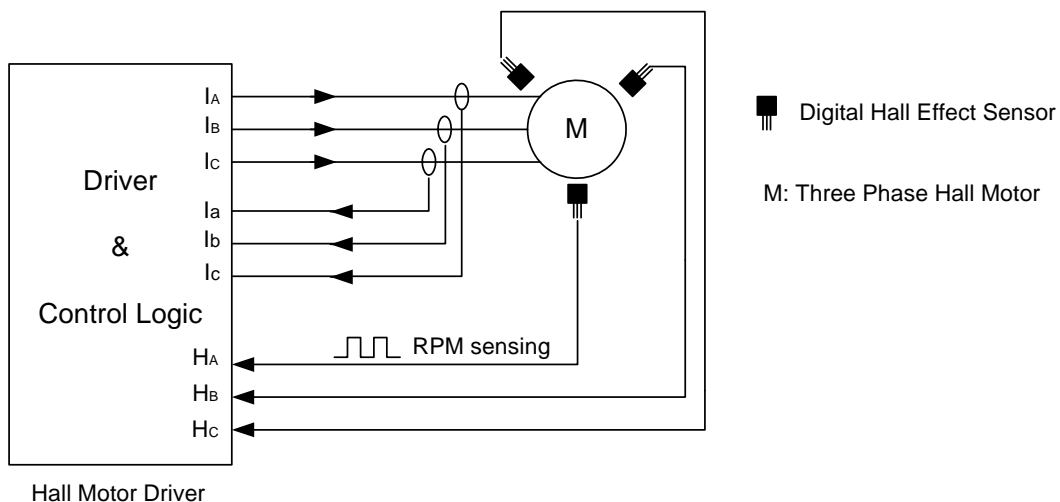

Pin Descriptions

Pin Name	Pin #	Description
V _{CC}	1	Positive Power Supply
GND	2	Ground
OUT	3	Output Stage

Functional Block Diagram

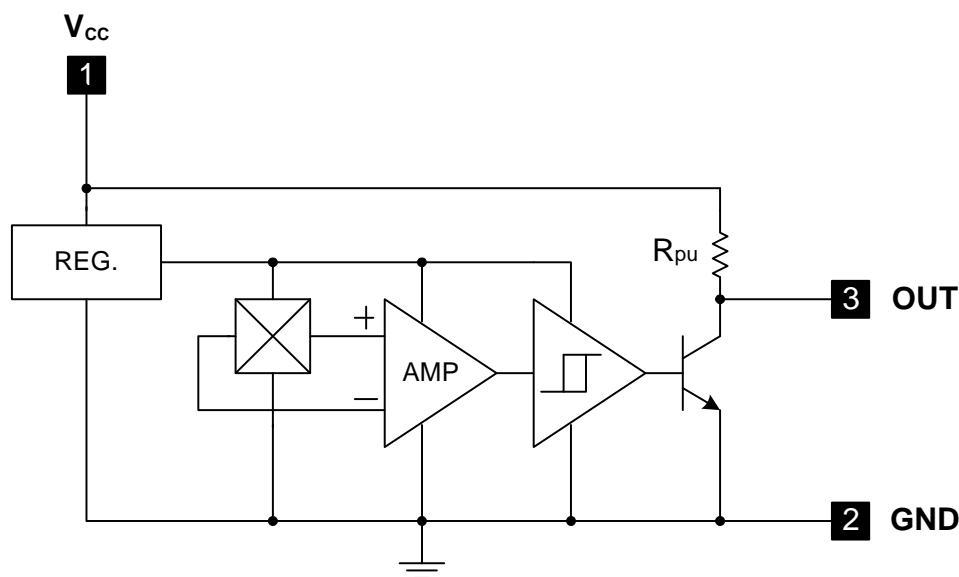

Absolute Maximum Ratings (T_A = 25°C)

Symbol	Characteristics	Values	Unit	
V _{CC}	Supply Voltage	20	V	
V _{OUT} (off)	Output "Off" Voltage	20	V	
I _O (sink)	Output "On" Current	25	mA	
T _S	Storage Temperature Range	-65~+150	°C	
T _J	Maximum Junction Temperature	+150	°C	
P _D	Power Dissipation	SIP-3L	550	mW
		SC59	230	mW

Recommended Operating Conditions

Symbol	Characteristic	Conditions	Min	Max	Unit
V _{CC}	Supply Voltage	Operating	3	20	V
T _A	Operating Ambient Temperature	Operating	-40	125	°C

Electrical Characteristics (T_A = 25°C)

Symbol	Characteristics	Conditions	Min	Typ.	Max	Unit
V _{OUT (SAT)}	Output Saturation Voltage	V _{CC} = 12V, OUT "ON" I _O = 10mA	-	300	400	mV
I _{CC}	Supply Current	V _{CC} = 12V, OUT "OFF"	-	3.5	6	mA
R _{pu}	Internal Pull-up Resistor		7	10	13	KΩ
V _d	Dropout Voltage	V _d = V _{CC} - V _{Ce}	-	-	0.3	V

Magnetic Characteristics (T_A = 25°C, V_{CC} = 12V, unless otherwise specified, Note 2)

(1mT = 10 Gauss)

A grade

Symbol	Parameter	Min	Typ.	Max	Unit
B _{ops} (south pole to brand side)	Operation Point	15	-	60	Gauss
B _{rps} (south pole to brand side)	Release Point	-60	-	-15	Gauss
B _{hy} (B _{opx} - B _{rpx})	Hysteresis	-	80	-	Gauss

B grade

Symbol	Parameter	Min	Typ.	Max	Unit
B _{ops} (south pole to brand side)	Operation Point	5	-	80	Gauss
B _{rps} (south pole to brand side)	Release Point	-80	-	-5	Gauss
B _{hy} (B _{opx} - B _{rpx})	Hysteresis	-	80	-	Gauss

Notes: 2. Magnetic characteristics may vary with supply voltage, operating temperature and after soldering.

Operating Characteristics

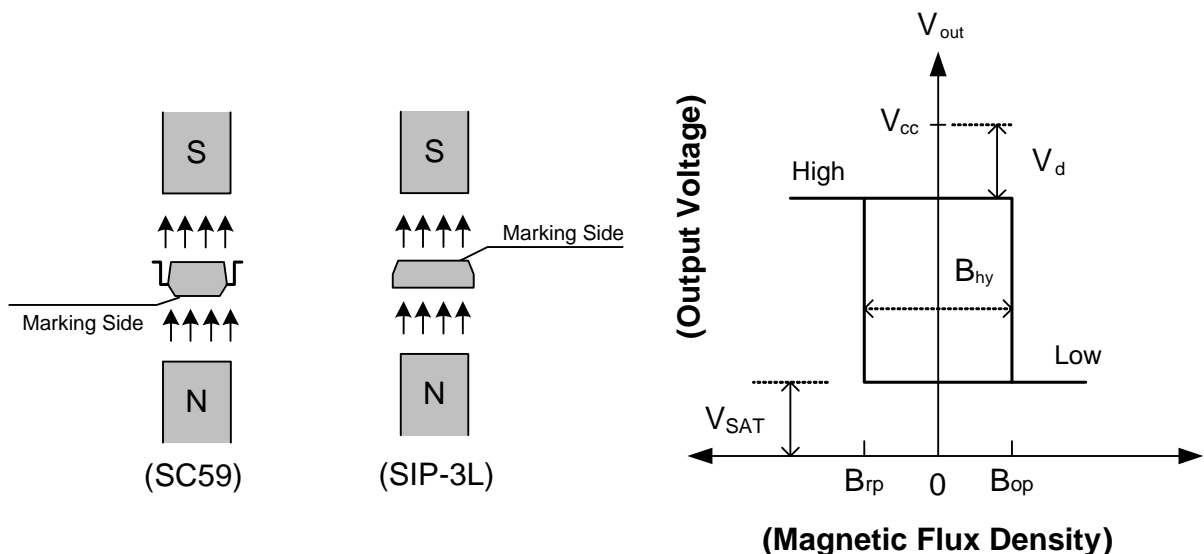

Performance Characteristics

(1) SIP-3L

T_A (°C)	25	50	60	70	80	85	90	95	100
P_D (mW)	550	440	396	352	308	286	264	242	220
T_A (°C)	105	110	115	120	125	130	135	140	150
P_D (mW)	198	176	154	132	110	88	66	44	0

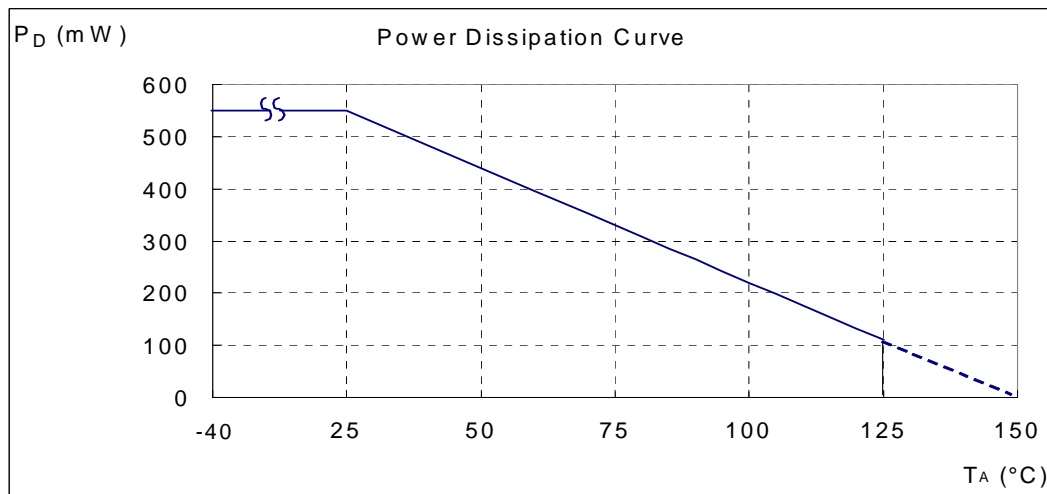





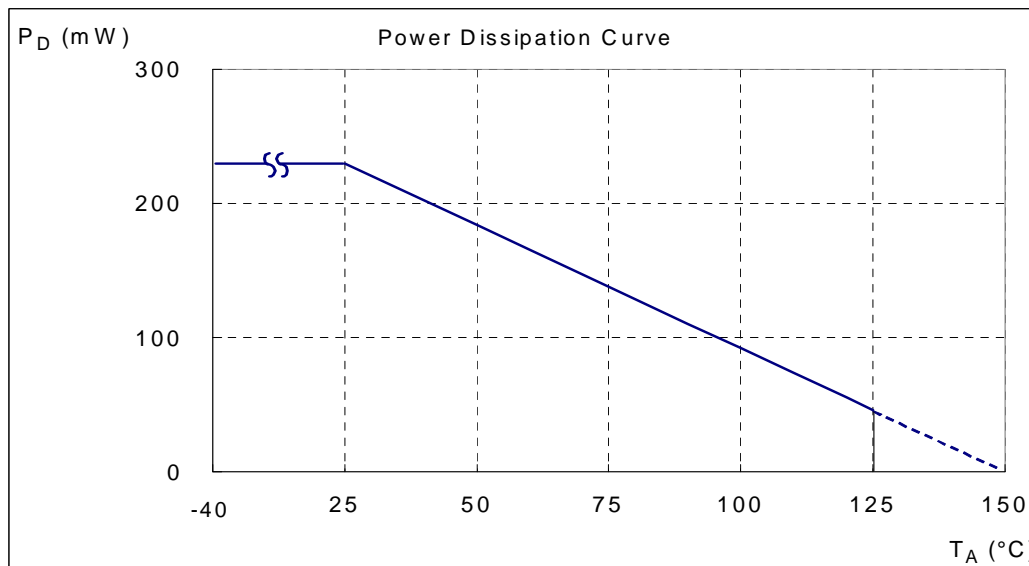



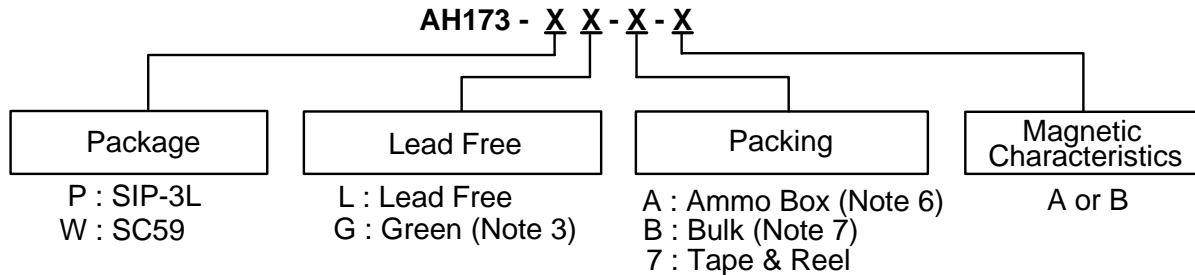



(2) SC59 (commonly known as SOT23 in Asia)

T_A (°C)	25	50	60	70	80	85	90	100	110	120	130	140	150
P_D (mW)	230	184	166	147	129	120	110	92	74	55	37	18	0



Ordering Information



Device	Package Code	Packaging (Note 4, 5)	Tube/Bulk		7" Tape and Reel		Ammo Box		Magnetic Characteristics
			Quantity	Part Number Suffix	Quantity	Part Number Suffix	Quantity	Part Number Suffix	
 AH173-PL-A-A	P	SIP-3L	NA	NA	NA	NA	4000/Box	-A	A
 AH173-PL-A-B	P	SIP-3L	NA	NA	NA	NA	4000/Box	-A	B
 AH173-PG-A-A	P	SIP-3L	NA	NA	NA	NA	4000/Box	-A	A
 AH173-PG-A-B	P	SIP-3L	NA	NA	NA	NA	4000/Box	-A	B
 AH173-PL-B-A	P	SIP-3L	1000	-B	NA	NA	NA	NA	A
 AH173-PL-B-B	P	SIP-3L	1000	-B	NA	NA	NA	NA	B
 AH173-PG-B-A	P	SIP-3L	1000	-B	NA	NA	NA	NA	A
 AH173-PG-B-B	P	SIP-3L	1000	-B	NA	NA	NA	NA	B
 AH173-WL-7-A	W	SC59	NA	NA	3000/Tape & Reel	-7	NA	NA	A
 AH173-WL-7-B	W	SC59	NA	NA	3000/Tape & Reel	-7	NA	NA	B
 AH173-WG-7-A	W	SC59	NA	NA	3000/Tape & Reel	-7	NA	NA	A
 AH173-WG-7-B	W	SC59	NA	NA	3000/Tape & Reel	-7	NA	NA	B

- Notes:
- EU Directive 2002/95/EC (RoHS). All applicable RoHS exemptions applied. Please visit our website at http://www.diodes.com/products/lead_free.html.
 - Pad layout as shown on Diodes Inc. suggested pad layout document AP02001, which can be found on our website at <http://www.diodes.com/datasheets/ap02001.pdf>.
 - Reverse taping as shown on Diodes Inc. Surface Mount (SMD) Packaging document AP02007, which can be found on our website <http://www.diodes.com/datasheets/ap02007.pdf>.
 - Ammo Box is for SIP-3L Spread Lead.
 - Bulk is for SIP-3L Straight Lead.

Marking Information

(1) SIP-3L

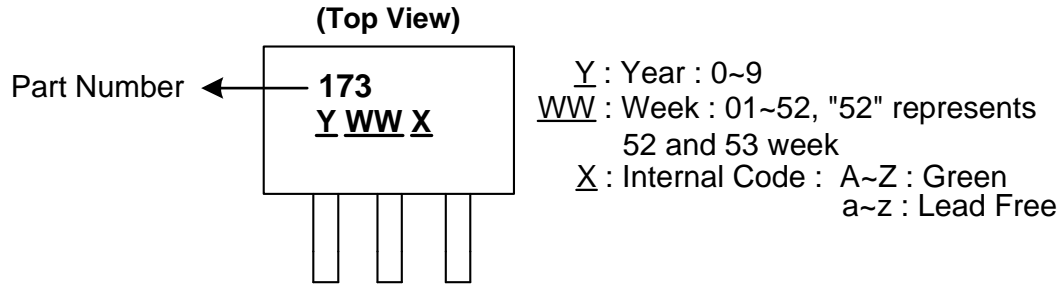

(2) SC59 (Commonly known as SOT23 in Asia)

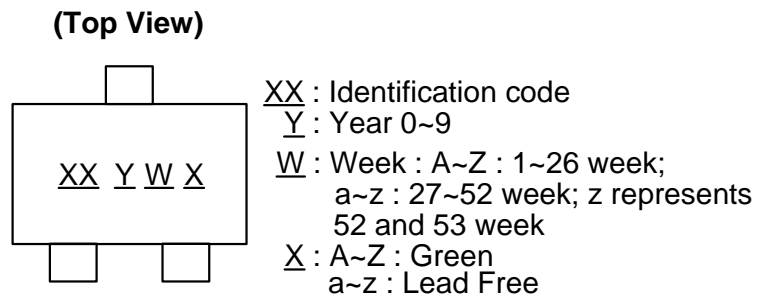

Part Number	Package	Identification Code
AH173	SC59	J3

Package Outline Dimensions (All Dimensions in mm)

(1) Package Type: SIP-3L for Bulk pack

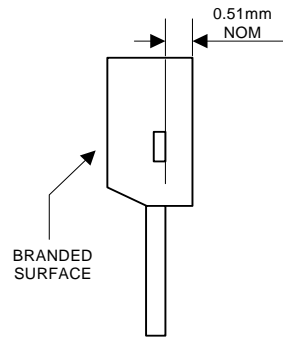

Active Area Depth

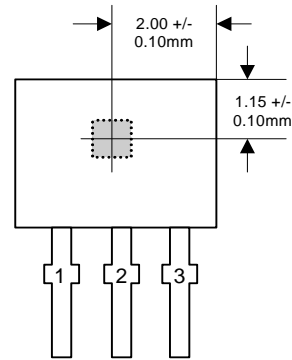

Sensor Location

Package Dimension

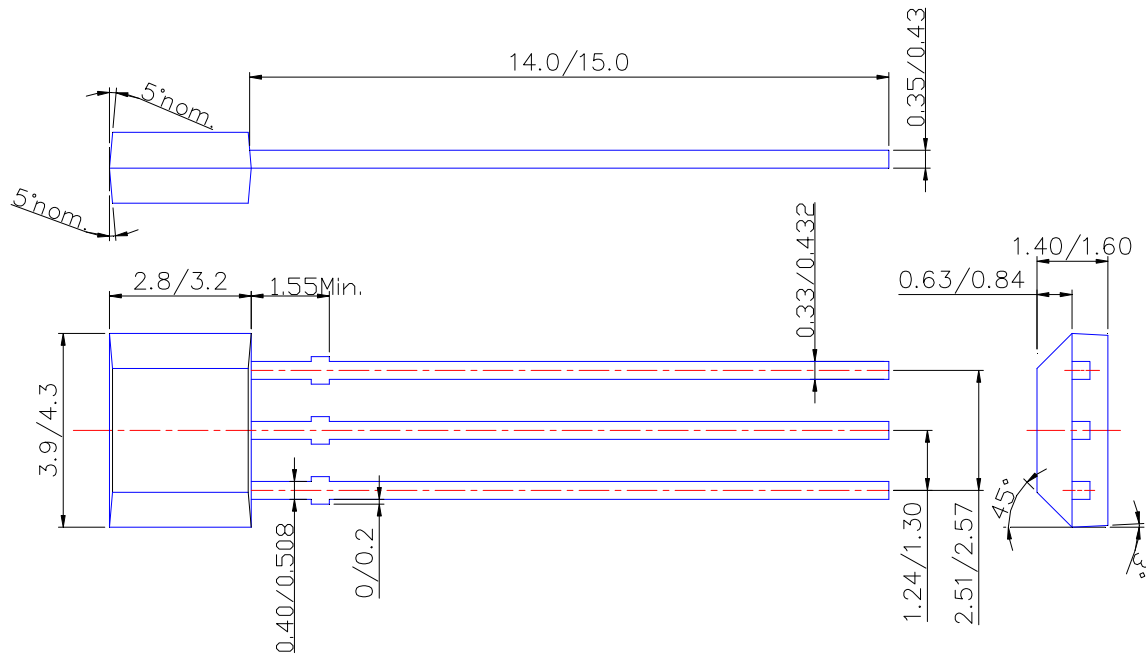

Package Outline Dimensions (Continued)

(2) Package Type: SIP-3L for Ammo pack

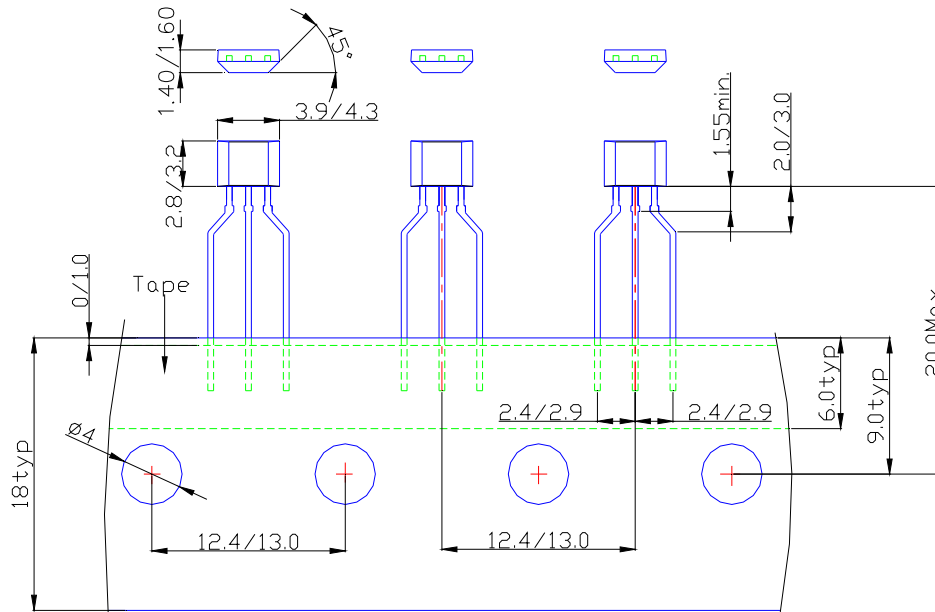

(3) SC59 (Commonly known as SOT23 in Asia)

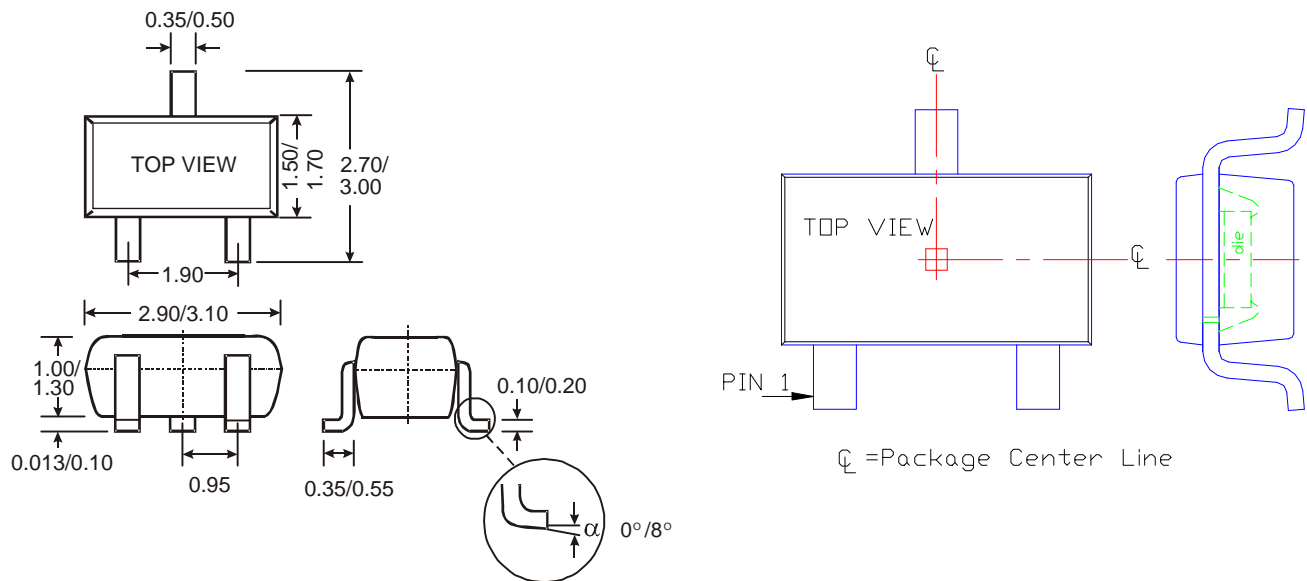

IMPORTANT NOTICE

DIODES INCORPORATED MAKES NO WARRANTY OF ANY KIND, EXPRESS OR IMPLIED, WITH REGARDS TO THIS DOCUMENT, INCLUDING, BUT NOT LIMITED TO, THE IMPLIED WARRANTIES OF MERCHANTABILITY AND FITNESS FOR A PARTICULAR PURPOSE (AND THEIR EQUIVALENTS UNDER THE LAWS OF ANY JURISDICTION).

Diodes Incorporated and its subsidiaries reserve the right to make modifications, enhancements, improvements, corrections or other changes without further notice to this document and any product described herein. Diodes Incorporated does not assume any liability arising out of the application or use of this document or any product described herein; neither does Diodes Incorporated convey any license under its patent or trademark rights, nor the rights of others. Any Customer or user of this document or products described herein in such applications shall assume all risks of such use and will agree to hold Diodes Incorporated and all the companies whose products are represented on Diodes Incorporated website, harmless against all damages.

Diodes Incorporated does not warrant or accept any liability whatsoever in respect of any products purchased through unauthorized sales channel.

Should Customers purchase or use Diodes Incorporated products for any unintended or unauthorized application, Customers shall indemnify and hold Diodes Incorporated and its representatives harmless against all claims, damages, expenses, and attorney fees arising out of, directly or indirectly, any claim of personal injury or death associated with such unintended or unauthorized application.

Products described herein may be covered by one or more United States, international or foreign patents pending. Product names and markings noted herein may also be covered by one or more United States, international or foreign trademarks.

LIFE SUPPORT

Diodes Incorporated products are specifically not authorized for use as critical components in life support devices or systems without the express written approval of the Chief Executive Officer of Diodes Incorporated. As used herein:

A. Life support devices or systems are devices or systems which:

1. are intended to implant into the body, or
2. support or sustain life and whose failure to perform when properly used in accordance with instructions for use provided in the labeling can be reasonably expected to result in significant injury to the user.

B. A critical component is any component in a life support device or system whose failure to perform can be reasonably expected to cause the failure of the life support device or to affect its safety or effectiveness.

Customers represent that they have all necessary expertise in the safety and regulatory ramifications of their life support devices or systems, and acknowledge and agree that they are solely responsible for all legal, regulatory and safety-related requirements concerning their products and any use of Diodes Incorporated products in such safety-critical, life support devices or systems, notwithstanding any devices- or systems-related information or support that may be provided by Diodes Incorporated. Further, Customers must fully indemnify Diodes Incorporated and its representatives against any damages arising out of the use of Diodes Incorporated products in such safety-critical, life support devices or systems.

Copyright © 2010, Diodes Incorporated

www.diodes.com