



SP6669

1.5MHZ, 600mA SYNCHRONOUS STEP DOWN CONVERTER

FEATURES

- Up to 600mA Output Current
 - Up to 95% Efficiency
 - 1.5MHz Constant Frequency Operation
 - Low Dropout Operation Mode: 100% Duty Cycle
- Output Voltages as low as 0.6V
- No Schottky Diode Required
- 200µA Quiescent Current (no load)
- Excellent Line and Load Transient Response
- Over-Temperature Protection
- 2.5V to 5.5V Input Voltage Range
- Lead Free SOT23-5 Package

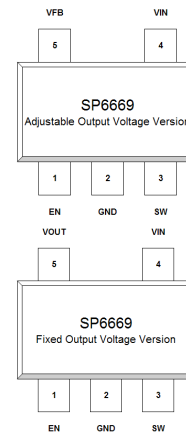

APPLICATIONS

- Cellular Phones
- Wireless Networking
- Digital Cameras
- Portable Media Players
- Bluetooth Devices
- Portable Instruments



DESCRIPTION

The SP6669 is a 600mA synchronous buck converter using a constant frequency current mode architecture with pulse width modulation (PWM) for low output voltage ripple and fixed frequency noise, a pulse skip mode (PSM) for light load efficiency and a LDO mode for 100% duty cycle. With a 2.5V to 5.5V input voltage range and a 1.5MHz switching frequency, the SP6669 allows the use of small surface mount inductors and capacitors ideal for battery powered portable applications. The internal synchronous switch increases efficiency and eliminates the need for an external Schottky diode. Low output voltages are easily supported with the 0.6V feedback reference voltage. The SP6669 is available in an adjustable output voltage version, using an external resistor divider circuit, as well as fixed output voltage versions of 1.2V, 1.5V and 1.8V. The SP6669 is available in a 5 pin SOT-23 package.

TYPICAL APPLICATION CIRCUIT

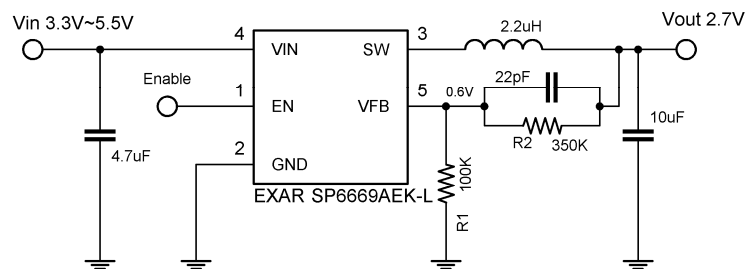

BLOCK DIAGRAM

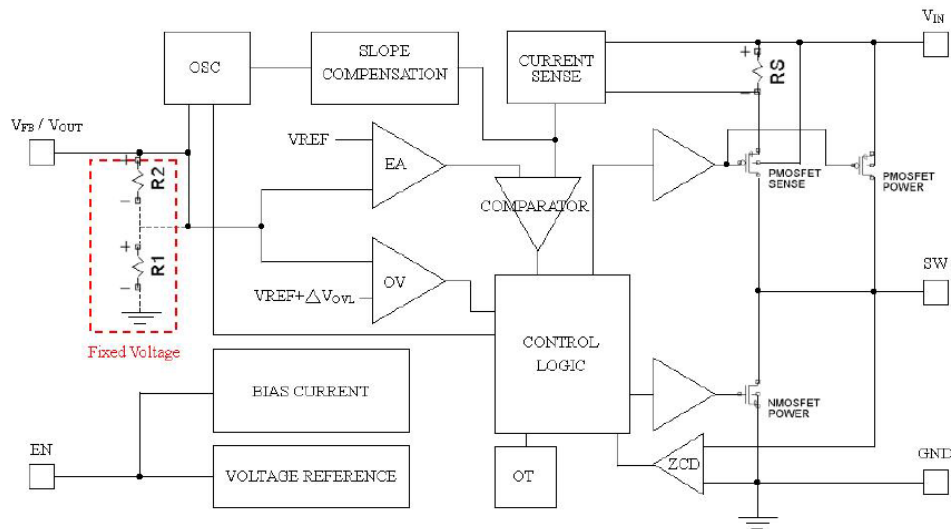
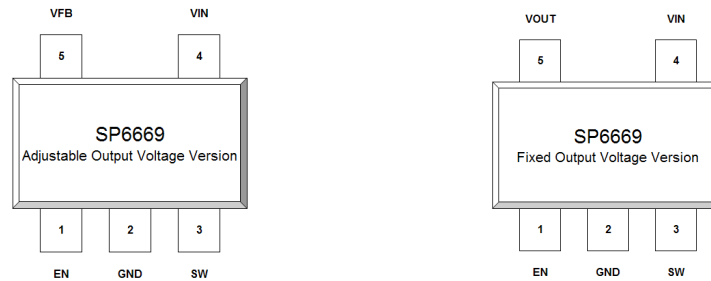

Fig.1: SP6669 Block Diagram

PIN DESCRIPTION

SOT23-5L



Pin Number	Name	Description
1	EN	Enable Pin. Do not leave the pin floating. $V_{EN} < 0.4V$: Shutdown mode $V_{EN} > 1.2V$: Device enabled
2	GND	Ground Signal Pin.
3	SW	Switching node.
4	VIN	Power Supply Pin. Must be decoupled to ground with a $4.7\mu F$ or greater ceramic capacitor.
5	VFB	Adjustable Version Feedback Input Pin. Connect VFB to the center point of the resistor divider.
	VOUT	Fixed Output Voltage Version, Output Voltage Pin. An internal resistive divider divides the output voltage down for comparison to the internal reference voltage.

ELECTRICAL CHARACTERISTICS

Absolute Maximum Ratings

These are stress ratings only and functional operation is not implied. Exposure to absolute maximum ratings for prolonged time periods may affect device reliability. All voltages are with respect to ground.

Input Voltage V_{IN}	-0.3V to 6V	Operating Junction Temp. (Note 1).....	125°C
EN V_{FB} Voltage	-0.3V to V_{IN}	Storage Temp. Range T_{STG}	-65°C to 150°C
SW Voltage.....	-0.3V to ($V_{IN} + 0.3V$)	Lead Temperature (sold. 10s) T_{LEAD}	300°C
PMOS Switch Source Current (DC)	800mA	Thermal Resistance	
NMOS Switch Sink Current (DC)	800mA	$R_{\theta JA}$	250°C/W
Peak Switch Sink and Source Current	1.3A	$R_{\theta JC}$	90°C/W

Note 1: T_J is a function of the ambient temperature T_A and power dissipation P_D ($T_J = T_A + P_D \times 250^\circ\text{C/W}$).

Recommended Operating Conditions

Operating Temperature T_{OP}

-40°C to 85 °C	Input voltage V_{IN}	2.5V to 5.5V
----------------	------------------------------	--------------

$V_{IN}=3.6V$, $T_A=25^\circ\text{C}$, unless otherwise specified – Boldface characters apply over the full temperature range.

Parameter	Symbol	Conditions	Min	Typ.	Max	Unit
Feedback Current	I_{VFB}				±30	nA
Regulated Feedback Voltage	V_{FB}	$T_A=25^\circ\text{C}$	0.588	0.600	0.612	V
Reference Voltage Line Regulation	ΔV_{FB}	$V_{IN}=2.5V$ to 5.5V			0.4	%/V
Output Voltage Accuracy	$\Delta V_{OUT}\%$		-3		+3	%
Output Over-Voltage Lockout	ΔV_{OVL}	$\Delta V_{OVL} = V_{OVL} - V_{FB}$ (Adj.)	20	50	80	mV
		$\Delta V_{OVL} = V_{OVL} - V_{OUT}$ (Fixed)	2.5	7.8	13	%
Output Voltage Line Regulation	ΔV_{OUT}	$V_{IN}=2.5V$ to 5.5V			0.4	%/V
Peak Inductor Current	I_{PK}	$V_{IN}=3V$, $V_{FB}=0.5V$ or $V_{OUT}=90\%$, Duty cycle <35%		1.0		A
Output Voltage Load Regulation	$V_{LOADREG}$			0.5		%
Quiescent Current (Note 2)	I_Q	$V_{FB}=0.5V$ or $V_{OUT}=90\%$		200	340	µA
Shutdown Current	$I_{SHUTDOWN}$	$V_{EN}=0V$, $V_{IN}=4.2V$		0.1	1	µA
Oscillator Frequency	f_{osc}	$V_{FB}=0.6V$ or $V_{OUT}=100\%$	1.2	1.5	1.8	MHz
		$V_{FB}=0V$ or $V_{OUT}=0V$		290		kHz
$R_{DS(ON)}$ of PMOS	R_{PFET}	$I_{SW}=100mA$		0.45	0.55	Ω
$R_{DS(ON)}$ of NMOS	R_{NFET}	$I_{SW}=100mA$		0.40	0.50	Ω
SW Leakage	I_{LSW}	$V_{EN}=0V$, $V_{SW}=0V$ or 5V, $V_{IN}=5V$			±1	µA
Enable Threshold	V_{EN}				1.2	V
Shutdown Threshold			0.4			V
EN Leakage Current	I_{EN}				±1	µA

Note 1: The Switch Current Limit is related to the Duty Cycle. Please refer to figure 15 for details.

Note 2: Dynamic quiescent current is higher due to the gate charge being delivered at the switching frequency.

Typical Characteristics

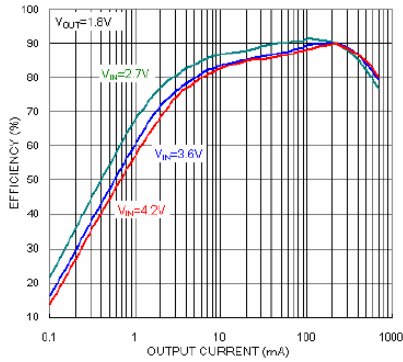

Fig. 2: Efficiency vs Output Current (mA)

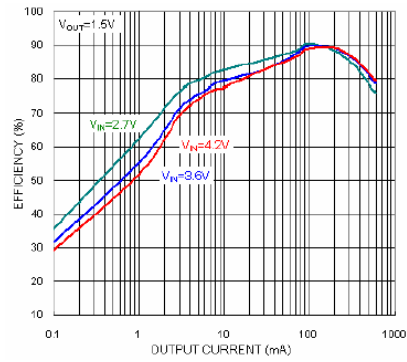

Fig. 3: Efficiency vs Output Current (mA)

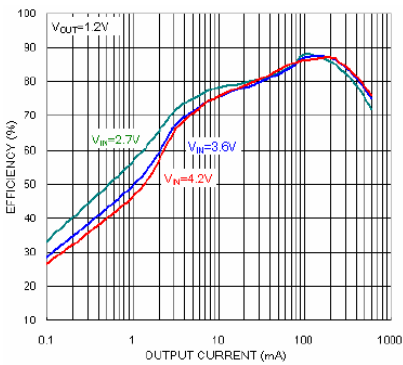

Fig. 4: Efficiency vs Output Current (mA)

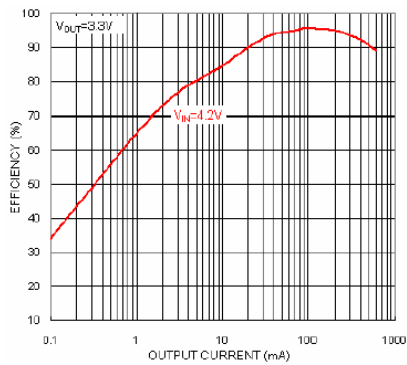

Fig. 5: Efficiency vs Output Current (mA)

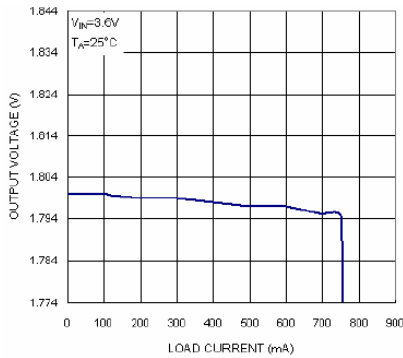

Fig. 6: Output Voltage vs Load Current

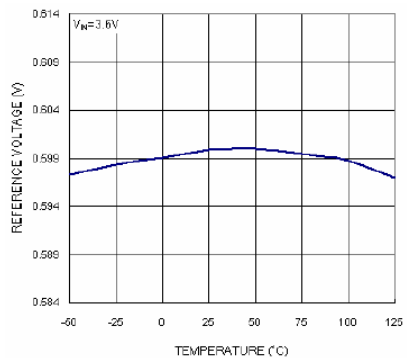

Fig. 7: Reference Voltage vs Temperature

ELECTRICAL CHARACTERISTICS

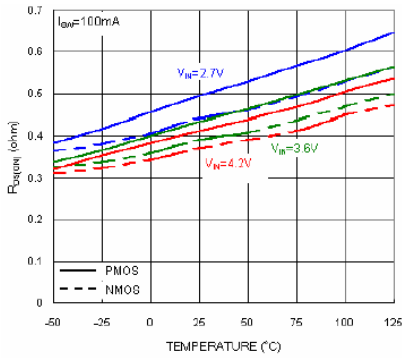

Fig. 8: $R_{DS(ON)}$ vs Temperature

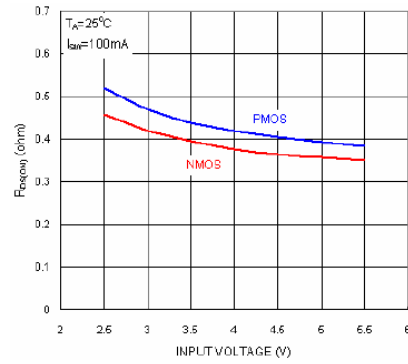

Fig. 9: $R_{DS(ON)}$ vs Input Voltage

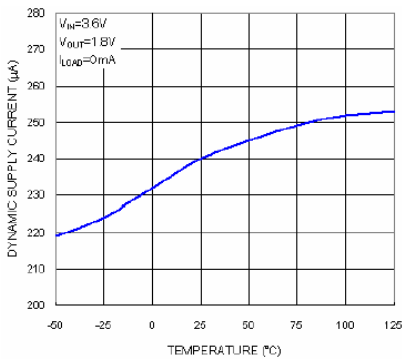

Fig. 10: Dynamic Supply Current vs Temperature

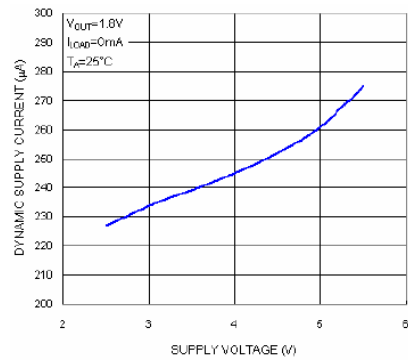

Fig. 11: Dynamic Supply Current vs Supply Voltage

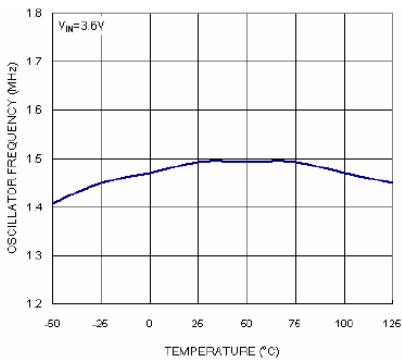

Fig. 12: Oscillator Frequency vs Temperature

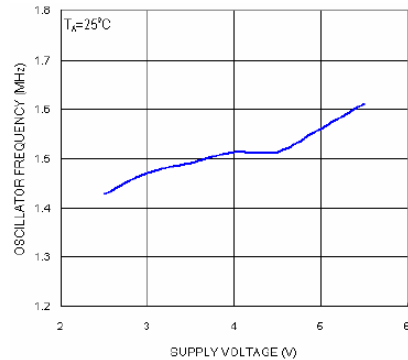

Fig. 13: Oscillator Frequency vs Supply Voltage

ELECTRICAL CHARACTERISTICS

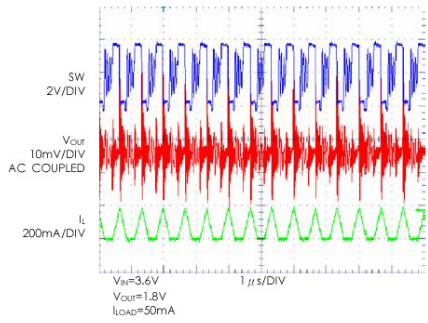

Fig. 14: Discontinuous Operation

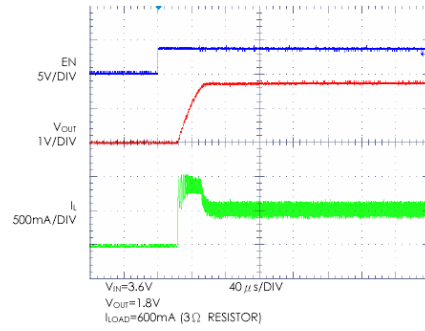

Fig. 15: Start-up from Shutdown

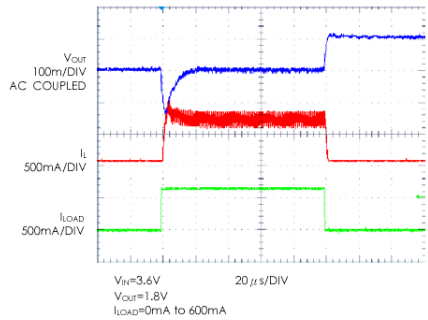

Fig. 16: Load Step

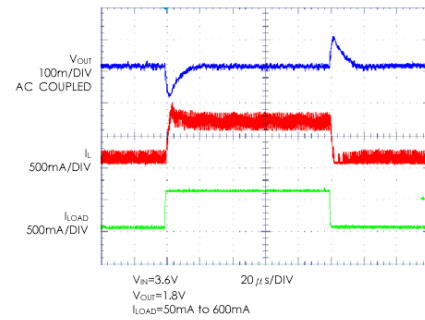

Fig. 17: Load Step

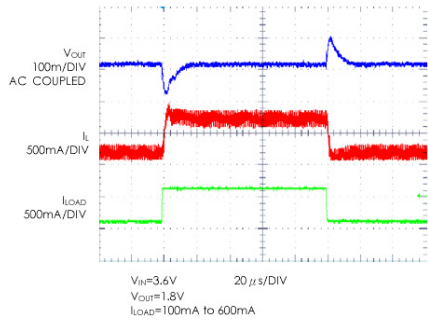

Fig. 17: Load Step

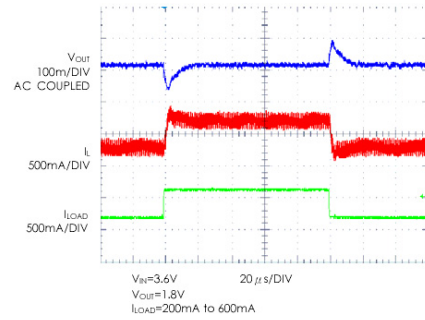

Fig. 18: Load Step

Detailed Description

Applications

The typical application circuit of the adjustable output voltage option and the fixed output voltage option are shown below.

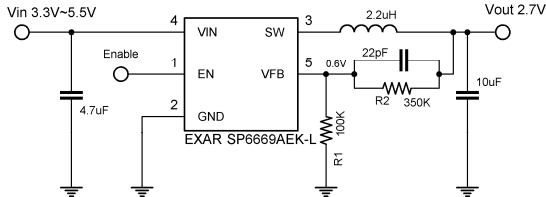

Fig. 18: Adjustable Output Voltage Version Typical Application Circuit

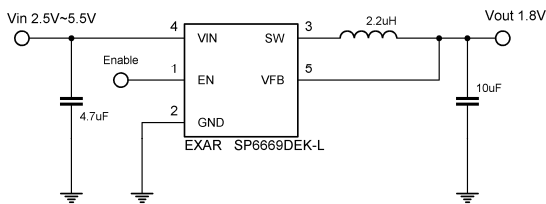

Fig. 19: Fixed Output Voltage Version Typical Application Circuit

Inductor Selection

Inductor ripple current and core saturation are two factors considered to select the inductor value.

$$\text{Eq. 1: } \Delta I_L = \frac{1}{f \cdot L} V_{OUT} \left(1 - \frac{V_{OUT}}{V_{IN}} \right)$$

Equation 1 shows the inductor ripple current as a function of the frequency, inductance, V_{IN} and V_{OUT} . It is recommended to set the ripple current to 40% of the maximum load current. A low ESR inductor is preferred.

C_{IN} and C_{OUT} Selection

A low ESR input capacitor can prevent large voltage transients at V_{IN} . The RMS current rating of the input capacitor is required to be larger than I_{RMS} calculated by:

$$\text{Eq. 2: } I_{RMS} \cong I_{OMAX} \frac{\sqrt{V_{OUT}(V_{IN} - V_{OUT})}}{V_{IN}}$$

The ESR rating of the capacitor is an important parameter to select C_{OUT} . The output ripple V_{OUT} is determined by:

$$\text{Eq. 3: } \Delta V_{OUT} \cong \Delta I_L \left(ESR + \frac{1}{8 \cdot f \cdot C_{OUT}} \right)$$

Higher values, lower cost ceramic capacitors are now available in smaller sizes. These capacitors have high ripple currents, high voltage ratings and low ESR that makes them ideal for switching regulator applications. As C_{OUT} does not affect the internal control loop stability, its value can be optimized to balance very low output ripple and circuit size. It is recommended to use an X5R or X7R rated capacitors which have the best temperature and voltage characteristics of all the ceramics for a given value and size.

Output Voltage – Adjustable Version

The adjustable output voltage version is determined by:

$$\text{Eq. 4: } V_{OUT} = 0.6V \cdot \left(1 + \frac{R_2}{R_1} \right)$$

Thermal Considerations

Although the SP6669 has an on board over temperature circuitry, the total power dissipation it can support is based on the package thermal capabilities. The formula to ensure safe operation is given in note 1.

PCB Layout

The following PCB layout guidelines should be taken into account to ensure proper operation and performance of the SP6669:

- 1- The GND, SW and V_{IN} traces should be kept short, direct and wide.
- 2- V_{FB} pin must be connected directly to the feedback resistors. The resistor divider network must be connected in parallel to the C_{OUT} capacitor.
- 3- The input capacitor C_{IN} must be kept as close as possible to the V_{IN} pin.

4- The SW and VFB nodes should be kept as separate as possible to minimize possible effects from the high frequency and voltage swings of the SW node.

5- The ground plates of C_{IN} and C_{OUT} should be kept as close as possible.

Output Voltage Ripple for V_{IN} close to V_{OUT}

When the input voltage V_{IN} is close to the output voltage V_{OUT}, the SP6669 transitions smoothly from the switching PWM converter mode into a LDO mode. The following diagram shows the output voltage ripple versus the input voltage for a 3.3V output setting and a 200mA current load.

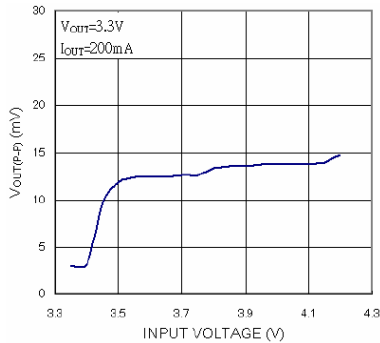

Fig.20: V_{OUT} Ripple Voltage for V_{IN} decreasing close to V_{OUT}

Design Example

In a single Lithium-Ion battery powered application, the V_{IN} range is about 2.7V to 4.2V. The desired output voltage is 1.8V.

The inductor value needed can be calculated using the following equation

$$L = \frac{1}{f \cdot \Delta I_L} V_{OUT} \left(1 - \frac{V_{OUT}}{V_{IN}} \right)$$

Substituting V_{OUT}=1.8V, V_{IN}=4.2V, ΔI_L=240mA and f=1.5MHz gives

$$L = 2.86 \mu H$$

A 2.2μH inductor can be chosen with this application. An inductor of greater value with less equivalent series resistance would provide better efficiency. The C_{IN} capacitor requires an RMS current rating of at least I_{LOAD(MAX)}/2 and low ESR. In most cases, a ceramic capacitor will satisfy this requirement.

SOT23-5L

Unit: mm

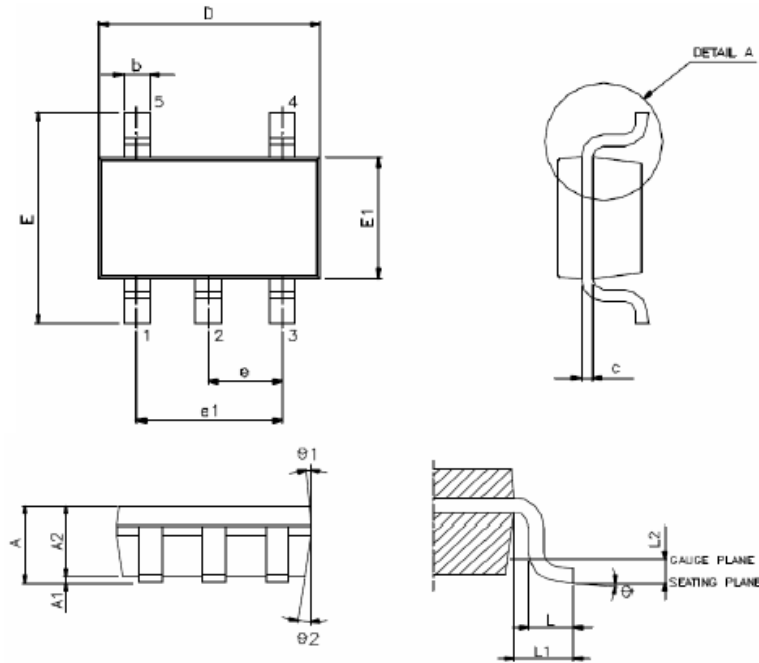

DETAIL A

VARIATION(ALL DIMENSIONS SHOWN IN MM)

SYMBOL	MIN.	NOM.	MAX.
A	1.05	1.20	1.35
A1	0.05	0.10	0.15
A2	1.00	1.10	1.20
b	0.30	—	0.50
c	0.08	—	0.20
D	2.80	2.90	3.00
E	2.60	2.80	3.00
E1	1.50	1.60	1.70
e	0.95 BSC.		
e1	1.90 BSC.		
L	0.30	0.45	0.55
L1	0.80 REF.		
L2	0.25 BSC.		
ϕ	0°	5°	10°
$\phi1$	3°	5°	7°
$\phi2$	6°	8°	10°

NOTE : 1. JEDEC OUTLINE : MO-178 AA

ORDERING INFORMATION

Adjustable Output Voltage Version

Part Number	Voltage Option	Operating Temperature Range	Package	Marking	Packing Quantity
SP6669AEK-L/TRR3	Adjustable	-40°C to +85°C	SOT23-5	QBWW	3,000/T&R

"WW" = Work Week

Fixed Output Voltage Version

Part Number	Voltage Option	Operating Temperature Range	Package	Marking	Packing Quantity
SP6669BEK-L/TRR3	1.2V	-40°C to +85°C	SOT23-5	RBWW	3,000/T&R
SP6669CEK-L/TRR3	1.5V	-40°C to +85°C	SOT23-5	SBWW	3,000/T&R
SP6669DEK-L/TRR3	1.8V	-40°C to +85°C	SOT23-5	TBWW	3,000/T&R

"WW" = Work Week

Note that the SP6669 series is packaged in Tape and Reel with a reverse part orientation as per the following diagram

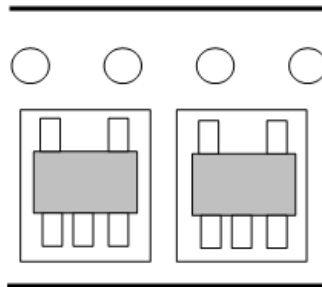

Notice

EXAR Corporation reserves the right to make changes to the products contained in this publication in order to improve design, performance or reliability. EXAR Corporation assumes no responsibility for the use of any circuits described herein, conveys no license under any patent or other right, and makes no representation that the circuits are free of patent infringement. Charts and schedules contained here in are only for illustration purposes and may vary depending upon a user's specific application. While the information in this publication has been carefully checked; no responsibility, however, is assumed for inaccuracies.

EXAR Corporation does not recommend the use of any of its products in life support applications where the failure or malfunction of the product can reasonably be expected to cause failure of the life support system or to significantly affect its safety or effectiveness. Products are not authorized for use in such applications unless EXAR Corporation receives, in writing, assurances to its satisfaction that: (a) the risk of injury or damage has been minimized; (b) the user assumes all such risks; (c) potential liability of EXAR Corporation is adequately protected under the circumstances.

Reproduction, in part or whole, without the prior written consent of EXAR Corporation is prohibited.



Exar Corporation Headquarters and Sales Offices

48720 Kato Road
Fremont, CA 94538 – USA
Tel.: +1 (510) 668-7000
Fax: +1 (510) 668-7030
www.exar.com