

## 250 mA Low Quiescent Current LDO Regulator

### Features

- 2.0  $\mu$ A Quiescent Current (typical)
- Input Operating Voltage Range: 2.7V to 13.2V
- 250 mA Output Current for Output Voltages  $\geq$  2.5V
- 200 mA Output Current for Output Voltages  $<$  2.5V
- Low Dropout (LDO) voltage
  - 625 mV typical @ 250 mA ( $V_{OUT} = 2.8V$ )
- 0.4% Typical Output Voltage Tolerance
- Standard Output Voltage Options:
  - 1.2V, 1.5V, 1.8V, 2.5V, 2.8V, 3.0V, 3.3V, 4.0V, 5.0V
- Output voltage range 1.2V to 5.5V in 0.1V Increments (50 mV increments available upon request)
- Stable with 1.0  $\mu$ F to 22  $\mu$ F Output Capacitor
- Short-Circuit Protection
- Overtemperature Protection

### Applications

- Battery-powered Devices
- Battery-powered Alarm Circuits
- Smoke Detectors
- CO<sup>2</sup> Detectors
- Pagers and Cellular Phones
- Smart Battery Packs
- Low Quiescent Current Voltage Reference
- PDAs
- Digital Cameras
- Microcontroller Power
- Solar-Powered Instruments
- Consumer Products
- Battery Powered Data Loggers

### Related Literature

- AN765, "Using Microchip's Micropower LDOs", DS00765, Microchip Technology Inc., 2002
- AN766, "Pin-Compatible CMOS Upgrades to BiPolar LDOs", DS00766, Microchip Technology Inc., 2002
- AN792, "A Method to Determine How Much Power a SOT23 Can Dissipate in an Application", DS00792, Microchip Technology Inc., 2001

### Description

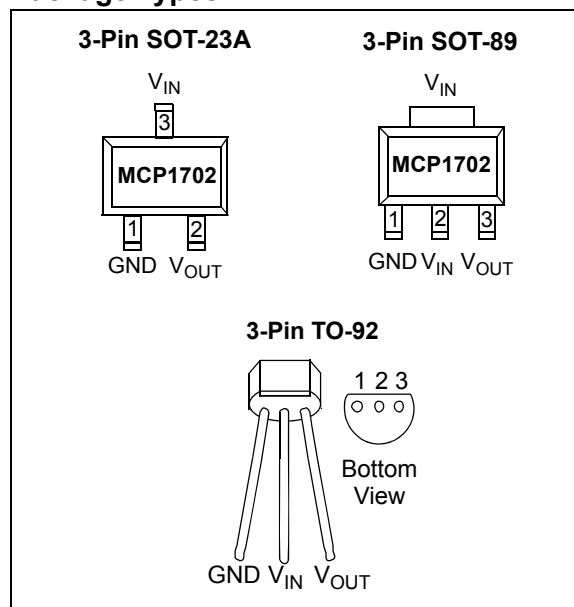
The MCP1702 is a family of CMOS low dropout (LDO) voltage regulators that can deliver up to 250 mA of current while consuming only 2.0  $\mu$ A of quiescent current (typical). The input operating range is specified from 2.7V to 13.2V, making it an ideal choice for two to six primary cell battery-powered applications, 9V alkaline and one or two cell Li-Ion-powered applications.

The MCP1702 is capable of delivering 250 mA with only 625 mV (typical) of input to output voltage differential ( $V_{OUT} = 2.8V$ ). The output voltage tolerance of the MCP1702 is typically  $\pm 0.4\%$  at  $+25^{\circ}C$  and  $\pm 3\%$  maximum over the operating junction temperature range of  $-40^{\circ}C$  to  $+125^{\circ}C$ . Line regulation is  $\pm 0.1\%$  typical at  $+25^{\circ}C$ .

Output voltages available for the MCP1702 range from 1.2V to 5.0V. The LDO output is stable when using only 1  $\mu$ F of output capacitance. Ceramic, tantalum or aluminum electrolytic capacitors can all be used for input and output. Overcurrent limit and overtemperature shutdown provide a robust solution for any application.

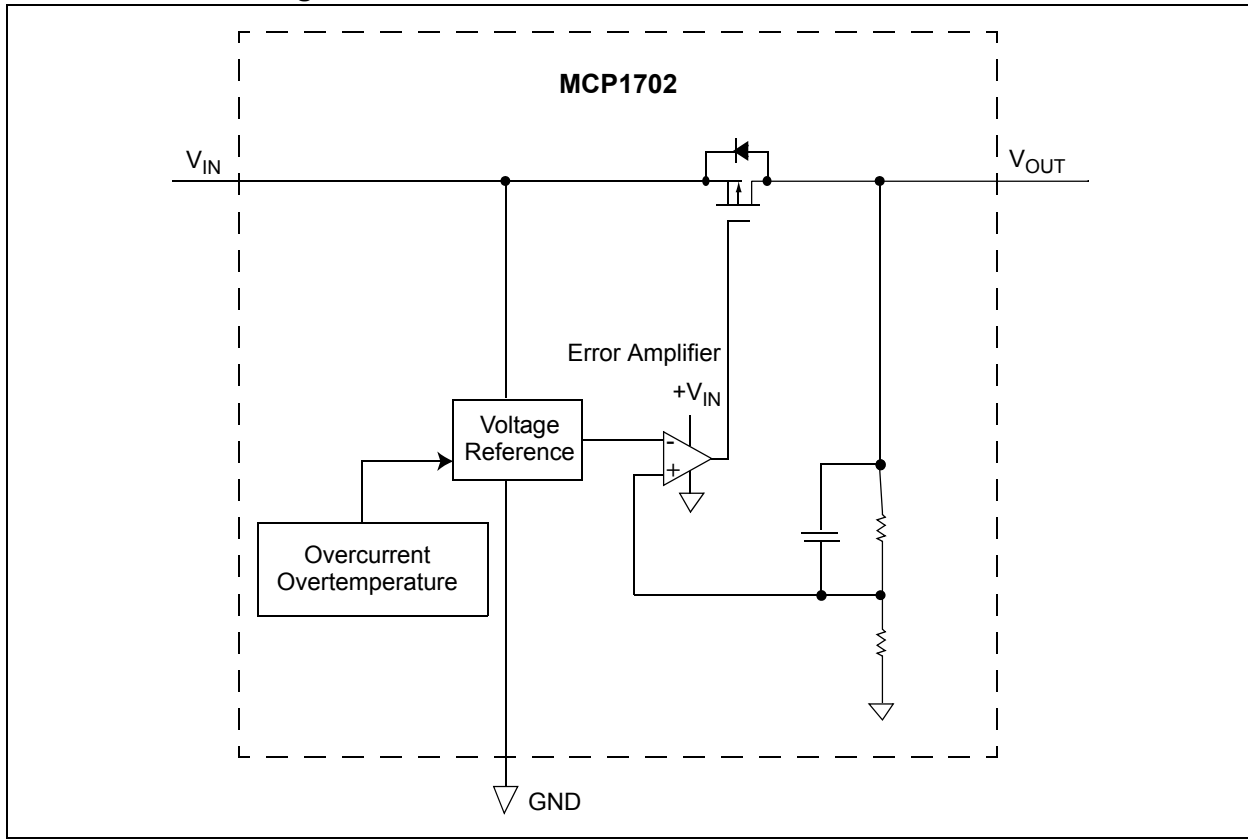
Package options include the SOT-23A, SOT89-3, and TO-92.

### Package Types

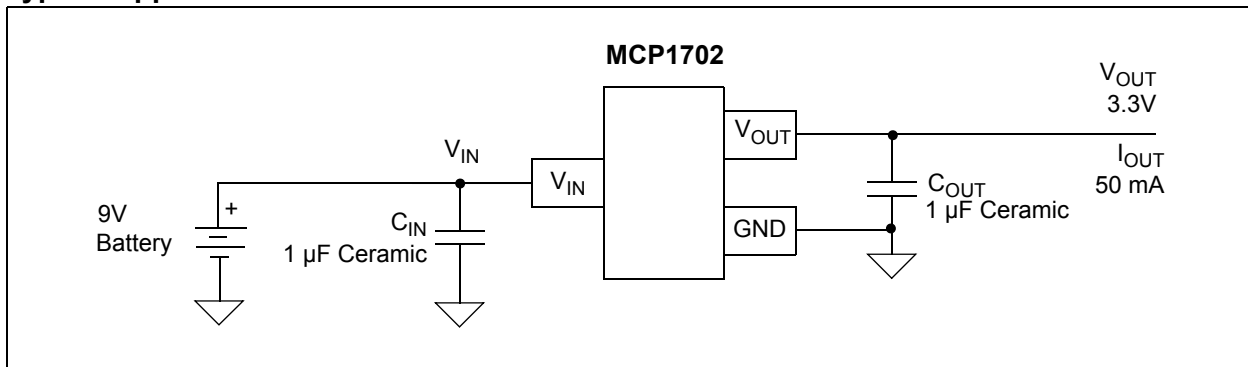


# MCP1702

## Functional Block Diagrams



## Typical Application Circuits



## 1.0 ELECTRICAL CHARACTERISTICS

### Absolute Maximum Ratings †

V <sub>DD</sub> .....	+14.5V
All inputs and outputs w.r.t. ....	(V <sub>SS</sub> -0.3V) to (V <sub>IN</sub> +0.3V)
Peak Output Current .....	500 mA
Storage temperature .....	-65°C to +150°C
Maximum Junction Temperature .....	150°C
Operating Junction Temperature.....	-40°C to +125°C
ESD protection on all pins (HBM;MM).....	≥ 4 kV; ≥ 400V

† **Notice:** Stresses above those listed under “Maximum Ratings” may cause permanent damage to the device. This is a stress rating only and functional operation of the device at those or any other conditions above those indicated in the operational listings of this specification is not implied. Exposure to maximum rating conditions for extended periods may affect device reliability.

### DC CHARACTERISTICS

**Electrical Specifications:** Unless otherwise specified, all limits are established for V<sub>IN</sub> = V<sub>OUT(MAX)</sub> + V<sub>DROPOUT(MAX)</sub>, **Note 1**, I<sub>LOAD</sub> = 100 μA, C<sub>OUT</sub> = 1 μF (X7R), C<sub>IN</sub> = 1 μF (X7R), T<sub>A</sub> = +25°C.  
**Boldface** type applies for junction temperatures, T<sub>J</sub> of -40°C to +125°C. (**Note 7**)

Parameters	Sym	Min	Typ	Max	Units	Conditions
<b>Input / Output Characteristics</b>						
Input Operating Voltage	V <sub>IN</sub>	<b>2.7</b>	—	<b>13.2</b>	V	<b>Note 1</b>
Input Quiescent Current	I <sub>q</sub>	—	2.0	<b>5</b>	μA	I <sub>L</sub> = 0 mA
Maximum Output Current	I <sub>OUT_mA</sub>	<b>250</b>	—	—	mA	For V <sub>R</sub> ≥ 2.5V
		<b>50</b>	100	—	mA	For V <sub>R</sub> < 2.5V, V <sub>IN</sub> ≥ 2.7V
		<b>100</b>	130	—	mA	For V <sub>R</sub> < 2.5V, V <sub>IN</sub> ≥ 2.95V
		<b>150</b>	200	—	mA	For V <sub>R</sub> < 2.5V, V <sub>IN</sub> ≥ 3.2V
		<b>200</b>	250	—	mA	For V <sub>R</sub> < 2.5V, V <sub>IN</sub> ≥ 3.45V
Output Short Circuit Current	I <sub>OUT_SC</sub>	—	400	—	mA	V <sub>IN</sub> = V <sub>IN(MIN)</sub> ( <b>Note 1</b> ), V <sub>OUT</sub> = GND, Current (average current) measured 10 ms after short is applied.
Output Voltage Regulation	V <sub>OUT</sub>	<b>V<sub>R</sub>-3.0%</b> <b>V<sub>R</sub>-2.0%</b>	V <sub>R</sub> ±0.4 %	<b>V<sub>R</sub>+3.0%</b> <b>V<sub>R</sub>+2.0%</b>	V	<b>Note 2</b>
V <sub>OUT</sub> Temperature Coefficient	TCV <sub>OUT</sub>	—	50	<b>150</b>	ppm/°C	<b>Note 3</b>
Line Regulation	$\frac{\Delta V_{OUT}}{V_{OUT} \times \Delta V_{IN}}$	<b>-0.3</b>	±0.1	<b>+0.3</b>	%/V	(V <sub>OUT(MAX)</sub> + V <sub>DROPOUT(MAX)</sub> ) ≤ V <sub>IN</sub> ≤ 13.2V, ( <b>Note 1</b> )
Load Regulation	$\frac{\Delta V_{OUT}}{V_{OUT}}$	<b>-2.5</b>	±1.0	<b>+2.5</b>	%	I <sub>L</sub> = 1.0 mA to 250 mA for V <sub>R</sub> ≥ 2.5V I <sub>L</sub> = 1.0 mA to <b>200</b> mA for V <sub>R</sub> < 2.5V, V <sub>IN</sub> = 3.45V <b>Note 4</b>

- Note 1:** The minimum V<sub>IN</sub> must meet two conditions: V<sub>IN</sub> ≥ 2.7V and V<sub>IN</sub> ≥ V<sub>OUT(MAX)</sub> + V<sub>DROPOUT(MAX)</sub>.
- 2:** V<sub>R</sub> is the nominal regulator output voltage. For example: V<sub>R</sub> = 1.2V, 1.5V, 1.8V, 2.5V, 2.8V, 3.0V, 3.3V, 4.0V, or 5.0V. The input voltage V<sub>IN</sub> = V<sub>OUT(MAX)</sub> + V<sub>DROPOUT(MAX)</sub> or V<sub>IN</sub> = 2.7V (whichever is greater); I<sub>OUT</sub> = 100 μA.
- 3:** TCV<sub>OUT</sub> = (V<sub>OUT-HIGH</sub> - V<sub>OUT-LOW</sub>) \* 10<sup>6</sup> / (V<sub>R</sub> \* ΔTemperature), V<sub>OUT-HIGH</sub> = highest voltage measured over the temperature range. V<sub>OUT-LOW</sub> = lowest voltage measured over the temperature range.
- 4:** Load regulation is measured at a constant junction temperature using low duty cycle pulse testing. Changes in output voltage due to heating effects are determined using thermal regulation specification TCV<sub>OUT</sub>.
- 5:** Dropout voltage is defined as the input to output differential at which the output voltage drops 2% below its measured value with an applied input voltage of V<sub>OUT(MAX)</sub> + V<sub>DROPOUT(MAX)</sub> or 2.7V, whichever is greater.
- 6:** The maximum allowable power dissipation is a function of ambient temperature, the maximum allowable junction temperature and the thermal resistance from junction to air (i.e., T<sub>A</sub>, T<sub>J</sub>, θ<sub>JA</sub>). Exceeding the maximum allowable power dissipation will cause the device operating junction temperature to exceed the maximum 150°C rating. Sustained junction temperatures above 150°C can impact the device reliability.
- 7:** The junction temperature is approximated by soaking the device under test at an ambient temperature equal to the desired Junction temperature. The test time is small enough such that the rise in the Junction temperature over the ambient temperature is not significant.

# MCP1702

## DC CHARACTERISTICS (CONTINUED)

**Electrical Specifications:** Unless otherwise specified, all limits are established for  $V_{IN} = V_{OUT(MAX)} + V_{DROPOUT(MAX)}$ , **Note 1**,  $I_{LOAD} = 100 \mu A$ ,  $C_{OUT} = 1 \mu F$  (X7R),  $C_{IN} = 1 \mu F$  (X7R),  $T_A = +25^\circ C$ .  
**Boldface type applies for junction temperatures,  $T_J$  of  $-40^\circ C$  to  $+125^\circ C$ . (Note 7)**

Parameters	Sym	Min	Typ	Max	Units	Conditions
Dropout Voltage (Note 1, Note 5)	$V_{DROPOUT}$	—	330	<b>650</b>	mV	$I_L = 250 \text{ mA}$ , $V_R = 5.0V$
		—	525	<b>725</b>	mV	$I_L = 250 \text{ mA}$ , $3.3V \leq V_R < 5.0V$
		—	625	<b>975</b>	mV	$I_L = 250 \text{ mA}$ , $2.8V \leq V_R < 3.3V$
		—	750	<b>1100</b>	mV	$I_L = 250 \text{ mA}$ , $2.5V \leq V_R < 2.8V$
		—	—	—	mV	$V_R < 2.5V$ , See Maximum Output Current Parameter
Output Delay Time	$T_{DELAY}$	—	1000	—	$\mu s$	$V_{IN} = 0V$ to $6V$ , $V_{OUT} = 90\% V_R$ $R_L = 50\Omega$ resistive
Output Noise	$e_N$	—	8	—	$\mu V/(Hz)^{1/2}$	$I_L = 50 \text{ mA}$ , $f = 1 \text{ kHz}$ , $C_{OUT} = 1 \mu F$
Power Supply Ripple Rejection Ratio	PSRR	—	44	—	dB	$f = 100 \text{ Hz}$ , $C_{OUT} = 1 \mu F$ , $I_L = 50 \text{ mA}$ , $V_{INAC} = 100 \text{ mV pk-pk}$ , $C_{IN} = 0 \mu F$ , $V_R = 1.2V$
Thermal Shutdown Protection	$T_{SD}$	—	150	—	$^\circ C$	

- Note 1:** The minimum  $V_{IN}$  must meet two conditions:  $V_{IN} \geq 2.7V$  and  $V_{IN} \geq V_{OUT(MAX)} + V_{DROPOUT(MAX)}$ .
- 2:**  $V_R$  is the nominal regulator output voltage. For example:  $V_R = 1.2V, 1.5V, 1.8V, 2.5V, 2.8V, 3.0V, 3.3V, 4.0V$ , or  $5.0V$ . The input voltage  $V_{IN} = V_{OUT(MAX)} + V_{DROPOUT(MAX)}$  or  $V_{IN} = 2.7V$  (whichever is greater);  $I_{OUT} = 100 \mu A$ .
- 3:**  $TCV_{OUT} = (V_{OUT-HIGH} - V_{OUT-LOW}) * 10^6 / (V_R * \Delta \text{Temperature})$ ,  $V_{OUT-HIGH}$  = highest voltage measured over the temperature range.  $V_{OUT-LOW}$  = lowest voltage measured over the temperature range.
- 4:** Load regulation is measured at a constant junction temperature using low duty cycle pulse testing. Changes in output voltage due to heating effects are determined using thermal regulation specification  $TCV_{OUT}$ .
- 5:** Dropout voltage is defined as the input to output differential at which the output voltage drops 2% below its measured value with an applied input voltage of  $V_{OUT(MAX)} + V_{DROPOUT(MAX)}$  or  $2.7V$ , whichever is greater.
- 6:** The maximum allowable power dissipation is a function of ambient temperature, the maximum allowable junction temperature and the thermal resistance from junction to air (i.e.,  $T_A, T_J, \theta_{JA}$ ). Exceeding the maximum allowable power dissipation will cause the device operating junction temperature to exceed the maximum  $150^\circ C$  rating. Sustained junction temperatures above  $150^\circ C$  can impact the device reliability.
- 7:** The junction temperature is approximated by soaking the device under test at an ambient temperature equal to the desired Junction temperature. The test time is small enough such that the rise in the Junction temperature over the ambient temperature is not significant.

## TEMPERATURE SPECIFICATIONS

**Electrical Characteristics:** Unless otherwise specified, all limits are established for  $V_{IN} = V_R + 1V$  or  $2.7V$ , whichever is greater,  $I_{LOAD} = 100 \mu A$ ,  $C_{OUT} = 1 \mu F$  (X7R),  $C_{IN} = 1 \mu F$  (X7R),  $T_A = +25^\circ C$ .  
**Boldface type applies for junction temperatures,  $T_J$  (Note 1) of  $-40^\circ C$  to  $+125^\circ C$ .**

Parameters	Sym	Min	Typ	Max	Units	Conditions
<b>Temperature Ranges</b>						
Specified Temperature Range	$T_J$	-40		+125	$^\circ C$	
Operating Temperature Range	$T_J$	-40		+125	$^\circ C$	
Storage Temperature Range	$T_A$	-65		+150	$^\circ C$	
<b>Thermal Package Resistance</b>						
Thermal Resistance, SOT-23A	$\theta_{JA}$	—	336	—	$^\circ C/W$	EIA/JEDEC JESD51-7 FR-4 0.063 4-Layer Board
Thermal Resistance, SOT89	$\theta_{JA}$	—	52	—	$^\circ C/W$	EIA/JEDEC JESD51-7 FR-4 0.063 4-Layer Board
Thermal Resistance, TO-92	$\theta_{JA}$	—	131.9	—	$^\circ C/W$	

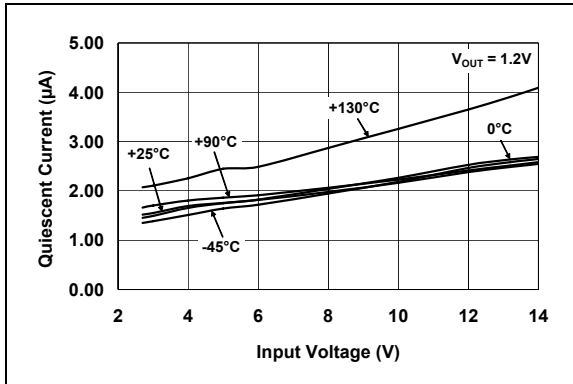
- Note 1:** The maximum allowable power dissipation is a function of ambient temperature, the maximum allowable junction temperature and the thermal resistance from junction to air (i.e.,  $T_A, T_J, \theta_{JA}$ ). Exceeding the maximum allowable power dissipation will cause the device operating junction temperature to exceed the maximum  $150^\circ C$  rating. Sustained junction temperatures above  $150^\circ C$  can impact the device reliability.

## 2.0 TYPICAL PERFORMANCE CURVES

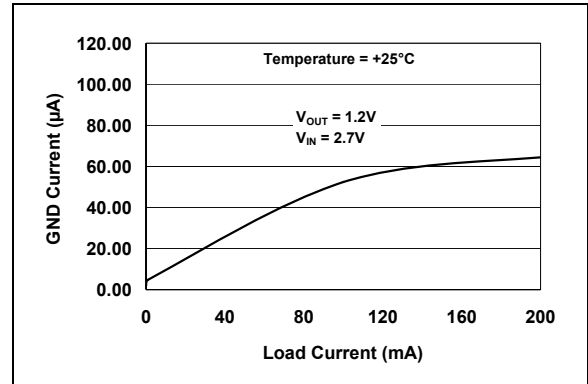
**Note:** The graphs and tables provided following this note are a statistical summary based on a limited number of samples and are provided for informational purposes only. The performance characteristics listed herein are not tested or guaranteed. In some graphs or tables, the data presented may be outside the specified operating range (e.g., outside specified power supply range) and therefore outside the warranted range.

**Note:** Unless otherwise indicated:  $V_R = 2.8V$ ,  $C_{OUT} = 1 \mu F$  Ceramic (X7R),  $C_{IN} = 1 \mu F$  Ceramic (X7R),  $I_L = 100 \mu A$ ,  $T_A = +25^\circ C$ ,  $V_{IN} = V_{OUT(MAX)} + V_{DROPOUT(MAX)}$ .

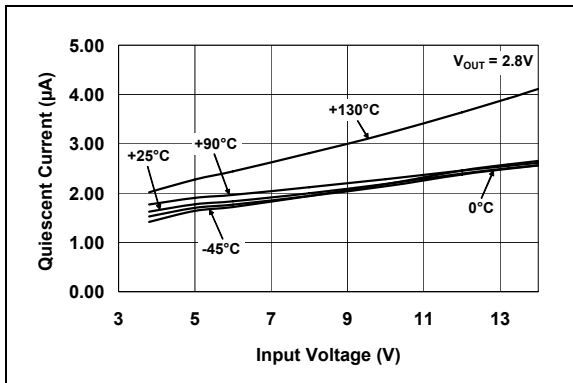
**Note:** Junction Temperature ( $T_J$ ) is approximated by soaking the device under test to an ambient temperature equal to the desired junction temperature. The test time is small enough such that the rise in Junction temperature over the Ambient temperature is not significant.



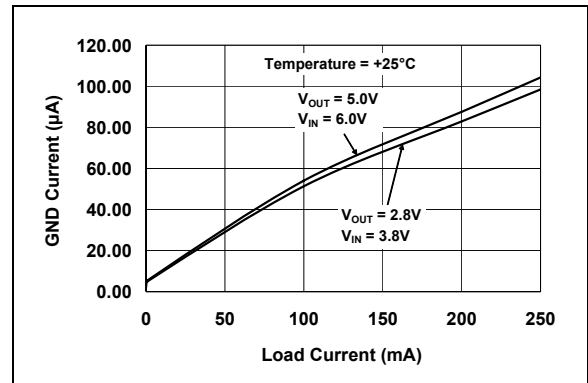
**FIGURE 2-1:** Quiescent Current vs. Input Voltage.



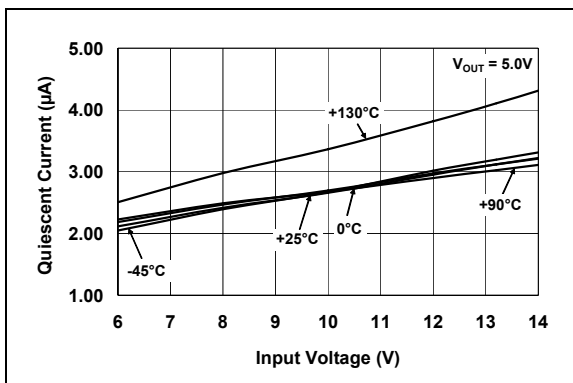
**FIGURE 2-4:** Ground Current vs. Load Current.



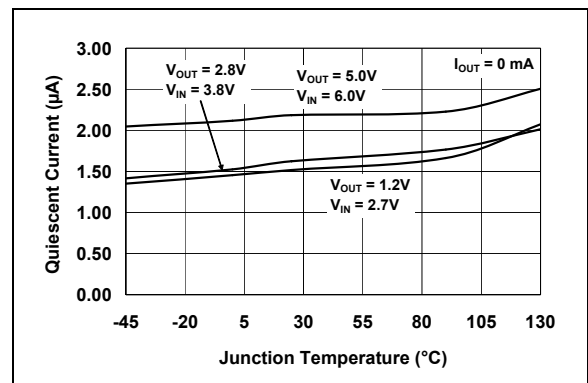
**FIGURE 2-2:** Quiescent Current vs. Input Voltage.



**FIGURE 2-5:** Ground Current vs. Load Current.



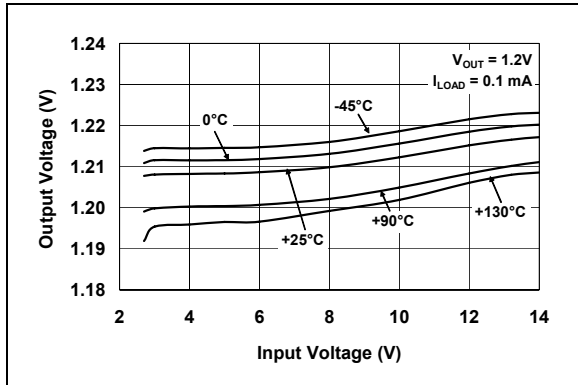
**FIGURE 2-3:** Quiescent Current vs. Input Voltage.



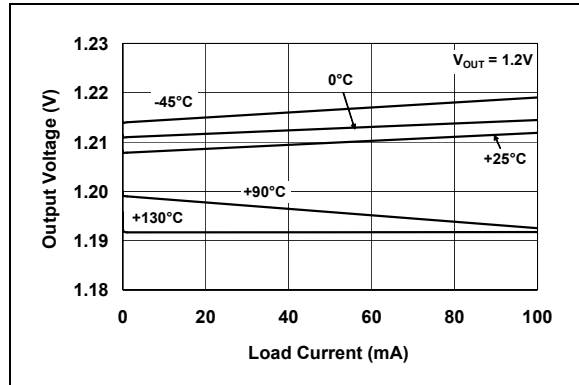
**FIGURE 2-6:** Quiescent Current vs. Junction Temperature.

# MCP1702

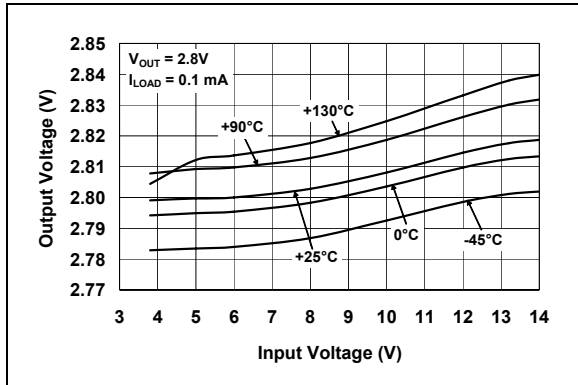
**Note:** Unless otherwise indicated:  $V_R = 2.8V$ ,  $C_{OUT} = 1 \mu F$  Ceramic (X7R),  $C_{IN} = 1 \mu F$  Ceramic (X7R),  $I_L = 100 \mu A$ ,  $T_A = +25^\circ C$ ,  $V_{IN} = V_{OUT(MAX)} + V_{DROPOUT(MAX)}$ .



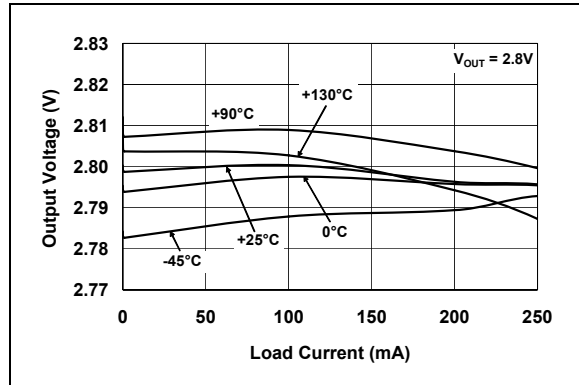
**FIGURE 2-7:** Output Voltage vs. Input Voltage.



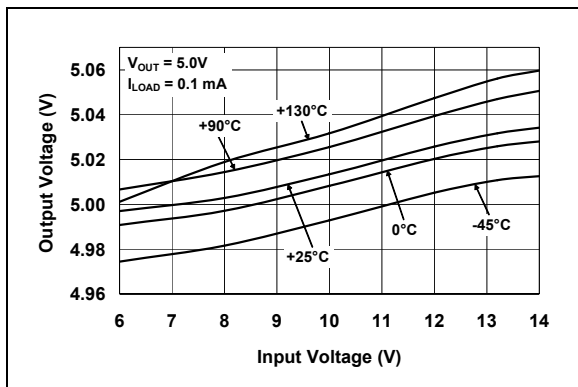
**FIGURE 2-10:** Output Voltage vs. Load Current.



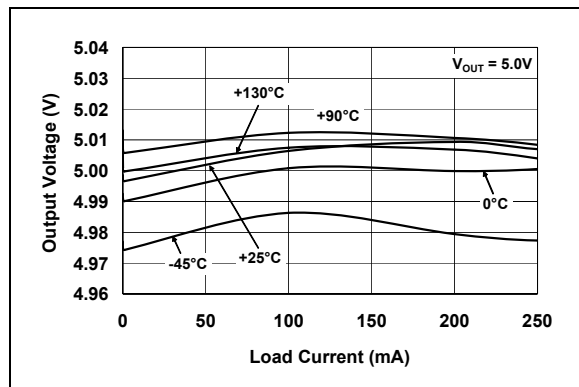
**FIGURE 2-8:** Output Voltage vs. Input Voltage.



**FIGURE 2-11:** Output Voltage vs. Load Current.

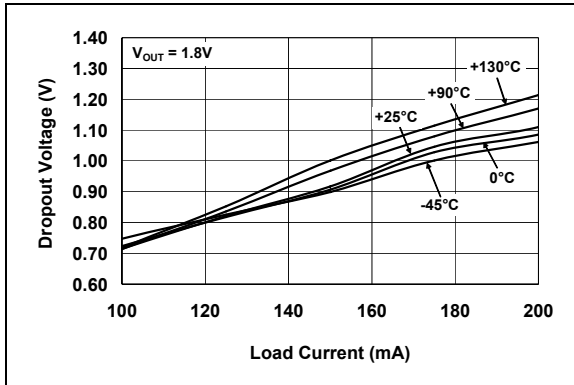


**FIGURE 2-9:** Output Voltage vs. Input Voltage.

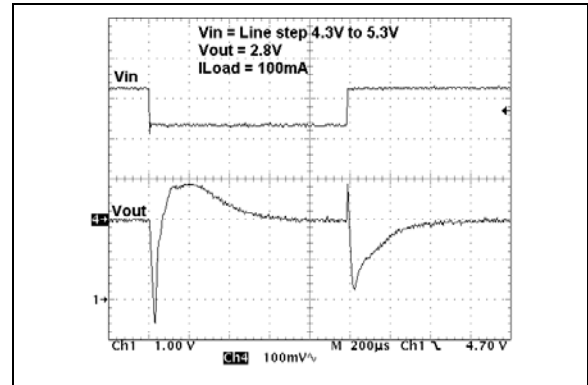


**FIGURE 2-12:** Output Voltage vs. Load Current.

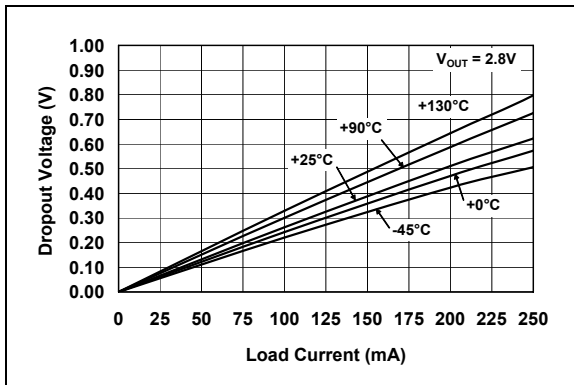
**Note:** Unless otherwise indicated:  $V_R = 2.8V$ ,  $C_{OUT} = 1 \mu F$  Ceramic (X7R),  $C_{IN} = 1 \mu F$  Ceramic (X7R),  $I_L = 100 \mu A$ ,  $T_A = +25^\circ C$ ,  $V_{IN} = V_{OUT(MAX)} + V_{DROPOUT(MAX)}$ .



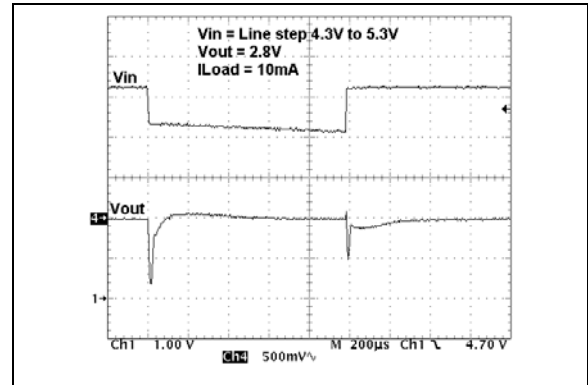
**FIGURE 2-13:** Dropout Voltage vs. Load Current.



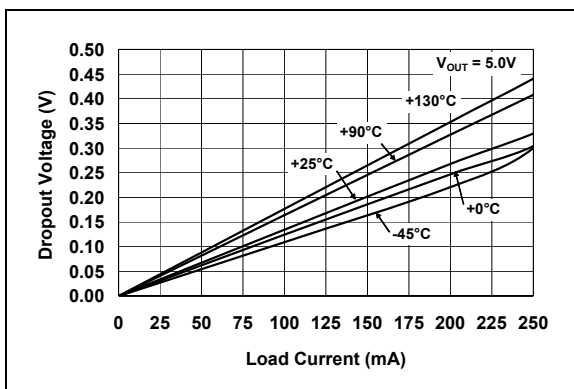
**FIGURE 2-16:** Dynamic Line Response.



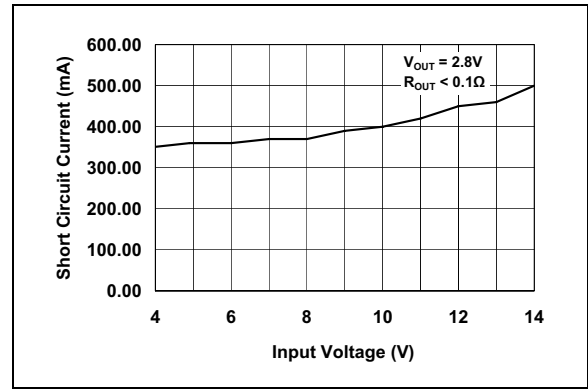
**FIGURE 2-14:** Dropout Voltage vs. Load Current.



**FIGURE 2-17:** Dynamic Line Response.



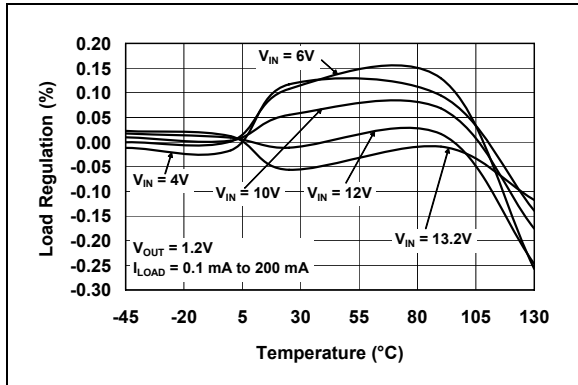
**FIGURE 2-15:** Dropout Voltage vs. Load Current.



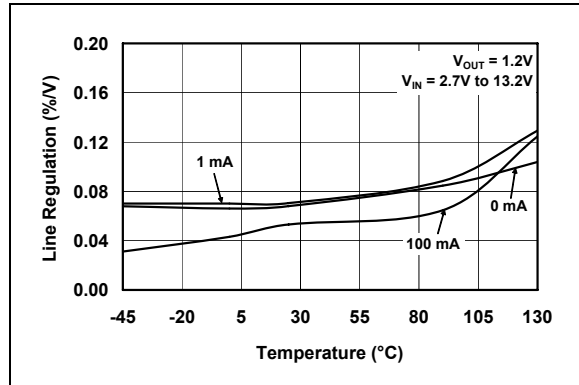
**FIGURE 2-18:** Short Circuit Current vs. Input Voltage.

# MCP1702

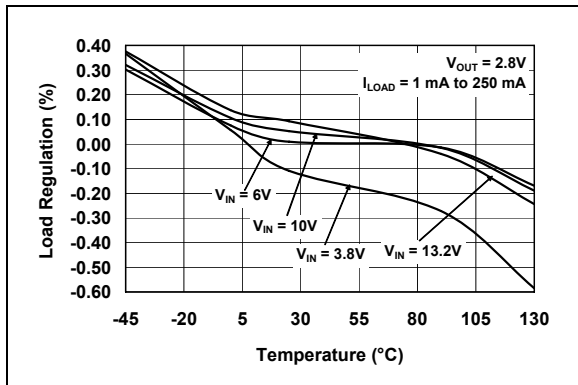
**Note:** Unless otherwise indicated:  $V_R = 2.8V$ ,  $C_{OUT} = 1 \mu F$  Ceramic (X7R),  $C_{IN} = 1 \mu F$  Ceramic (X7R),  $I_L = 100 \mu A$ ,  $T_A = +25^\circ C$ ,  $V_{IN} = V_{OUT(MAX)} + V_{DROPOUT(MAX)}$ .



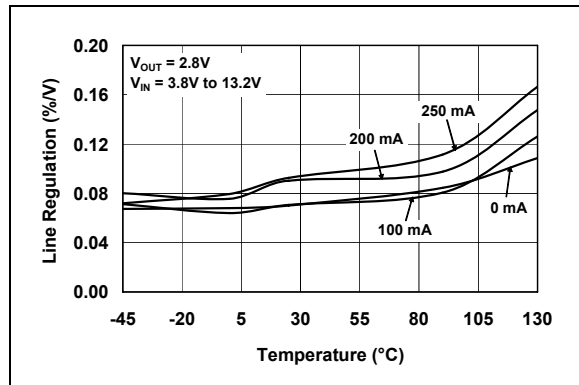
**FIGURE 2-19:** Load Regulation vs. Temperature.



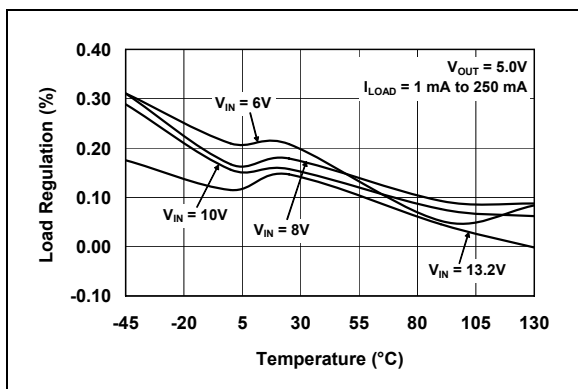
**FIGURE 2-22:** Line Regulation vs. Temperature.



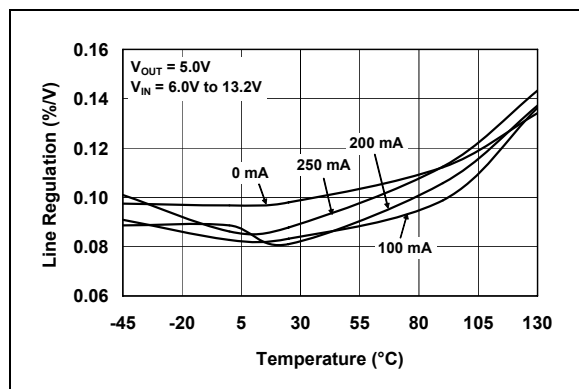
**FIGURE 2-20:** Load Regulation vs. Temperature.



**FIGURE 2-23:** Line Regulation vs. Temperature.



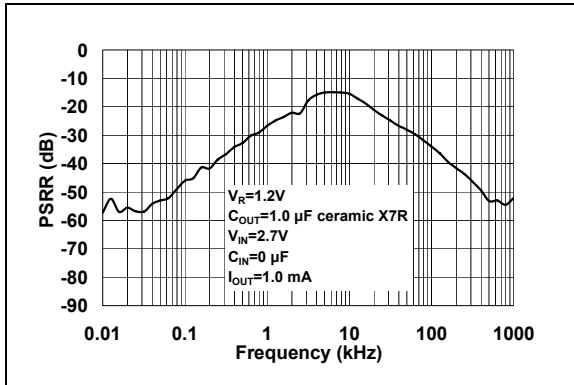
**FIGURE 2-21:** Load Regulation vs. Temperature.



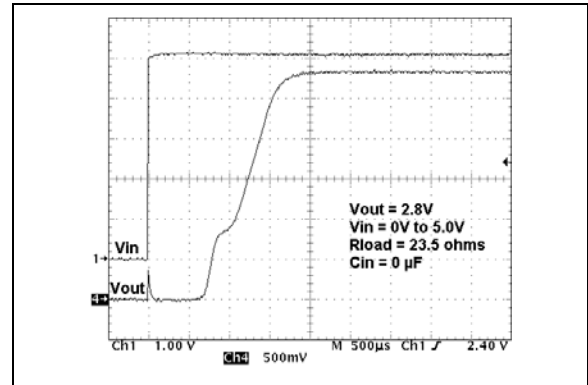
**FIGURE 2-24:** Line Regulation vs. Temperature.



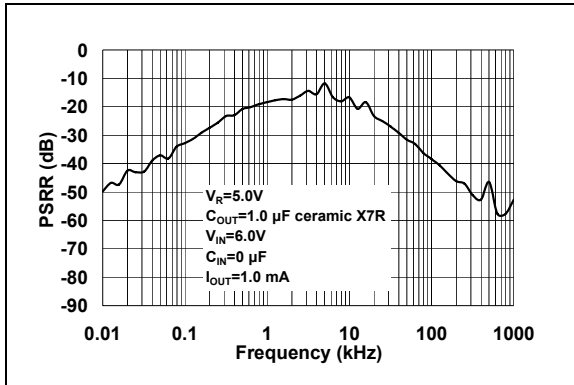
**Note:** Unless otherwise indicated:  $V_R = 2.8V$ ,  $C_{OUT} = 1 \mu F$  Ceramic (X7R),  $C_{IN} = 1 \mu F$  Ceramic (X7R),  $I_L = 100 \mu A$ ,  $T_A = +25^\circ C$ ,  $V_{IN} = V_{OUT(MAX)} + V_{DROPOUT(MAX)}$ .



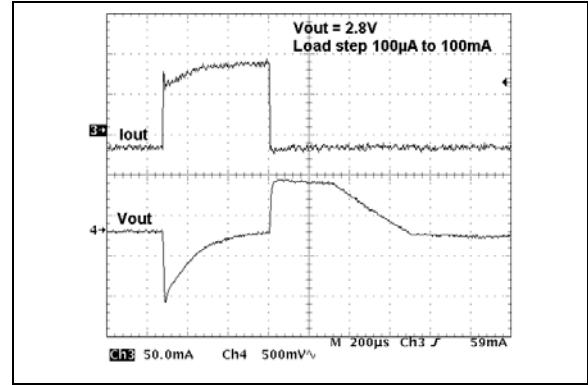
**FIGURE 2-25:** Power Supply Ripple Rejection vs. Frequency.



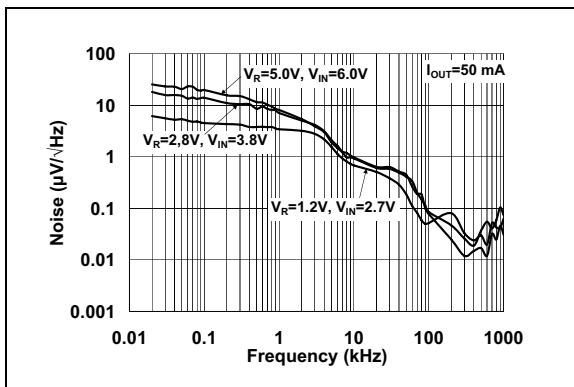
**FIGURE 2-28:** Power Up Timing.



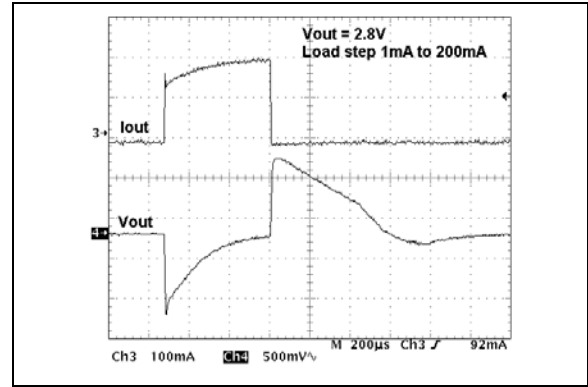
**FIGURE 2-26:** Power Supply Ripple Rejection vs. Frequency.



**FIGURE 2-29:** Dynamic Load Response.



**FIGURE 2-27:** Output Noise vs. Frequency.



**FIGURE 2-30:** Dynamic Load Response.

# MCP1702

---

## 3.0 PIN DESCRIPTIONS

The descriptions of the pins are listed in Table 3-1.

**TABLE 3-1: PIN FUNCTION TABLE**

Pin No. SOT-23A	Pin No. SOT-89	Pin No. TO-92	Symbol	Function
1	1	1	GND	Ground Terminal
2	3	3	V <sub>OUT</sub>	Regulated Voltage Output
3	2, Tab	2	V <sub>IN</sub>	Unregulated Supply Voltage
–	–	–	NC	No connection

### 3.1 Ground Terminal (GND)

Regulator ground. Tie GND to the negative side of the output and the negative side of the input capacitor. Only the LDO bias current (2.0  $\mu$ A typical) flows out of this pin; there is no high current. The LDO output regulation is referenced to this pin. Minimize voltage drops between this pin and the negative side of the load.

### 3.2 Regulated Output Voltage (V<sub>OUT</sub>)

Connect V<sub>OUT</sub> to the positive side of the load and the positive terminal of the output capacitor. The positive side of the output capacitor should be physically located as close to the LDO V<sub>OUT</sub> pin as is practical. The current flowing out of this pin is equal to the DC load current.

### 3.3 Unregulated Input Voltage Pin (V<sub>IN</sub>)

Connect V<sub>IN</sub> to the input unregulated source voltage. Like all LDO linear regulators, low source impedance is necessary for the stable operation of the LDO. The amount of capacitance required to ensure low source impedance will depend on the proximity of the input source capacitors or battery type. For most applications, 1  $\mu$ F of capacitance will ensure stable operation of the LDO circuit. For applications that have load currents below 100 mA, the input capacitance requirement can be lowered. The type of capacitor used can be ceramic, tantalum or aluminum electrolytic. The low ESR characteristics of the ceramic will yield better noise and PSRR performance at high-frequency.

## 4.0 DETAILED DESCRIPTION

### 4.1 Output Regulation

A portion of the LDO output voltage is fed back to the internal error amplifier and compared with the precision internal bandgap reference. The error amplifier output will adjust the amount of current that flows through the P-Channel pass transistor, thus regulating the output voltage to the desired value. Any changes in input voltage or output current will cause the error amplifier to respond and adjust the output voltage to the target voltage (refer to Figure 4-1).

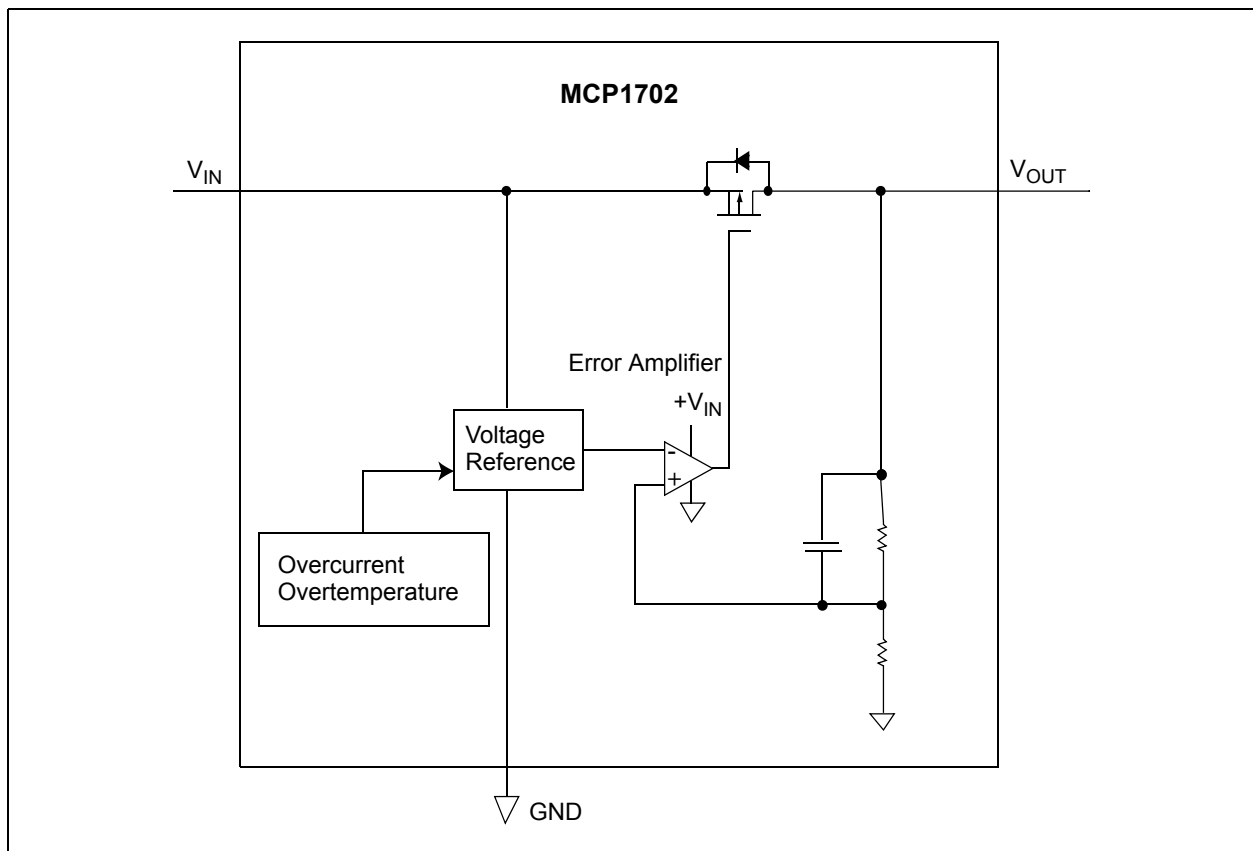
### 4.2 Overcurrent

The MCP1702 internal circuitry monitors the amount of current flowing through the P-Channel pass transistor. In the event of a short-circuit or excessive output current, the MCP1702 will turn off the P-Channel

device for a short period, after which the LDO will attempt to restart. If the excessive current remains, the cycle will repeat itself.

### 4.3 Overtemperature

The internal power dissipation within the LDO is a function of input-to-output voltage differential and load current. If the power dissipation within the LDO is excessive, the internal junction temperature will rise above the typical shutdown threshold of 150°C. At that point, the LDO will shut down and begin to cool to the typical turn-on junction temperature of 130°C. If the power dissipation is low enough, the device will continue to cool and operate normally. If the power dissipation remains high, the thermal shutdown protection circuitry will again turn off the LDO,



**FIGURE 4-1:** Block Diagram.

# MCP1702

---

## 5.0 FUNCTIONAL DESCRIPTION

The MCP1702 CMOS LDO linear regulator is intended for applications that need the lowest current consumption while maintaining output voltage regulation. The operating continuous load range of the MCP1702 is from 0 mA to 250 mA ( $V_R \geq 2.5V$ ). The input operating voltage range is from 2.7V to 13.2V, making it capable of operating from two or more alkaline cells or single and multiple Li-Ion cell batteries.

### 5.1 Input

The input of the MCP1702 is connected to the source of the P-Channel PMOS pass transistor. As with all LDO circuits, a relatively low source impedance ( $10\Omega$ ) is needed to prevent the input impedance from causing the LDO to become unstable. The size and type of the capacitor needed depends heavily on the input source type (battery, power supply) and the output current range of the application. For most applications (up to 100 mA), a 1  $\mu$ F ceramic capacitor will be sufficient to ensure circuit stability. Larger values can be used to improve circuit AC performance.

### 5.2 Output

The maximum rated continuous output current for the MCP1702 is 250 mA ( $V_R \geq 2.5V$ ). For applications where  $V_R < 2.5V$ , the maximum output current is 200 mA.

A minimum output capacitance of 1.0  $\mu$ F is required for small signal stability in applications that have up to 250 mA output current capability. The capacitor type can be ceramic, tantalum or aluminum electrolytic. The esr range on the output capacitor can range from  $0\Omega$  to  $2.0\Omega$ .

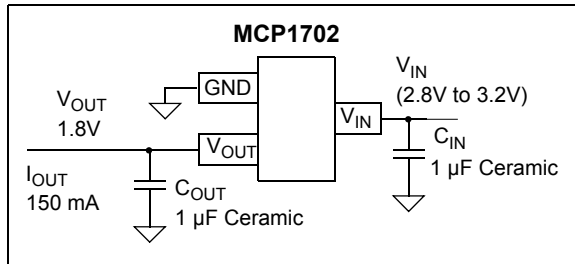
### 5.3 Output Rise time

When powering up the internal reference output, the typical output rise time of 500  $\mu$ s is controlled to prevent overshoot of the output voltage. There is also a startup delay time that ranges from 300  $\mu$ s to 800  $\mu$ s based on loading. The startup time is separate from and precedes the Output Rise Time. The total output delay is the Startup Delay plus the Output Rise time.

## 6.0 APPLICATION CIRCUITS AND ISSUES

### 6.1 Typical Application

The MCP1702 is most commonly used as a voltage regulator. Its low quiescent current and low dropout voltage makes it ideal for many battery-powered applications.



**FIGURE 6-1:** Typical Application Circuit.

#### 6.1.1 APPLICATION INPUT CONDITIONS

Package Type = SOT-23A

Input Voltage Range = 2.8V to 3.2V

$V_{IN}$  maximum = 3.2V

$V_{OUT}$  typical = 1.8V

$I_{OUT}$  = 150 mA maximum

## 6.2 Power Calculations

### 6.2.1 POWER DISSIPATION

The internal power dissipation of the MCP1702 is a function of input voltage, output voltage and output current. The power dissipation, as a result of the quiescent current draw, is so low, it is insignificant ( $2.0 \mu A \times V_{IN}$ ). The following equation can be used to calculate the internal power dissipation of the LDO.

#### EQUATION 6-1:

$$P_{LDO} = (V_{IN(MAX)} - V_{OUT(MIN)}) \times I_{OUT(MAX)}$$

Where:

$P_{LDO}$  = LDO Pass device internal power dissipation

$V_{IN(MAX)}$  = Maximum input voltage

$V_{OUT(MIN)}$  = LDO minimum output voltage

The maximum continuous operating junction temperature specified for the MCP1702 is +125°C. To estimate the internal junction temperature of the MCP1702, the total internal power dissipation is multiplied by the thermal resistance from junction to ambient ( $R\theta_{JA}$ ). The thermal resistance from junction to ambient for the SOT-23A pin package is estimated at 336 °C/W.

#### EQUATION 6-2:

$$T_{J(MAX)} = P_{TOTAL} \times R\theta_{JA} + T_{AMAX}$$

Where:

$T_{J(MAX)}$  = Maximum continuous junction temperature

$P_{TOTAL}$  = Total device power dissipation

$R\theta_{JA}$  = Thermal resistance from junction to ambient

$T_{AMAX}$  = Maximum ambient temperature

The maximum power dissipation capability for a package can be calculated given the junction-to-ambient thermal resistance and the maximum ambient temperature for the application. The following equation can be used to determine the package maximum internal power dissipation.

#### EQUATION 6-3:

$$P_{D(MAX)} = \frac{(T_{J(MAX)} - T_{A(MAX)})}{R\theta_{JA}}$$

Where:

$P_{D(MAX)}$  = Maximum device power dissipation

$T_{J(MAX)}$  = Maximum continuous junction temperature

$T_{A(MAX)}$  = Maximum ambient temperature

$R\theta_{JA}$  = Thermal resistance from junction to ambient

#### EQUATION 6-4:

$$T_{J(RISE)} = P_{D(MAX)} \times R\theta_{JA}$$

Where:

$T_{J(RISE)}$  = Rise in device junction temperature over the ambient temperature

$P_{TOTAL}$  = Maximum device power dissipation

$R\theta_{JA}$  = Thermal resistance from junction to ambient

#### EQUATION 6-5:

$$T_J = T_{J(RISE)} + T_A$$

Where:

$T_J$  = Junction Temperature

$T_{J(RISE)}$  = Rise in device junction temperature over the ambient temperature

$T_A$  = Ambient temperature

# MCP1702

## 6.3 Voltage Regulator

Internal power dissipation, junction temperature rise, junction temperature and maximum power dissipation are calculated in the following example. The power dissipation, as a result of ground current, is small enough to be neglected.

### 6.3.1 POWER DISSIPATION EXAMPLE

#### Package

Package Type = SOT23

Input Voltage

$$V_{IN} = 2.8V \text{ to } 3.2V$$

#### LDO Output Voltages and Currents

$$V_{OUT} = 1.8V$$

$$I_{OUT} = 150 \text{ mA}$$

#### Maximum Ambient Temperature

$$T_{A(MAX)} = +40^{\circ}\text{C}$$

#### Internal Power Dissipation

Internal Power dissipation is the product of the LDO output current times the voltage across the LDO ( $V_{IN}$  to  $V_{OUT}$ ).

$$P_{LDO(MAX)} = (V_{IN(MAX)} - V_{OUT(MIN)}) \times I_{OUT(MAX)}$$

$$P_{LDO} = (3.2V - (0.97 \times 1.8V)) \times 150 \text{ mA}$$

$$P_{LDO} = 218.1 \text{ milli-Watts}$$

## Device Junction Temperature Rise

The internal junction temperature rise is a function of internal power dissipation and the thermal resistance from junction to ambient for the application. The thermal resistance from junction to ambient ( $R_{\theta JA}$ ) is derived from an EIA/JEDEC standard for measuring thermal resistance for small surface mount packages. The EIA/JEDEC specification is JESD51-7, "High Effective Thermal Conductivity Test Board for Leaded Surface Mount Packages". The standard describes the test method and board specifications for measuring the thermal resistance from junction to ambient. The actual thermal resistance for a particular application can vary depending on many factors, such as copper area and thickness. Refer to AN792, "A Method to Determine How Much Power a SOT23 Can Dissipate in an Application", (DS00792), for more information regarding this subject.

$$T_{J(RISE)} = P_{TOTAL} \times R_{QJA}$$

$$T_{JRISE} = 218.1 \text{ milli-Watts} \times 336.0^{\circ}\text{C/Watt}$$

$$T_{JRISE} = 73.3^{\circ}\text{C}$$

## Junction Temperature Estimate

To estimate the internal junction temperature, the calculated temperature rise is added to the ambient or offset temperature. For this example, the worst-case junction temperature is estimated below.

$$T_J = T_{JRISE} + T_{A(MAX)}$$

$$T_J = 113.3^{\circ}\text{C}$$

### Maximum Package Power Dissipation at +40°C Ambient Temperature

SOT23 ( $336.0^{\circ}\text{C/Watt} = R_{\theta JA}$ )

$$P_{D(MAX)} = (125^{\circ}\text{C} - 40^{\circ}\text{C}) / 336^{\circ}\text{C/W}$$

$$P_{D(MAX)} = 253 \text{ milli-Watts}$$

SOT89 ( $52^{\circ}\text{C/Watt} = R_{\theta JA}$ )

$$P_{D(MAX)} = (125^{\circ}\text{C} - 40^{\circ}\text{C}) / 52^{\circ}\text{C/W}$$

$$P_{D(MAX)} = 1.635 \text{ Watts}$$

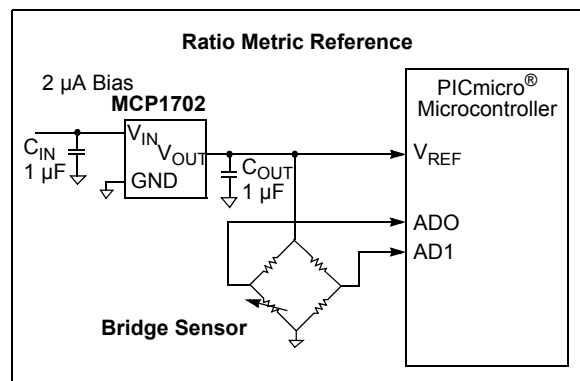
TO92 ( $131.9^{\circ}\text{C/Watt} = R_{\theta JA}$ )

$$P_{D(MAX)} = (125^{\circ}\text{C} - 40^{\circ}\text{C}) / 131.9^{\circ}\text{C/W}$$

$$P_{D(MAX)} = 644 \text{ milli-Watts}$$

## 6.4 Voltage Reference

The MCP1702 can be used not only as a regulator, but also as a low quiescent current voltage reference. In many microcontroller applications, the initial accuracy of the reference can be calibrated using production test equipment or by using a ratio measurement. When the initial accuracy is calibrated, the thermal stability and line regulation tolerance are the only errors introduced by the MCP1702 LDO. The low-cost, low quiescent current and small ceramic output capacitor are all advantages when using the MCP1702 as a voltage reference.



**FIGURE 6-2:** Using the MCP1702 as a voltage reference.

## 6.5 Pulsed Load Applications

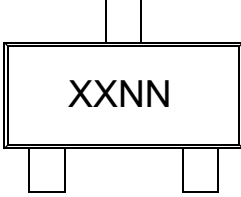
For some applications, there are pulsed load current events that may exceed the specified 250 mA maximum specification of the MCP1702. The internal current limit of the MCP1702 will prevent high peak load demands from causing non-recoverable damage. The 250 mA rating is a maximum average continuous rating. As long as the average current does not exceed 250 mA, pulsed higher load currents can be applied to the MCP1702. The typical current limit for the MCP1702 is 500 mA ( $T_A +25^\circ\text{C}$ ).

# MCP1702

## 7.0 PACKAGING INFORMATION

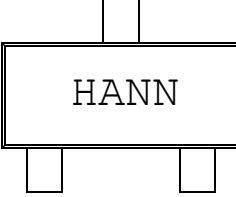
### 7.1 Package Marking Information

**3-Pin SOT-23A**



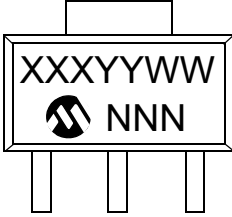
Standard			
Extended Temp			
Symbol	Voltage *	Symbol	Voltage *
HA	1.2	HF	3.0
HB	1.5	HG	3.3
HC	1.8	HH	4.0
HD	2.5	HJ	5.0
HE	2.8	—	—

Example:




\* Custom output voltages available upon request. Contact your local Microchip sales office for more information.

**3-Lead SOT-89**



Standard			
Extended Temp			
Symbol	Voltage *	Symbol	Voltage *
HA	1.2	HF	3.0
HB	1.5	HG	3.3
HC	1.8	HH	4.0
HD	2.5	HJ	5.0
HE	2.8	—	—

Example



\* Custom output voltages available upon request. Contact your local Microchip sales office for more information.

**3-Lead TO-92**



Example



**Legend:**

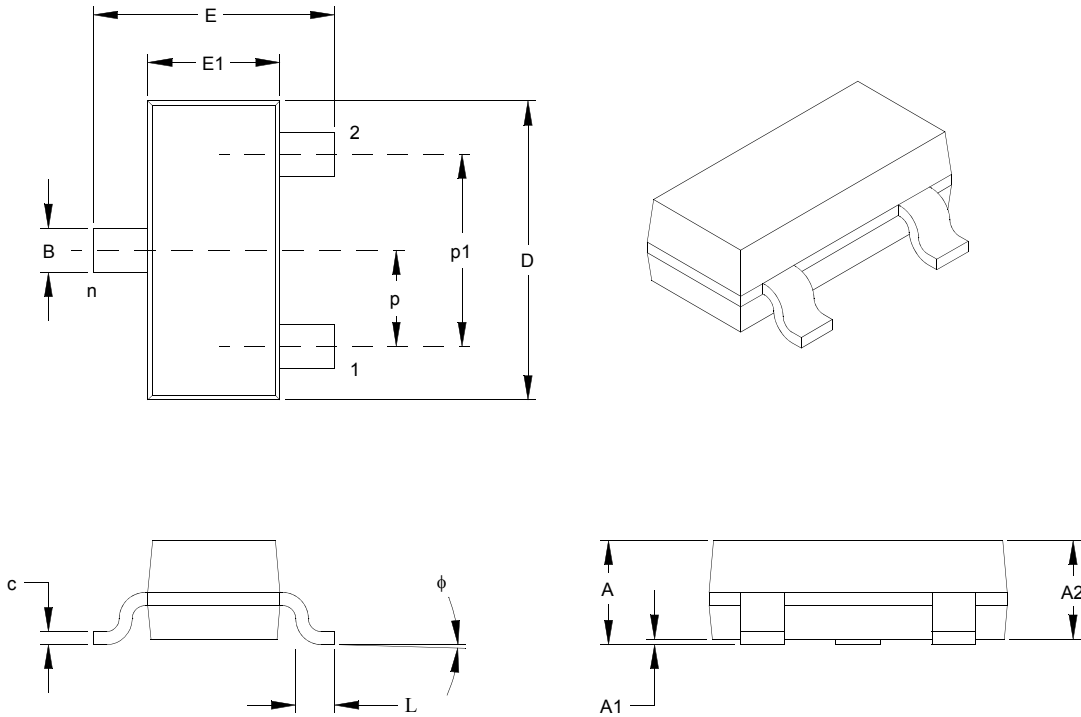
- XX...X Customer-specific information
- Y Year code (last digit of calendar year)
- YY Year code (last 2 digits of calendar year)
- WW Week code (week of January 1 is week '01')
- NNN Alphanumeric traceability code
- e3 Pb-free JEDEC designator for Matte Tin (Sn)
- \* This package is Pb-free. The Pb-free JEDEC designator (e3) can be found on the outer packaging for this package.

**Note:** In the event the full Microchip part number cannot be marked on one line, it will be carried over to the next line, thus limiting the number of available characters for customer-specific information.



## 3-Lead Plastic Small Outline Transistor (CB) (SOT-23A)

**Note:** For the most current package drawings, please see the Microchip Packaging Specification located at <http://www.microchip.com/packaging>



Units		INCHES			MILLIMETERS*		
Dimension Limits		MIN	NOM	MAX	MIN	NOM	MAX
Number of Pins	n	3			3		
Pitch	p	.037 BSC			0.95 BSC		
Outside lead pitch (basic)	p1	.075 BSC			1.90 BSC		
Overall Height	A	.035		.055	0.90	-	1.40
Molded Package Thickness	A2	.035	-	.051	0.90	-	1.30
Standoff	A1	.000	-	.006	0.00	-	0.15
Overall Width	E	.098	-	.118	2.50	-	3.00
Molded Package Width	E1	.055	-	.071	1.40	-	1.80
Overall Length	D	.106	-	.122	2.70	-	3.10
Foot Length	L	.014	-	.022	0.35	-	0.55
Foot Angle	$\phi$	0°	-	10°	0°	-	10°
Lead Thickness	c	.004	-	.014	0.10	-	0.35
Lead Width	B	.012	-	.019	0.30	-	0.50

\* Controlling Parameter

**Notes:**

Dimensions D and E1 do not include mold flash or protrusions. Mold flash or protrusions shall not exceed .005" (0.127mm) per side.

BSC: Basic Dimension. Theoretically exact value shown without tolerances.

See ASME Y14.5M

EIAJ Equivalent: SC-59

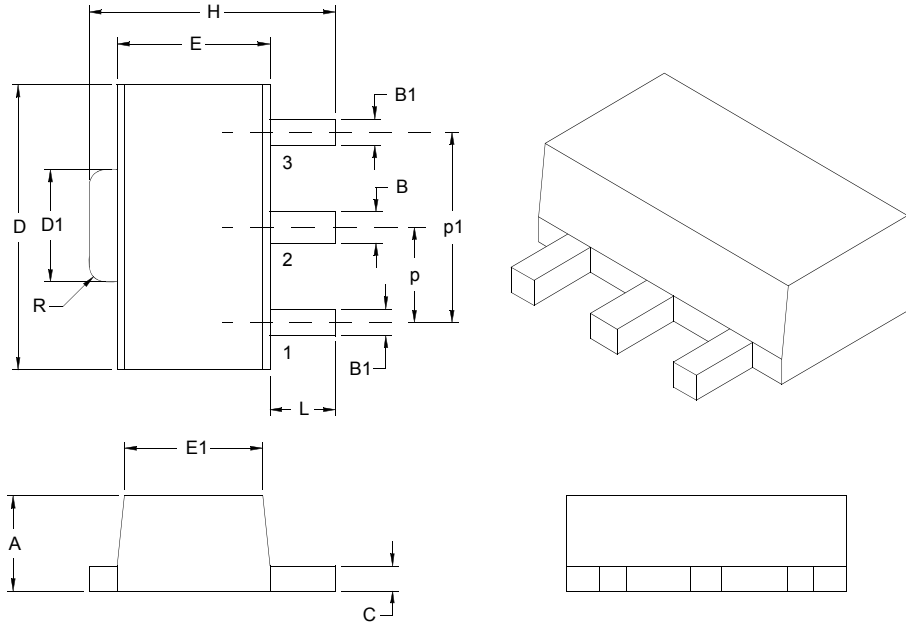
Drawing No. C04-130

Revised 09-14-05

# MCP1702

## 3-Lead Plastic Small Outline Transistor Header (MB) (SOT-89)

**Note:** For the most current package drawings, please see the Microchip Packaging Specification located at <http://www.microchip.com/packaging>



Dimension Limits	Units	INCHES		MILLIMETERS*	
		MIN	MAX	MIN	MAX
Pitch	P	.059 BSC		1.50 BSC	
Outside Lead Pitch	p1	.118 BSC		3.00 BSC	
Overall Height	A	.055	.063	1.40	1.60
Overall Width	H	.155	.167	3.94	4.25
Molded Package Width at Base	E	.090	.102	2.29	2.60
Molded Package Width at Top	E1	.084	.090	2.13	2.29
Overall Length	D	.173	.181	4.40	4.60
Tab Length	D1	.064	.072	1.62	1.83
Tab Corner Radii	R	.010		0.254	
Foot Length	L	.035	.047	0.89	1.20
Lead Thickness	c	.014	.019	0.35	0.48
Lead 2 Width	B	.017	.022	0.43	0.56
Leads 1 & 3 Width	B1	.014	.019	0.36	0.48

\* Controlling Parameter

**Notes:**

Dimensions D and E1 do not include mold flash or protrusions. Mold flash or protrusions shall not exceed .005" (0.127mm) per side.

BSC: Basic Dimension. Theoretically exact value shown without tolerances.

See ASME Y14.5M

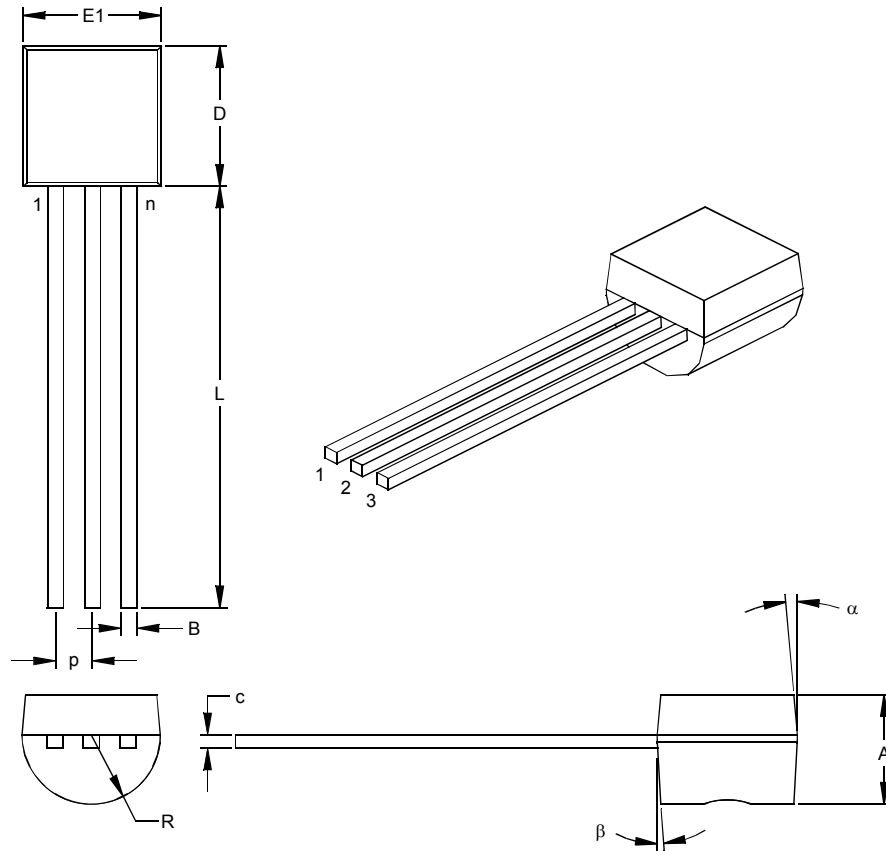
JEDEC Equivalent: TO-243

Drawing No. C04-029

Revised 09-19-03

## 3-Lead Plastic Transistor Outline (TO) (TO-92)

**Note:** For the most current package drawings, please see the Microchip Packaging Specification located at <http://www.microchip.com/packaging>



Dimension	Units	INCHES*			MILLIMETERS		
		MIN	NOM	MAX	MIN	NOM	MAX
Number of Pins	n	3			3		
Pitch	p		.050			1.27	
Bottom to Package Flat	A	.130	.143	.155	3.30	3.62	3.94
Overall Width	E1	.175	.186	.195	4.45	4.71	4.95
Overall Length	D	.170	.183	.195	4.32	4.64	4.95
Molded Package Radius	R	.085	.090	.095	2.16	2.29	2.41
Tip to Seating Plane	L	.500	.555	.610	12.70	14.10	15.49
Lead Thickness	c	.014	.017	.020	0.36	0.43	0.51
Lead Width	B	.016	.019	.022	0.41	0.48	0.56
Mold Draft Angle Top	$\alpha$	4	5	6	4	5	6
Mold Draft Angle Bottom	$\beta$	2	3	4	2	3	4

\* Controlling Parameter

**Notes:**

Dimensions D and E1 do not include mold flash or protrusions. Mold flash or protrusions shall not exceed .010" (0.254mm) per side.

JEDEC Equivalent: TO-92

Drawing No. C04-101

# MCP1702

---

NOTES:

## APPENDIX A: REVISION HISTORY

### Revision A (September 2006)

- Original Release of this Document.

# MCP1702

---

NOTES:

## PRODUCT IDENTIFICATION SYSTEM

To order or obtain information, e.g., on pricing or delivery, refer to the factory or the listed sales office.

<u>PART NO.</u>	<u>X-</u>	<u>XX</u>	<u>X</u>	<u>X</u>	<u>X/</u>	<u>XX</u>	<b>Examples:</b>
Device	Tape and Reel	Output Voltage	Feature Code	Tolerance	Temp.	Package	
<p>Device: MCP1702: 2 <math>\mu</math>A Low Dropout Positive Voltage Regulator</p> <p>Tape and Reel: T = Tape and Reel</p> <p>Output Voltage *:</p> <ul style="list-style-type: none"> <li>12 = 1.2V "Standard"</li> <li>15 = 1.5V "Standard"</li> <li>18 = 1.8V "Standard"</li> <li>25 = 2.5V "Standard"</li> <li>28 = 2.8V "Standard"</li> <li>30 = 3.0V "Standard"</li> <li>33 = 3.3V "Standard"</li> <li>40 = 4.0V "Standard"</li> <li>50 = 5.0V "Standard"</li> </ul> <p>*Contact factory for other output voltage options.</p> <p>Extra Feature Code: 0 = Fixed</p> <p>Tolerance: 2 = 2.0% (Standard)</p> <p>Temperature: E = -40°C to +125°C</p> <p>Package Type:</p> <ul style="list-style-type: none"> <li>CB = 3-Pin SOT-23A (equivalent to EIAJ SC-59)</li> <li>MB = 3-Pin SOT-89</li> <li>TO = 3-Pin TO-92</li> </ul>							
							a) MCP1702T-1202I/CB: 1.2V LDO Positive Voltage Regulator, SOT-23A-3 pkg.
							b) MCP1702T-1802I/MB: 1.8V LDO Positive Voltage Regulator, SOT89-3 pkg.
							c) MCP1702T-2502I/CB: 2.5V LDO Positive Voltage Regulator, SOT-23A-3 pkg.
							d) MCP1702T-3002I/CB: 3.0V LDO Positive Voltage Regulator, SOT-23A-3 pkg.
							e) MCP1702T-3002I/MB: 3.0V LDO Positive Voltage Regulator, SOT89-3 pkg.
							f) MCP1702T-3302I/CB: 3.3V LDO Positive Voltage Regulator, SOT-23A-3 pkg.
							g) MCP1702T-3302I/MB: 3.3V LDO Positive Voltage Regulator, SOT89-3 pkg.
							h) MCP1702T-4002I/CB: 4.0V LDO Positive Voltage Regulator, SOT-23A-3 pkg.
							i) MCP1702T-5002I/TO: 5.0V LDO Positive Voltage Regulator, TO-92 pkg.
							j) MCP1702T-5002I/CB: 5.0V LDO Positive Voltage Regulator, SOT-23A-3 pkg.
							k) MCP1702T-5002I/MB: 5.0V LDO Positive Voltage Regulator, SOT89-3 pkg.

# MCP1702

---

NOTES:



---

**Note the following details of the code protection feature on Microchip devices:**

- Microchip products meet the specification contained in their particular Microchip Data Sheet.
- Microchip believes that its family of products is one of the most secure families of its kind on the market today, when used in the intended manner and under normal conditions.
- There are dishonest and possibly illegal methods used to breach the code protection feature. All of these methods, to our knowledge, require using the Microchip products in a manner outside the operating specifications contained in Microchip's Data Sheets. Most likely, the person doing so is engaged in theft of intellectual property.
- Microchip is willing to work with the customer who is concerned about the integrity of their code.
- Neither Microchip nor any other semiconductor manufacturer can guarantee the security of their code. Code protection does not mean that we are guaranteeing the product as “unbreakable.”

Code protection is constantly evolving. We at Microchip are committed to continuously improving the code protection features of our products. Attempts to break Microchip's code protection feature may be a violation of the Digital Millennium Copyright Act. If such acts allow unauthorized access to your software or other copyrighted work, you may have a right to sue for relief under that Act.

---

Information contained in this publication regarding device applications and the like is provided only for your convenience and may be superseded by updates. It is your responsibility to ensure that your application meets with your specifications. MICROCHIP MAKES NO REPRESENTATIONS OR WARRANTIES OF ANY KIND WHETHER EXPRESS OR IMPLIED, WRITTEN OR ORAL, STATUTORY OR OTHERWISE, RELATED TO THE INFORMATION, INCLUDING BUT NOT LIMITED TO ITS CONDITION, QUALITY, PERFORMANCE, MERCHANTABILITY OR FITNESS FOR PURPOSE. Microchip disclaims all liability arising from this information and its use. Use of Microchip devices in life support and/or safety applications is entirely at the buyer's risk, and the buyer agrees to defend, indemnify and hold harmless Microchip from any and all damages, claims, suits, or expenses resulting from such use. No licenses are conveyed, implicitly or otherwise, under any Microchip intellectual property rights.

**Trademarks**

The Microchip name and logo, the Microchip logo, Accuron, dsPIC, KEELOQ, microID, MPLAB, PIC, PICmicro, PICSTART, PRO MATE, PowerSmart, rfPIC, and SmartShunt are registered trademarks of Microchip Technology Incorporated in the U.S.A. and other countries.

AmpLab, FilterLab, Migratable Memory, MXDEV, MXLAB, SEEVAL, SmartSensor and The Embedded Control Solutions Company are registered trademarks of Microchip Technology Incorporated in the U.S.A.

Analog-for-the-Digital Age, Application Maestro, CodeGuard, dsPICDEM, dsPICDEM.net, dsPICworks, ECAN, ECONOMONITOR, FanSense, FlexROM, fuzzyLAB, In-Circuit Serial Programming, ICSP, ICEPIC, Linear Active Thermistor, Mindi, MiWi, MPASM, MPLIB, MPLINK, PICkit, PICDEM, PICDEM.net, PICLAB, PICtail, PowerCal, PowerInfo, PowerMate, PowerTool, REAL ICE, rFLAB, rfPICDEM, Select Mode, Smart Serial, SmartTel, Total Endurance, UNI/O, WiperLock and ZENA are trademarks of Microchip Technology Incorporated in the U.S.A. and other countries.

SQTP is a service mark of Microchip Technology Incorporated in the U.S.A.

All other trademarks mentioned herein are property of their respective companies.

© 2006, Microchip Technology Incorporated, Printed in the U.S.A., All Rights Reserved.

 Printed on recycled paper.

**QUALITY MANAGEMENT SYSTEM**  
**CERTIFIED BY DNV**  
**== ISO/TS 16949:2002 ==**

*Microchip received ISO/TS-16949:2002 certification for its worldwide headquarters, design and wafer fabrication facilities in Chandler and Tempe, Arizona, Gresham, Oregon and Mountain View, California. The Company's quality system processes and procedures are for its PICmicro® 8-bit MCUs, KEELOQ® code hopping devices, Serial EEPROMs, microperipherals, nonvolatile memory and analog products. In addition, Microchip's quality system for the design and manufacture of development systems is ISO 9001:2000 certified.*



**MICROCHIP**

---

---

## WORLDWIDE SALES AND SERVICE

---

---

### AMERICAS

#### Corporate Office

2355 West Chandler Blvd.  
Chandler, AZ 85224-6199  
Tel: 480-792-7200  
Fax: 480-792-7277  
Technical Support:  
<http://support.microchip.com>  
Web Address:  
[www.microchip.com](http://www.microchip.com)

#### Atlanta

Alpharetta, GA  
Tel: 770-640-0034  
Fax: 770-640-0307

#### Boston

Westborough, MA  
Tel: 774-760-0087  
Fax: 774-760-0088

#### Chicago

Itasca, IL  
Tel: 630-285-0071  
Fax: 630-285-0075

#### Dallas

Addison, TX  
Tel: 972-818-7423  
Fax: 972-818-2924

#### Detroit

Farmington Hills, MI  
Tel: 248-538-2250  
Fax: 248-538-2260

#### Kokomo

Kokomo, IN  
Tel: 765-864-8360  
Fax: 765-864-8387

#### Los Angeles

Mission Viejo, CA  
Tel: 949-462-9523  
Fax: 949-462-9608

#### Santa Clara

Santa Clara, CA  
Tel: 408-961-6444  
Fax: 408-961-6445

#### Toronto

Mississauga, Ontario,  
Canada  
Tel: 905-673-0699  
Fax: 905-673-6509

### ASIA/PACIFIC

#### Asia Pacific Office

Suites 3707-14, 37th Floor  
Tower 6, The Gateway  
Harbour City, Kowloon  
Hong Kong  
Tel: 852-2401-1200  
Fax: 852-2401-3431

#### Australia - Sydney

Tel: 61-2-9868-6733  
Fax: 61-2-9868-6755

#### China - Beijing

Tel: 86-10-8528-2100  
Fax: 86-10-8528-2104

#### China - Chengdu

Tel: 86-28-8665-5511  
Fax: 86-28-8665-7889

#### China - Fuzhou

Tel: 86-591-8750-3506  
Fax: 86-591-8750-3521

#### China - Hong Kong SAR

Tel: 852-2401-1200  
Fax: 852-2401-3431

#### China - Qingdao

Tel: 86-532-8502-7355  
Fax: 86-532-8502-7205

#### China - Shanghai

Tel: 86-21-5407-5533  
Fax: 86-21-5407-5066

#### China - Shenyang

Tel: 86-24-2334-2829  
Fax: 86-24-2334-2393

#### China - Shenzhen

Tel: 86-755-8203-2660  
Fax: 86-755-8203-1760

#### China - Shunde

Tel: 86-757-2839-5507  
Fax: 86-757-2839-5571

#### China - Wuhan

Tel: 86-27-5980-5300  
Fax: 86-27-5980-5118

#### China - Xian

Tel: 86-29-8833-7250  
Fax: 86-29-8833-7256

### ASIA/PACIFIC

#### India - Bangalore

Tel: 91-80-4182-8400  
Fax: 91-80-4182-8422

#### India - New Delhi

Tel: 91-11-4160-8631  
Fax: 91-11-4160-8632

#### India - Pune

Tel: 91-20-2566-1512  
Fax: 91-20-2566-1513

#### Japan - Yokohama

Tel: 81-45-471-6166  
Fax: 81-45-471-6122

#### Korea - Gumi

Tel: 82-54-473-4301  
Fax: 82-54-473-4302

#### Korea - Seoul

Tel: 82-2-554-7200  
Fax: 82-2-558-5932 or  
82-2-558-5934

#### Malaysia - Penang

Tel: 60-4-646-8870  
Fax: 60-4-646-5086

#### Philippines - Manila

Tel: 63-2-634-9065  
Fax: 63-2-634-9069

#### Singapore

Tel: 65-6334-8870  
Fax: 65-6334-8850

#### Taiwan - Hsin Chu

Tel: 886-3-572-9526  
Fax: 886-3-572-6459

#### Taiwan - Kaohsiung

Tel: 886-7-536-4818  
Fax: 886-7-536-4803

#### Taiwan - Taipei

Tel: 886-2-2500-6610  
Fax: 886-2-2508-0102

#### Thailand - Bangkok

Tel: 66-2-694-1351  
Fax: 66-2-694-1350

### EUROPE

#### Austria - Wels

Tel: 43-7242-2244-3910  
Fax: 43-7242-2244-393

#### Denmark - Copenhagen

Tel: 45-4450-2828  
Fax: 45-4485-2829

#### France - Paris

Tel: 33-1-69-53-63-20  
Fax: 33-1-69-30-90-79

#### Germany - Munich

Tel: 49-89-627-144-0  
Fax: 49-89-627-144-44

#### Italy - Milan

Tel: 39-0331-742611  
Fax: 39-0331-466781

#### Netherlands - Drunen

Tel: 31-416-690399  
Fax: 31-416-690340

#### Spain - Madrid

Tel: 34-91-708-08-90  
Fax: 34-91-708-08-91

#### UK - Wokingham

Tel: 44-118-921-5869  
Fax: 44-118-921-5820

08/29/06