

4 Watt Ka Band HPA

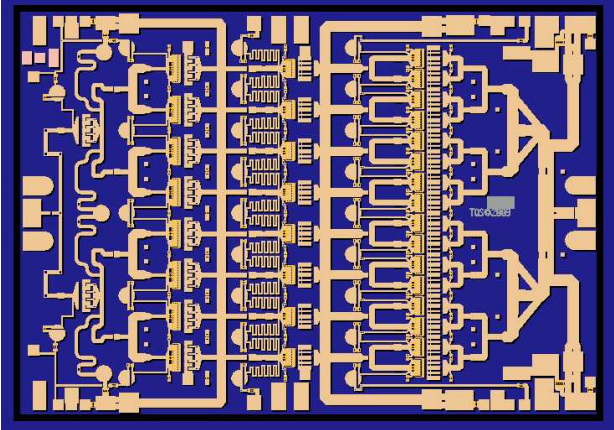

Key Features

- Frequency Range: 24-31 GHz
- 23 dB Nominal Gain
- 35.5 dBm Nominal P1dB @30 GHz
- 36.0 dBm Nominal Psat @30 GHz
- 40 dBc at SCL Pout 20dBm
- 0.25 um pHEMT 2MI Technology
- Bias 6 V @ 2.1 A Idq
- Chip size 4.29 x 3.02 x .05 mm (0.169 x 0.119 x 0.002 in)

Primary Applications

- Satellite Ground Terminal
- Point-to-Point Radio

Product Description

The TriQuint TGA4505 is a compact 4 Watt High Power Amplifier MMIC for Ka-band applications. The part is designed using TriQuint's proven standard 0.25 um gate Power pHEMT production process.

The TGA4505 provides a nominal 35.5 dBm of output power at 1 dB gain compression from 24-32 GHz with a small signal gain of 23 dB.

The part is ideally suited for low cost emerging markets such as base station transmitters for satellite ground terminals and point to point radio.

The TGA4505 is 100% DC and RF tested on-wafer to ensure performance compliance.

Lead-free and RoHS compliant.

Fixtured Data
Bias Conditions: Vd = 6 V, Idq = 2.1A

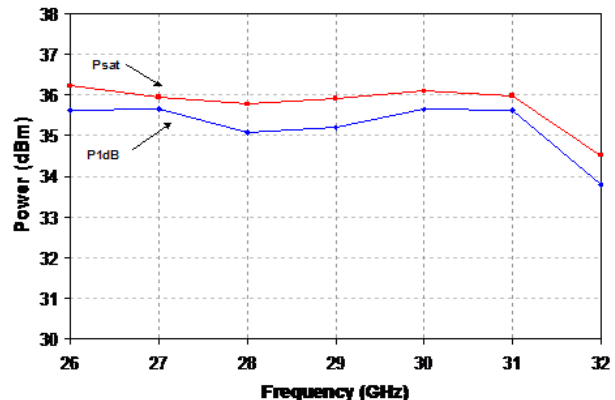
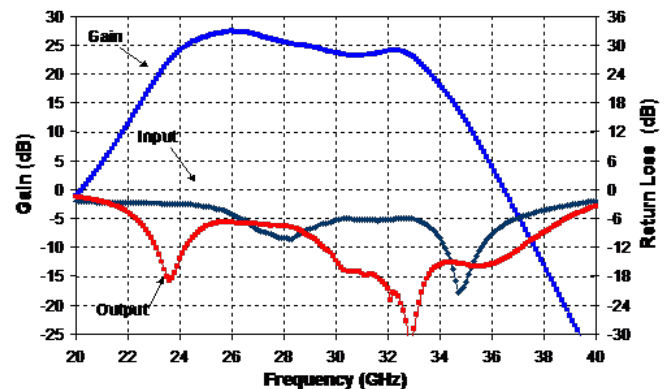

**TABLE I
MAXIMUM RATINGS**

Symbol	Parameter <u>1/</u>	Value	Notes
V ⁺	Positive Supply Voltage	8 V	<u>2/</u>
V ⁻	Negative Supply Voltage Range	-5V TO 0V	
I ⁺	Positive Supply Current:	4 A	<u>2/</u>
I _G	Gate Supply Current	62 mA	
P _{IN}	Input Continuous Wave Power	24 dBm	<u>2/</u>
P _D	Power Dissipation	27.7 W	<u>2/</u> , <u>3/</u>
T _{CH}	Operating Channel Temperature	200 °C	<u>4/</u> , <u>5/</u>
	Mounting Temperature (30 Seconds)	320 °C	
T _{STG}	Storage Temperature	-65 to 150 °C	

- 1/ These ratings represent the maximum operable values for this device.
- 2/ Combinations of supply voltage, supply current, input power, and output power shall not exceed P_D.
- 3/ When operated at this bias condition with a base plate temperature of 70 °C, the median life is 2.3E4 hours.
- 4/ Junction operating temperature will directly affect the device median time to failure (T_m). For maximum life, it is recommended that junction temperatures be maintained at the lowest possible levels.
- 5/ These ratings apply to each individual FET.

**TABLE II
DC PROBE TEST
(T_A = 25 °C, nominal)**

NOTES	SYMBOL	LIMITS		UNITS
		MIN	MAX	
<u>1/</u>	I _{DSS(Q35)}	15	70.5	mA
<u>1/</u>	G _{M(Q35)}	33	79.5	mS
<u>1/</u> , <u>2/</u>	V _{P(Q1, Q9, Q35)}	0.5	1.5	V
<u>1/</u> , <u>2/</u>	V _{BVGS(Q35)}	11	30	V
<u>1/</u> , <u>2/</u>	V _{BVGD(Q35)}	11	30	V

- 1/ Q35 is a 150 um Test FET
2/ V_P, V_{BVGD}, and V_{BVGS} are negative.

TABLE III
RF CHARACTERIZATION TABLE
 (T_A = 25°C, Nominal)
 (V_d = 6V, I_d = 2.1A)

SYMBOL	PARAMETER	TEST CONDITION	TYPICAL	UNITS
Gain	Small Signal Gain	F = 24-31 GHz	23	dB
IRL	Input Return Loss	F = 24-31 GHz	6	dB
ORL	Output Return Loss	F = 24-31 GHz	12	dB
PWR	Output Power @ P1dB	F = 24-31 GHz	35	dBm

Note: Table III Lists the RF Characteristics of typical devices as determined by fixtured measurements.

TABLE IV
THERMAL INFORMATION

Parameter	Test Conditions	T _{CH} (°C)	θ _{JC} (°C/W)	T _m (HRS)
θ _{JC} Thermal Resistance (channel to backside of carrier)	V _d = 6V I _D = 2.05 A P _{diss} = 12.3 W	128	4.7	7.4E+6

Note: Assumes eutectic attach using 1.5 mil 80/20 AuSn mounted to a 20 mil CuMo Carrier at 70 °C baseplate temperature. Worst case is at saturated output power when DC power consumption rises to 23 W with 4 W RF power delivered to load. Power dissipated is 19 W and the temperature rise in the channel is 88 °C.

Median Lifetime (T_m) vs. Channel Temperature

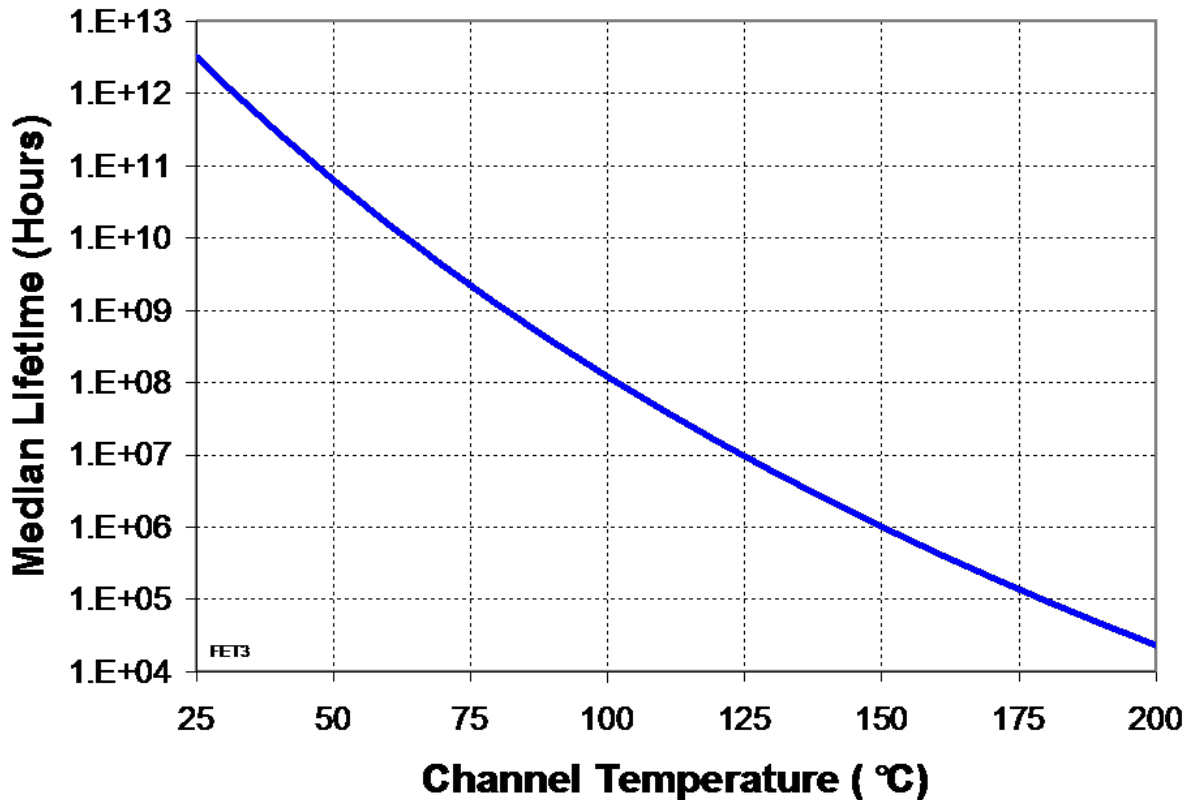

Measured Fixtured Data
Bias Conditions: $V_d = 6\text{ V}$, $I_d = 2.1\text{ A}$

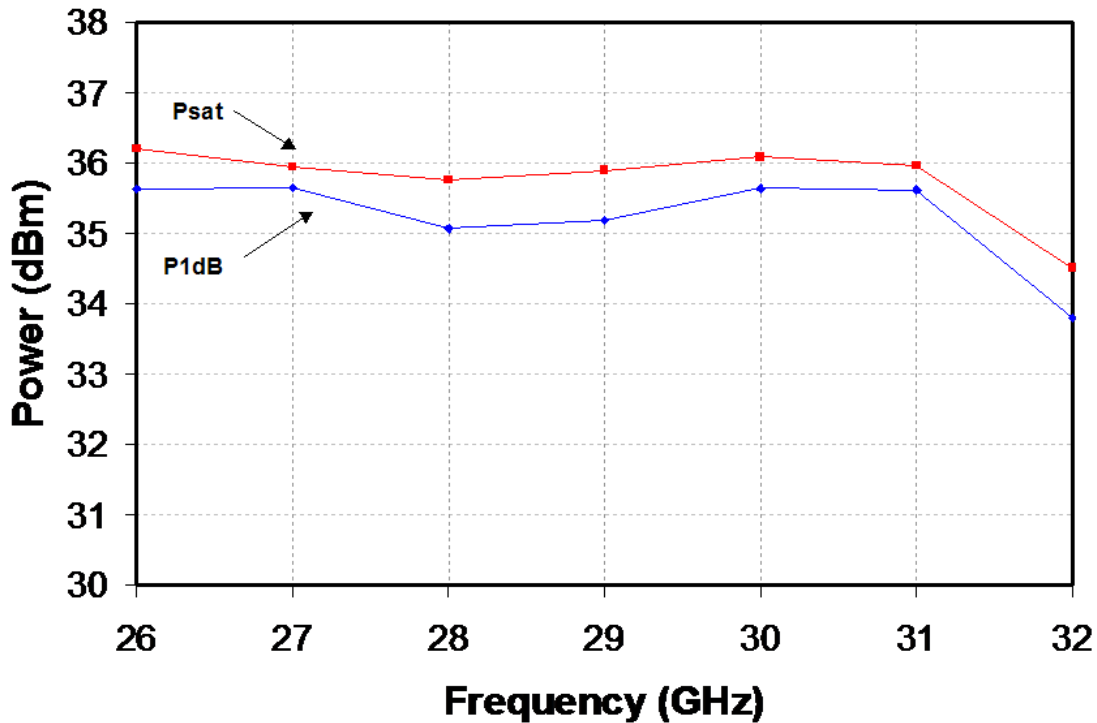
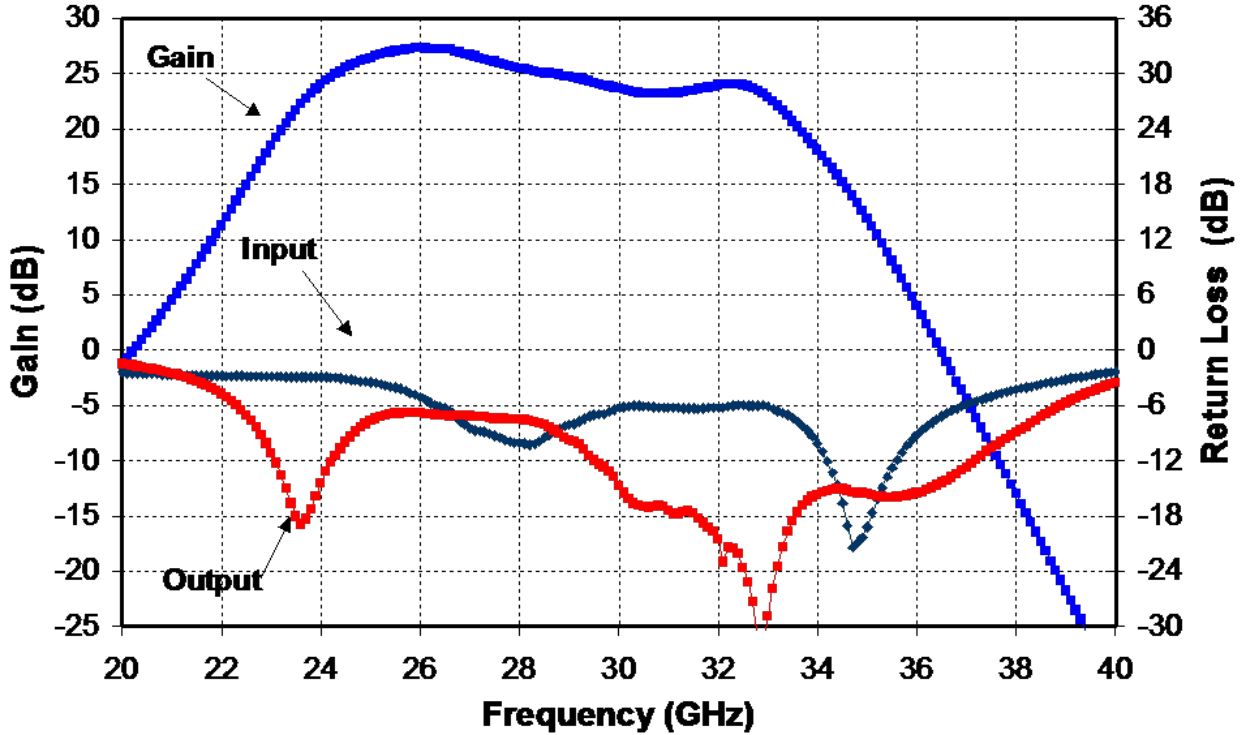

Measured Fixtured Data

Bias Conditions: $V_d = 6\text{ V}$, $I_d = 2.1\text{ A}$

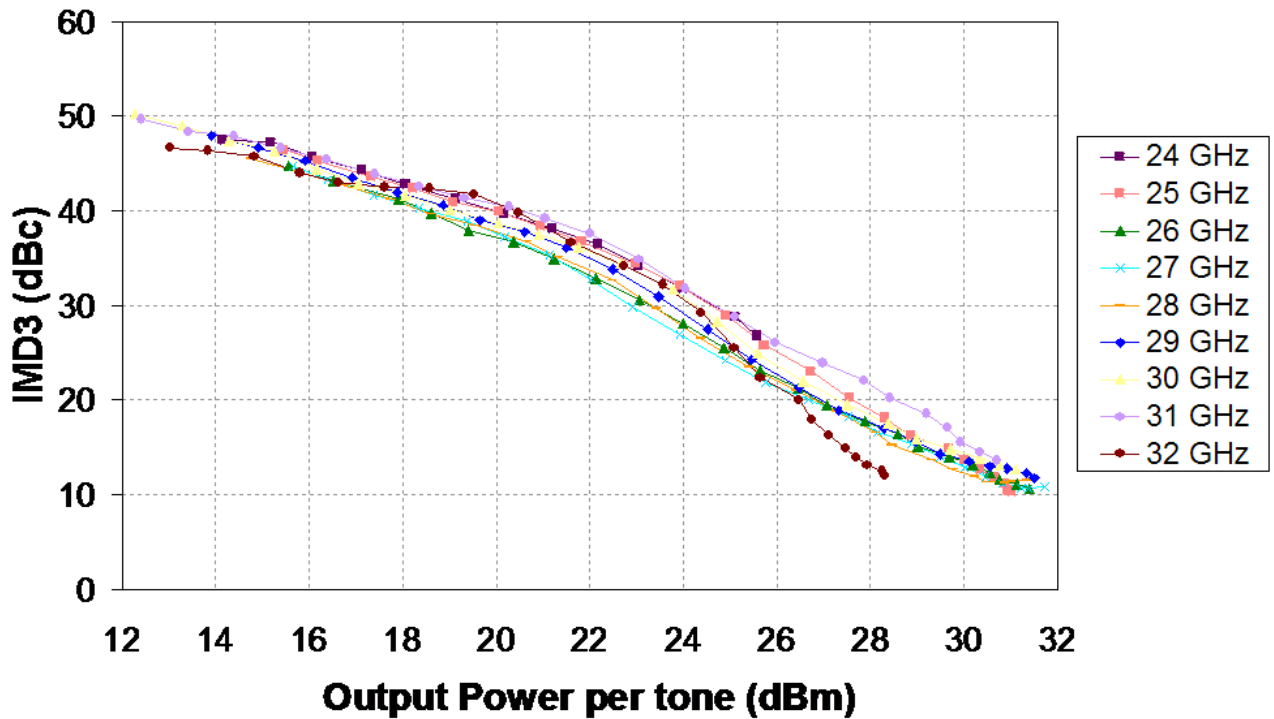
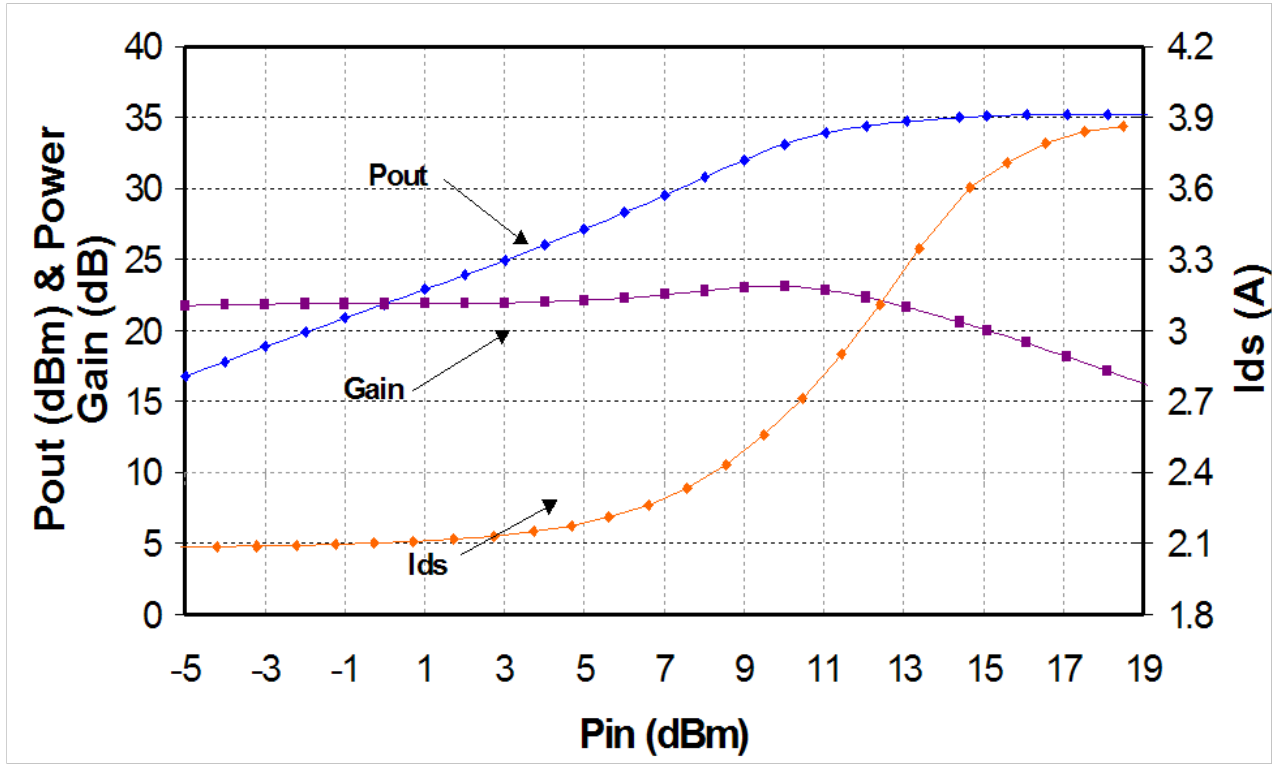

Mechanical Drawing

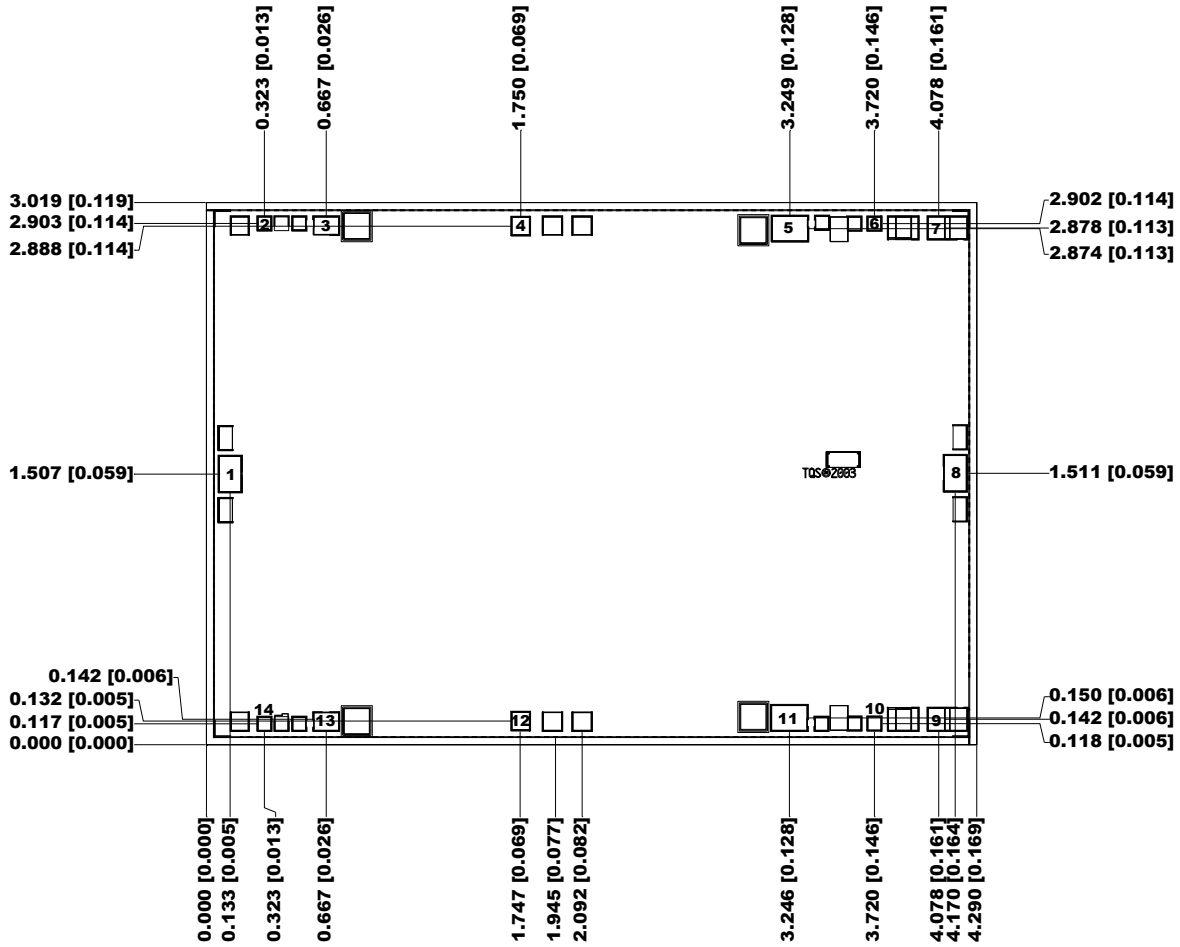

Units: millimeters (inches)
 Thickness: 0.050 (0.002) (reference only)
 Chip edge to bond pad dimensions are shown to center of pad
 Chip size: +/- 0.051 (0.002)

GND IS BACKSIDE OF MMIC

Bond Pad #1:	RF IN	0.130 x 0.205 (0.005 x 0.008)
Bond Pad #2:	VG1	0.080 x 0.080 (0.003 x 0.003)
Bond Pad #3:	VD1	0.143 x 0.103 (0.006 x 0.004)
Bond Pad #4:	VG2	0.105 x 0.105 (0.004 x 0.004)
Bond Pad #5:	VD2	0.205 x 0.105 (0.008 x 0.004)
Bond Pad #6:	VG3	0.080 x 0.080 (0.003 x 0.003)
Bond Pad #7:	VD3	0.095 x 0.130 (0.004 x 0.005)
Bond Pad #8:	RF OUT	0.130 x 0.205 (0.005 x 0.008)
Bond Pad #9:	VD3	0.095 x 0.130 (0.004 x 0.005)
Bond Pad #10:	VG3	0.080 x 0.080 (0.003 x 0.003)
Bond Pad #11:	VD2	0.205 x 0.145 (0.008 x 0.006)
Bond Pad #12:	VG2	0.105 x 0.105 (0.004 x 0.004)
Bond Pad #13:	VD1	0.145 x 0.105 (0.006 x 0.004)
Bond Pad #14:	VG1	0.080 x 0.080 (0.003 x 0.003)

GaAs MMIC devices are susceptible to damage from Electrostatic Discharge. Proper precautions should be observed during handling, assembly and test.

**Recommended Chip Assembly & Bonding Diagram
Both-Sided Biasing Option**

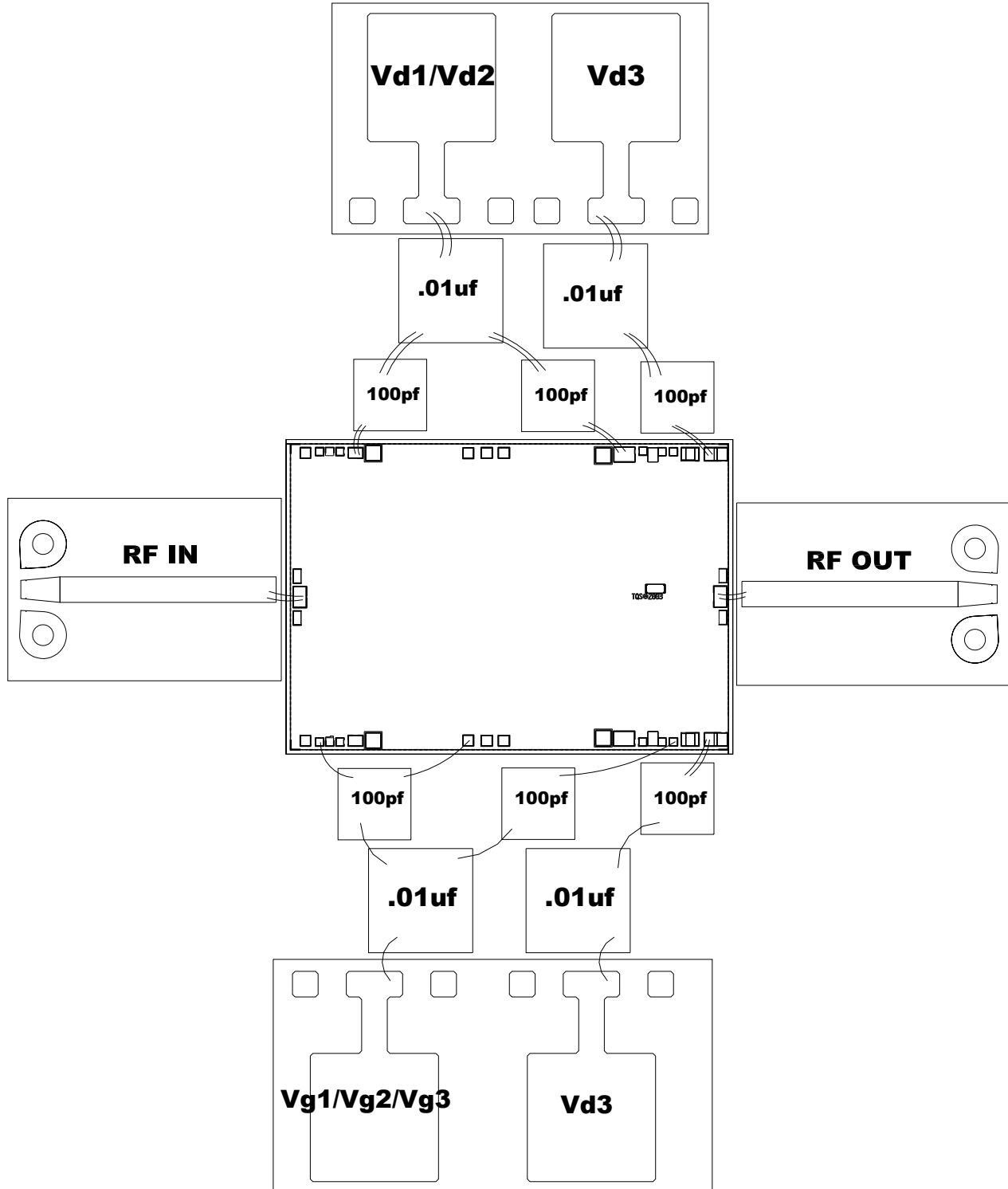

GaAs MMIC devices are susceptible to damage from Electrostatic Discharge. Proper precautions should be observed during handling, assembly and test.

Alternative Chip Assembly & Bonding Diagram Single-Side Biasing Option

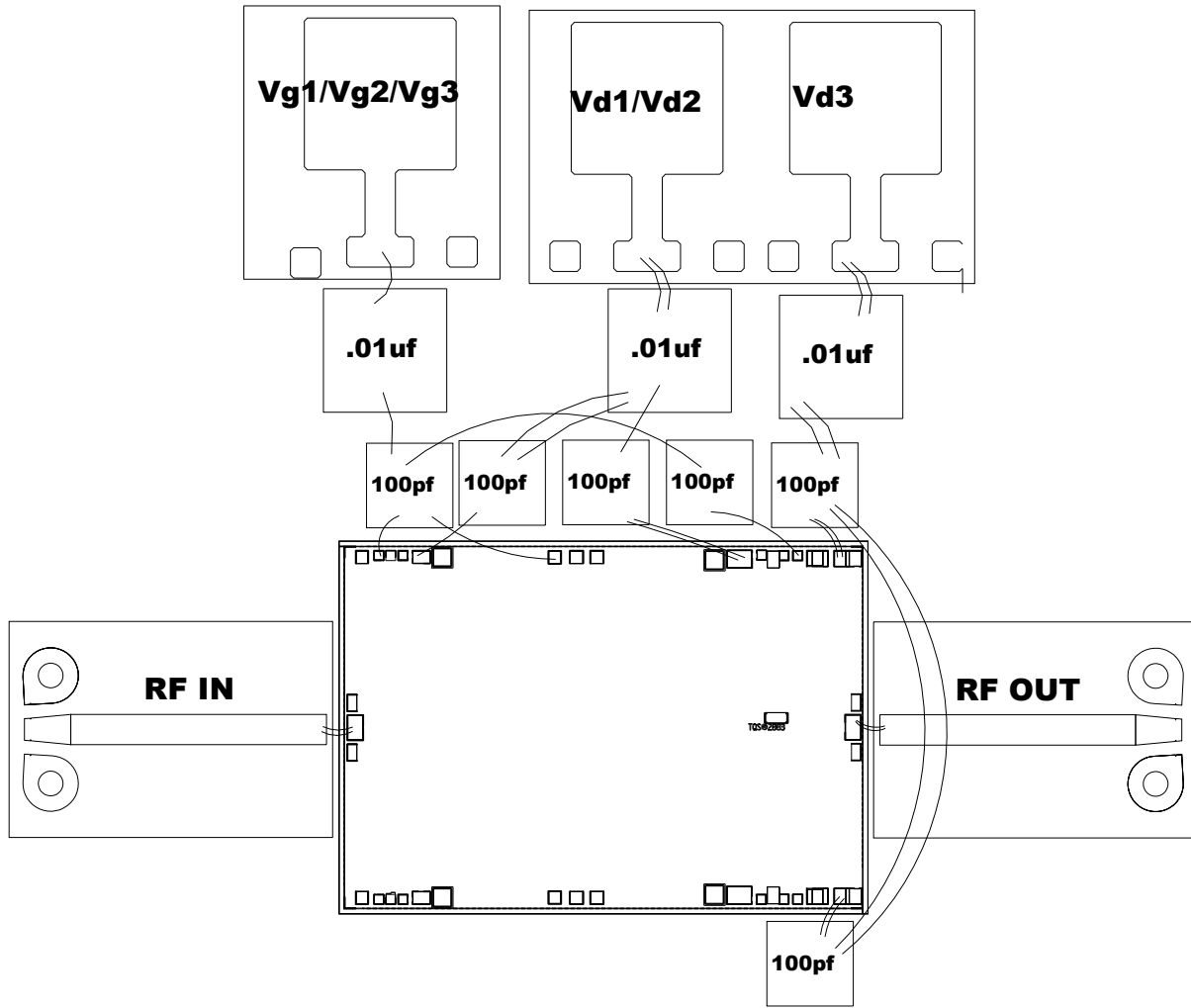

GaAs MMIC devices are susceptible to damage from Electrostatic Discharge. Proper precautions should be observed during handling, assembly and test.

Assembly Process Notes

Reflow process assembly notes:

- Use AuSn (80/20) solder with limited exposure to temperatures at or above 300°C (for 30 sec max).
- An alloy station or conveyor furnace with reducing atmosphere should be used.
- No fluxes should be utilized.
- Coefficient of thermal expansion matching is critical for long-term reliability.
- Devices must be stored in a dry nitrogen atmosphere.

Component placement and adhesive attachment assembly notes:

- Vacuum pencils and/or vacuum collets are the preferred method of pick up.
- Air bridges must be avoided during placement.
- The force impact is critical during auto placement.
- Organic attachment can be used in low-power applications.
- Curing should be done in a convection oven; proper exhaust is a safety concern.
- Microwave or radiant curing should not be used because of differential heating.
- Coefficient of thermal expansion matching is critical.

Interconnect process assembly notes:

- Thermosonic ball bonding is the preferred interconnect technique.
- Force, time, and ultrasonics are critical parameters.
- Aluminum wire should not be used.
- Discrete FET devices with small pad sizes should be bonded with 0.0007-inch wire.
- Maximum stage temperature is 200°C.

GaAs MMIC devices are susceptible to damage from Electrostatic Discharge. Proper precautions should be observed during handling, assembly and test.