

Applications

- Switch Mode Power Supply (SMPS)
- Uninterruptable Power Supply
- High speed power switching
- Lead-Free

V_{DSS}	$R_{ds(on)}$ max	I_D
500V	0.85Ω	8.0A

Benefits

- Low Gate Charge Q_g results in Simple Drive Requirement
- Improved Gate, Avalanche and dynamic dv/dt Ruggedness
- Fully Characterized Capacitance and Avalanche Voltage and Current
- Effective C_{oss} Specified (See AN1001)

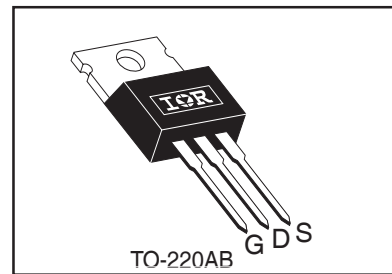

Absolute Maximum Ratings

	Parameter	Max.	Units
I_D @ $T_C = 25^\circ\text{C}$	Continuous Drain Current, V_{GS} @ 10V	8.0	A
I_D @ $T_C = 100^\circ\text{C}$	Continuous Drain Current, V_{GS} @ 10V	5.1	
I_{DM}	Pulsed Drain Current ①	32	
P_D @ $T_C = 25^\circ\text{C}$	Power Dissipation	125	W
	Linear Derating Factor	1.0	W/°C
V_{GS}	Gate-to-Source Voltage	± 30	V
dv/dt	Peak Diode Recovery dv/dt ③	5.0	V/ns
T_J	Operating Junction and	-55 to + 150	°C
T_{STG}	Storage Temperature Range		
	Soldering Temperature, for 10 seconds	300 (1.6mm from case)	
	Mounting torque, 6-32 or M3 screw	10 lbf•in (1.1N•m)	

Typical SMPS Topologies:

- Two Transistor Forward
- Haft Bridge
- Full Bridge

11/11/03

IRF840APbF

International
IR Rectifier

Static @ $T_J = 25^\circ\text{C}$ (unless otherwise specified)

	Parameter	Min.	Typ.	Max.	Units	Conditions
$V_{(BR)DSS}$	Drain-to-Source Breakdown Voltage	500	—	—	V	$V_{GS} = 0V, I_D = 250\mu A$
$\Delta V_{(BR)DSS}/\Delta T_J$	Breakdown Voltage Temp. Coefficient	—	0.58	—	V/ $^\circ\text{C}$	Reference to $25^\circ\text{C}, I_D = 1\text{mA}$
$R_{DS(on)}$	Static Drain-to-Source On-Resistance	—	—	0.85	Ω	$V_{GS} = 10V, I_D = 4.8A$ ④
$V_{GS(th)}$	Gate Threshold Voltage	2.0	—	4.0	V	$V_{DS} = V_{GS}, I_D = 250\mu A$
I_{DSS}	Drain-to-Source Leakage Current	—	—	25 250	μA	$V_{DS} = 500V, V_{GS} = 0V$ $V_{DS} = 400V, V_{GS} = 0V, T_J = 125^\circ\text{C}$
I_{GSS}	Gate-to-Source Forward Leakage	—	—	100	nA	$V_{GS} = 30V$
	Gate-to-Source Reverse Leakage	—	—	-100		$V_{GS} = -30V$

Dynamic @ $T_J = 25^\circ\text{C}$ (unless otherwise specified)

	Parameter	Min.	Typ.	Max.	Units	Conditions
g_{fs}	Forward Transconductance	3.7	—	—	S	$V_{DS} = 50V, I_D = 4.8A$
Q_g	Total Gate Charge	—	—	38	nC	$I_D = 8.0A$ $V_{DS} = 400V$ $V_{GS} = 10V$, See Fig. 6 and 13 ④
Q_{gs}	Gate-to-Source Charge	—	—	9.0		
Q_{gd}	Gate-to-Drain ("Miller") Charge	—	—	18	ns	$V_{DD} = 250V$ $I_D = 8.0A$ $R_G = 9.1\Omega$ $R_D = 31\Omega$, See Fig. 10 ④
$t_{d(on)}$	Turn-On Delay Time	—	11	—		
t_r	Rise Time	—	23	—		
$t_{d(off)}$	Turn-Off Delay Time	—	26	—		
t_f	Fall Time	—	19	—		
C_{iss}	Input Capacitance	—	1018	—	pF	$V_{GS} = 0V$ $V_{DS} = 25V$ $f = 1.0\text{MHz}$, See Fig. 5 $V_{GS} = 0V, V_{DS} = 1.0V, f = 1.0\text{MHz}$ $V_{GS} = 0V, V_{DS} = 400V, f = 1.0\text{MHz}$ $V_{GS} = 0V, V_{DS} = 0V$ to $400V$ ⑤
C_{oss}	Output Capacitance	—	155	—		
C_{rss}	Reverse Transfer Capacitance	—	8.0	—		
C_{oss}	Output Capacitance	—	1490	—		
C_{oss}	Output Capacitance	—	42	—		
$C_{oss \text{ eff.}}$	Effective Output Capacitance	—	56	—		

Avalanche Characteristics

	Parameter	Typ.	Max.	Units
E_{AS}	Single Pulse Avalanche Energy②	—	510	mJ
I_{AR}	Avalanche Current①	—	8.0	A
E_{AR}	Repetitive Avalanche Energy①	—	13	mJ

Thermal Resistance

	Parameter	Typ.	Max.	Units
$R_{\theta JC}$	Junction-to-Case	—	1.0	$^\circ\text{C/W}$
$R_{\theta CS}$	Case-to-Sink, Flat, Greased Surface	0.50	—	
$R_{\theta JA}$	Junction-to-Ambient	—	62	

Diode Characteristics

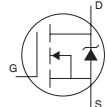
	Parameter	Min.	Typ.	Max.	Units	Conditions
I_S	Continuous Source Current (Body Diode)	—	—	8.0	A	MOSFET symbol showing the integral reverse p-n junction diode. 
I_{SM}	Pulsed Source Current (Body Diode) ①	—	—	32		
V_{SD}	Diode Forward Voltage	—	—	2.0	V	$T_J = 25^\circ\text{C}, I_S = 8.0A, V_{GS} = 0V$ ④
t_{rr}	Reverse Recovery Time	—	422	633	ns	$T_J = 25^\circ\text{C}, I_F = 8.0A$
Q_{rr}	Reverse Recovery Charge	—	2.16	3.24	μC	$di/dt = 100A/\mu\text{s}$ ④
t_{on}	Forward Turn-On Time	Intrinsic turn-on time is negligible (turn-on is dominated by $L_S + L_D$)				

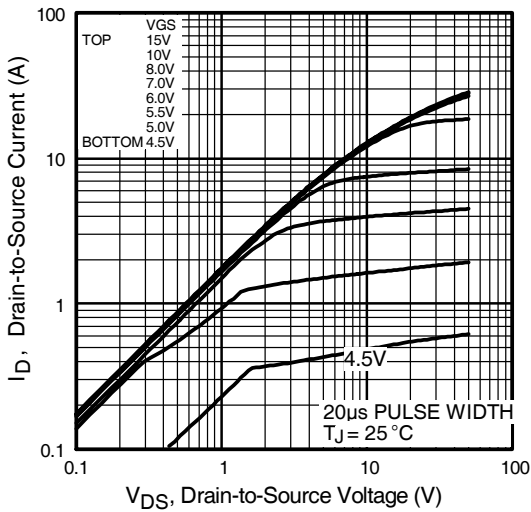

Fig 1. Typical Output Characteristics

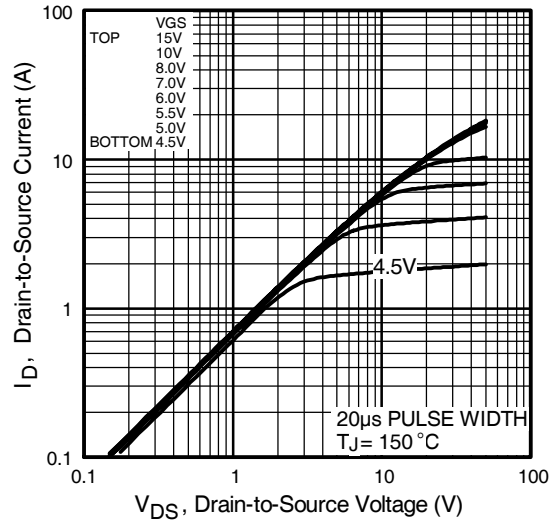

Fig 2. Typical Output Characteristics

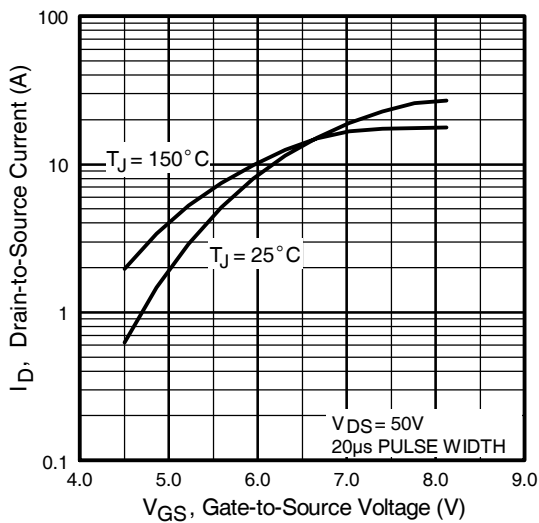

Fig 3. Typical Transfer Characteristics

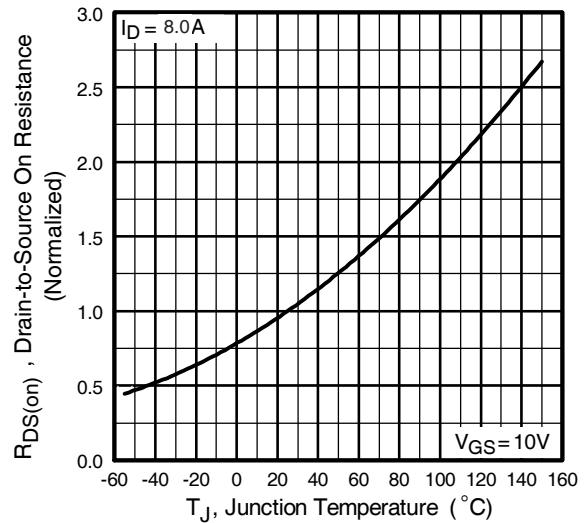

Fig 4. Normalized On-Resistance Vs. Temperature

IRF840APbF

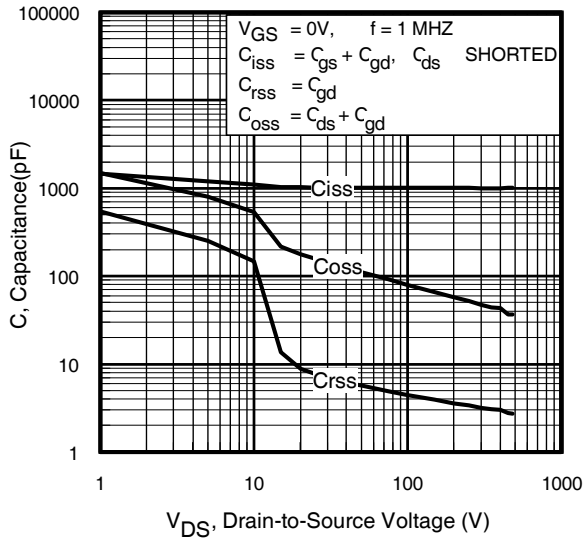

Fig 5. Typical Capacitance Vs. Drain-to-Source Voltage

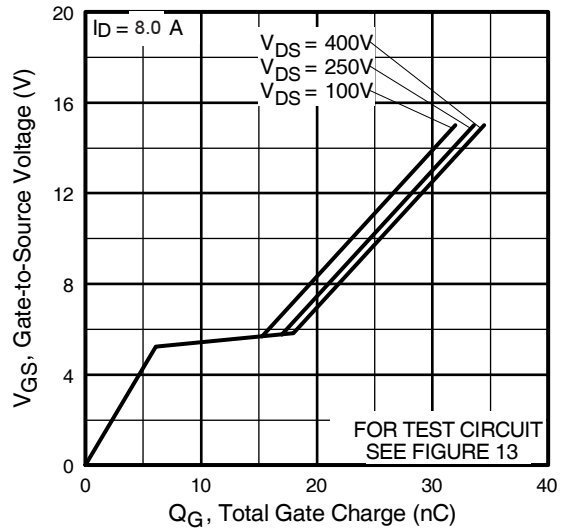

Fig 6. Typical Gate Charge Vs. Gate-to-Source Voltage

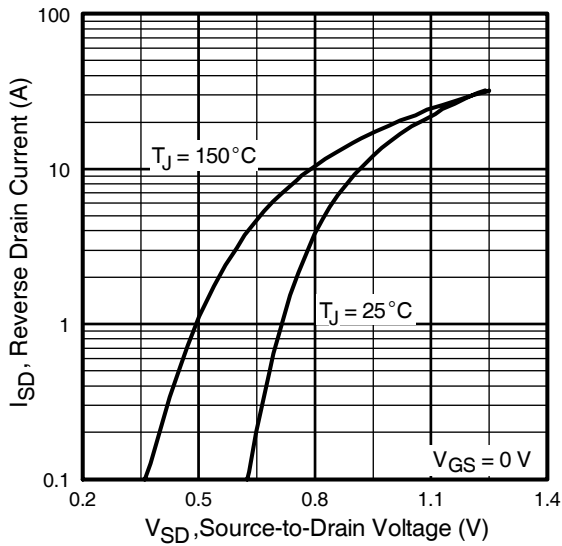

Fig 7. Typical Source-Drain Diode Forward Voltage

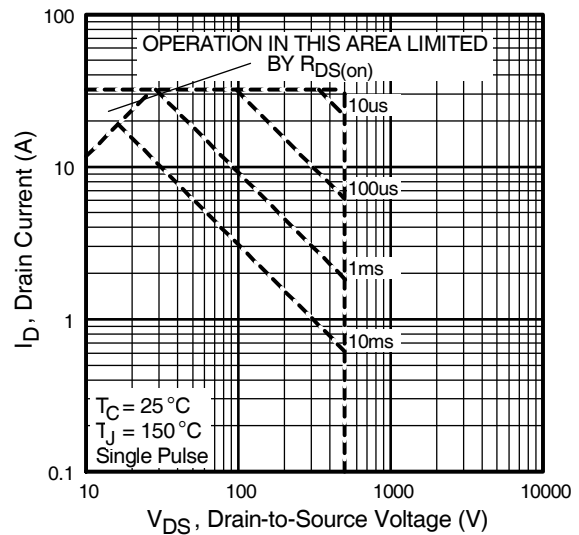

Fig 8. Maximum Safe Operating Area

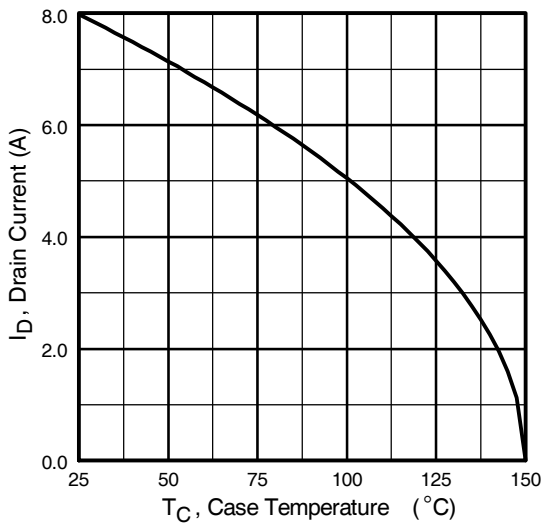

Fig 9. Maximum Drain Current Vs. Case Temperature

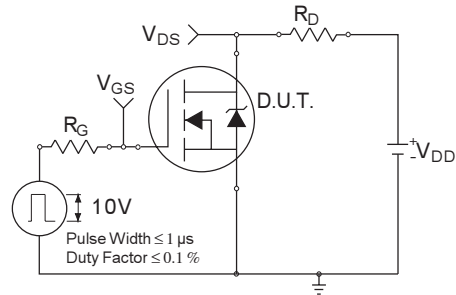

Fig 10a. Switching Time Test Circuit

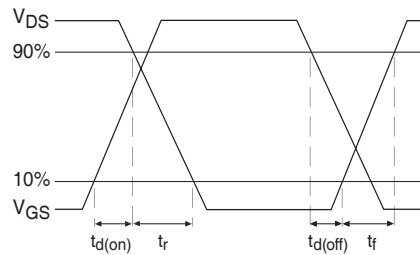

Fig 10b. Switching Time Waveforms

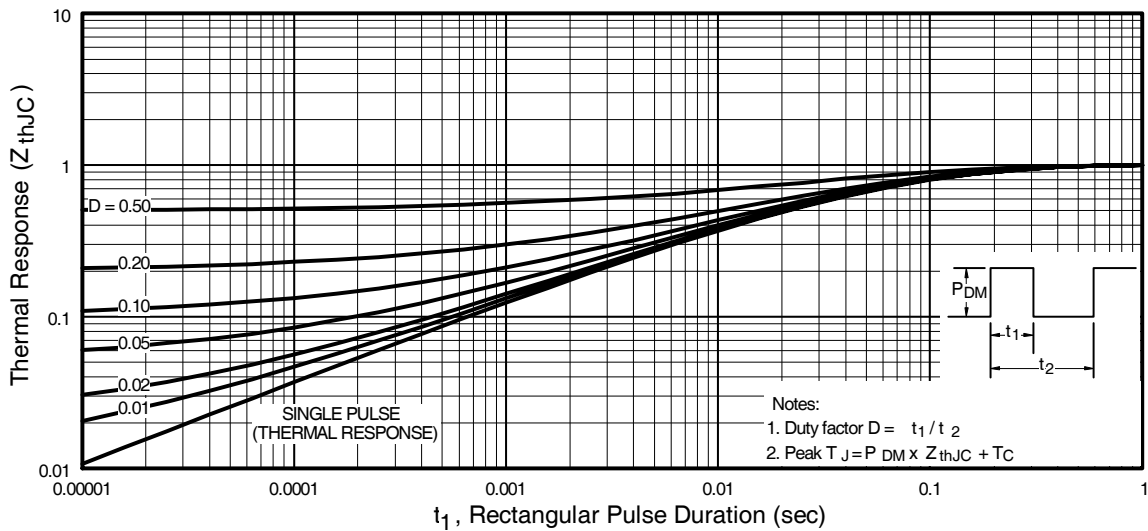

Fig 11. Maximum Effective Transient Thermal Impedance, Junction-to-Case

IRF840APbF

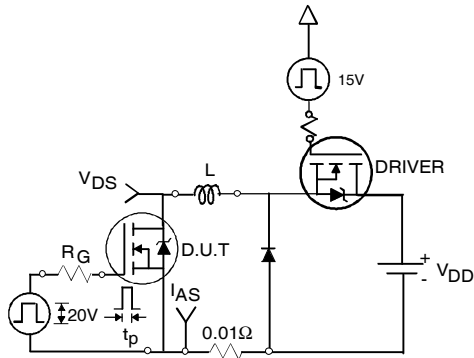

Fig 12a. Unclamped Inductive Test Circuit

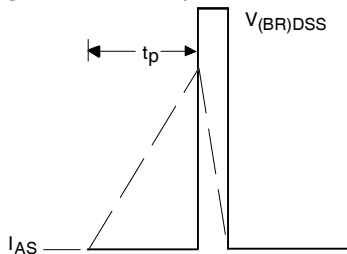

Fig 12b. Unclamped Inductive Waveforms

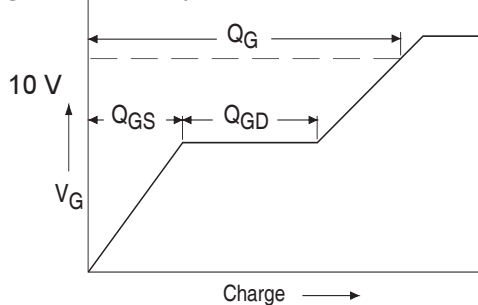

Fig 13a. Basic Gate Charge Waveform

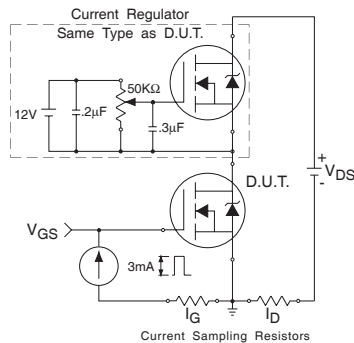

Fig 13b. Gate Charge Test Circuit

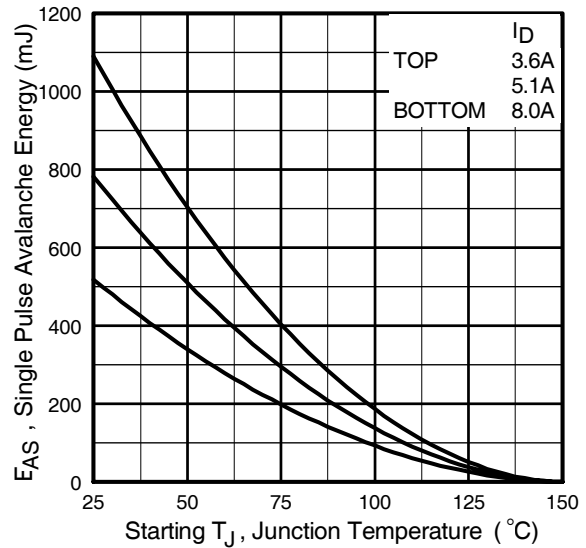

Fig 12c. Maximum Avalanche Energy Vs. Drain Current

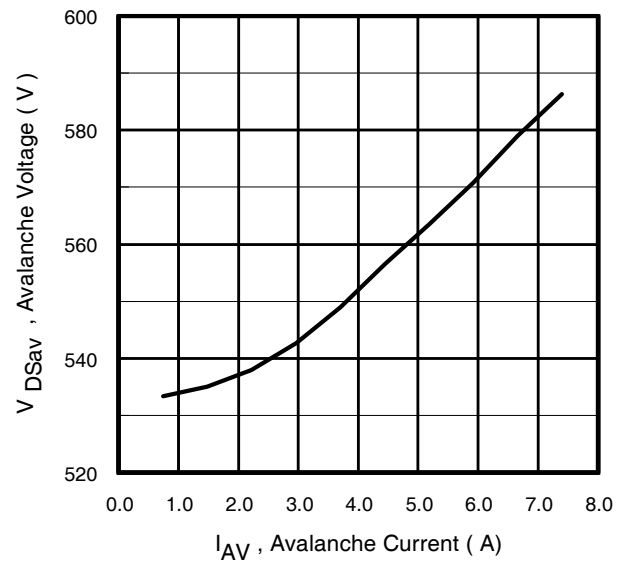
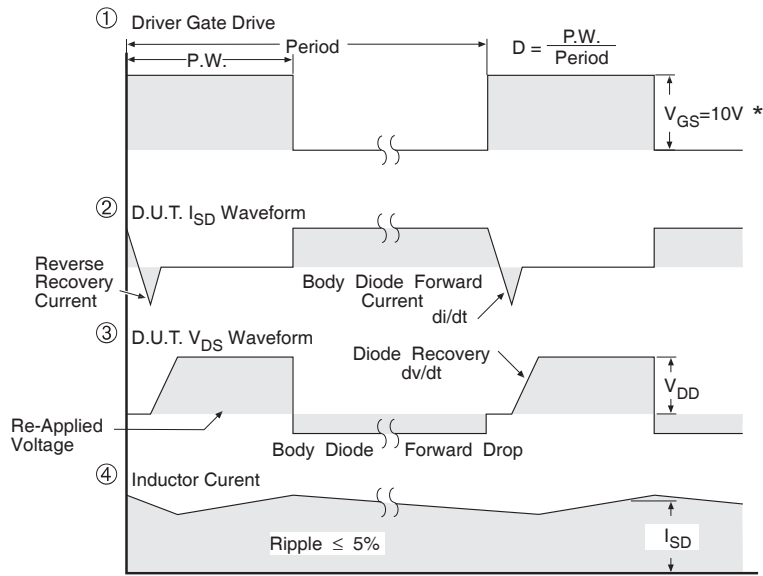
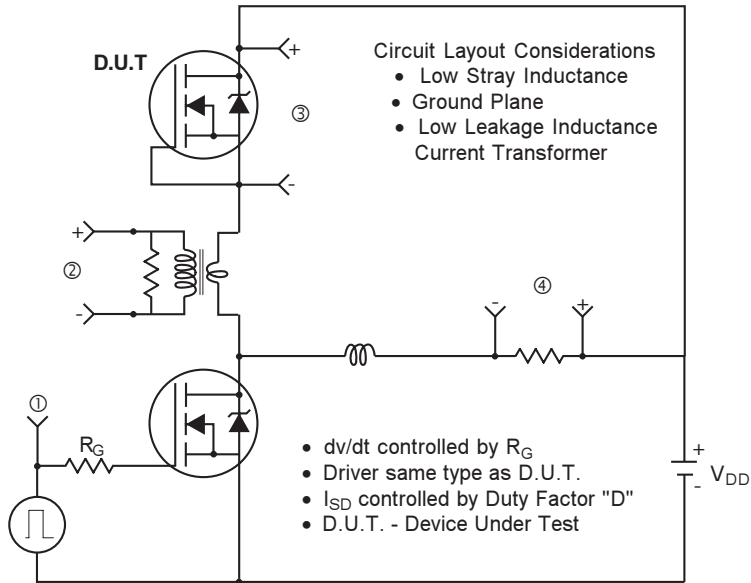

Fig 12d. Typical Drain-to-Source Voltage Vs. Avalanche Current

Peak Diode Recovery dv/dt Test Circuit



* $V_{GS} = 5V$ for Logic Level Devices

Fig 14. For N-Channel HEXFETS

IRF840APbF



TO-220AB Package Outline

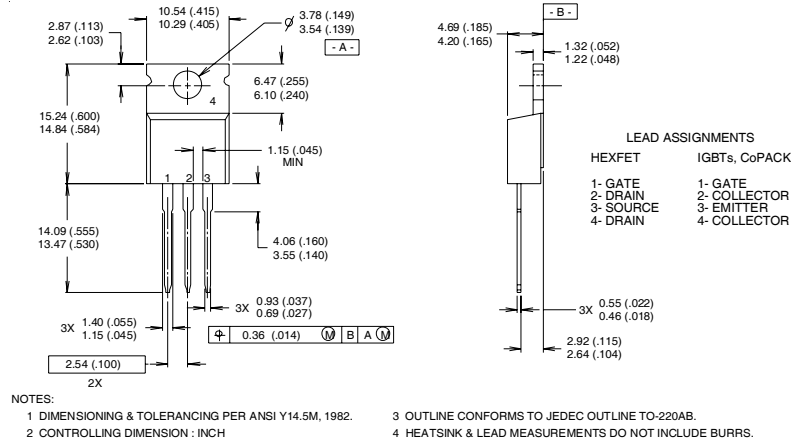

TO-220AB Part Marking Information

EXAMPLE: THIS IS AN IRF1010
 LOT CODE 1789
 ASSEMBLED ON WW 19, 1997
 IN THE ASSEMBLY LINE "C"
Note: "P" in assembly line
 position indicates "Lead-Free"

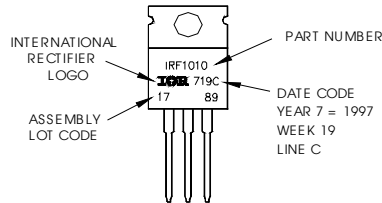

Notes:

- ① Repetitive rating; pulse width limited by max. junction temperature. (See fig. 11)
- ② Starting $T_J = 25^\circ\text{C}$, $L = 16\text{ mH}$
 $R_G = 25\Omega$, $I_{AS} = 8.0\text{A}$. (See Figure 12)
- ③ $I_{SD} \leq 8.0\text{A}$, $di/dt \leq 100\text{A}/\mu\text{s}$, $V_{DD} \leq V_{(BR)DSS}$,
 $T_J \leq 150^\circ\text{C}$
- ④ Pulse width $\leq 300\mu\text{s}$; duty cycle $\leq 2\%$.
- ⑤ $C_{oss\text{ eff}}$ is a fixed capacitance that gives the same charging time as C_{oss} while V_{DS} is rising from 0 to 80% V_{DSS}

Data and specifications subject to change without notice.



IR WORLD HEADQUARTERS: 233 Kansas St., El Segundo, California 90245, USA Tel: (310) 252-7105
 TAC Fax: (310) 252-7903

11/03



Notice

The products described herein were acquired by Vishay Intertechnology, Inc., as part of its acquisition of International Rectifier's Power Control Systems (PCS) business, which closed in April 2007. Specifications of the products displayed herein are pending review by Vishay and are subject to the terms and conditions shown below.

Specifications of the products displayed herein are subject to change without notice. Vishay Intertechnology, Inc., or anyone on its behalf, assumes no responsibility or liability for any errors or inaccuracies.

Information contained herein is intended to provide a product description only. No license, express or implied, by estoppel or otherwise, to any intellectual property rights is granted by this document. Except as provided in Vishay's terms and conditions of sale for such products, Vishay assumes no liability whatsoever, and disclaims any express or implied warranty, relating to sale and/or use of Vishay products including liability or warranties relating to fitness for a particular purpose, merchantability, or infringement of any patent, copyright, or other intellectual property right.

The products shown herein are not designed for use in medical, life-saving, or life-sustaining applications. Customers using or selling these products for use in such applications do so at their own risk and agree to fully indemnify Vishay for any damages resulting from such improper use or sale.

International Rectifier®, IR®, the IR logo, HEXFET®, HEXSense®, HEXDIP®, DOL®, INTERO®, and POWIRTRAIN® are registered trademarks of International Rectifier Corporation in the U.S. and other countries. All other product names noted herein may be trademarks of their respective owners.