

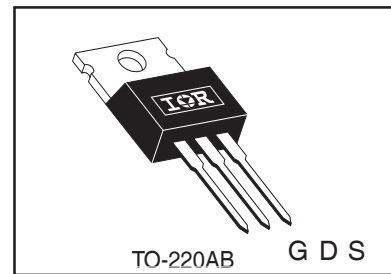
**Applications**

- Switch Mode Power Supply ( SMPS )
- Uninterruptable Power Supply
- High speed power switching
- Lead-Free

<b>V<sub>DSS</sub></b>	<b>R<sub>ds(on)</sub> max</b>	<b>I<sub>D</sub></b>
<b>400V</b>	<b>0.55Ω</b>	<b>10A</b>

**Benefits**

- Low Gate Charge Q<sub>g</sub> results in Simple Drive Requirement
- Improved Gate, Avalanche and dynamic dv/dt Ruggedness
- Fully Characterized Capacitance and Avalanche Voltage and Current
- Effective Coss specified ( See AN 1001)



**Absolute Maximum Ratings**

	<b>Parameter</b>	<b>Max.</b>	<b>Units</b>
I <sub>D</sub> @ T <sub>C</sub> = 25°C	Continuous Drain Current, V <sub>GS</sub> @ 10V	10	A
I <sub>D</sub> @ T <sub>C</sub> = 100°C	Continuous Drain Current, V <sub>GS</sub> @ 10V	6.3	
I <sub>DM</sub>	Pulsed Drain Current ①	40	
P <sub>D</sub> @ T <sub>C</sub> = 25°C	Power Dissipation	125	W
	Linear Derating Factor	1.0	W/°C
V <sub>GS</sub>	Gate-to-Source Voltage	± 30	V
dv/dt	Peak Diode Recovery dv/dt ③	5.9	V/ns
T <sub>J</sub>	Operating Junction and	-55 to + 150	°C
T <sub>STG</sub>	Storage Temperature Range		
	Soldering Temperature, for 10 seconds	300 (1.6mm from case )	
	Mounting torque, 6-32 or M3 screw	10 lbf•in (1.1N•m)	

**Typical SMPS Topologies:**

- Single transistor Flyback Xfmr. Reset
- Single Transistor Forward Xfmr. Reset  
( Both for US Line Input only )

Notes ① through ⑤ are on page 8

11/10/03

Document Number: 91051

www.vishay.com

1

# IRF740APbF

International  
IR Rectifier

Static @  $T_J = 25^\circ\text{C}$  (unless otherwise specified)

	Parameter	Min.	Typ.	Max.	Units	Conditions
$V_{(BR)DSS}$	Drain-to-Source Breakdown Voltage	400	—	—	V	$V_{GS} = 0V, I_D = 250\mu A$
$\Delta V_{(BR)DSS}/\Delta T_J$	Breakdown Voltage Temp. Coefficient	—	0.48	—		$V/^\circ\text{C}$ Reference to $25^\circ\text{C}, I_D = 1\text{mA}$
$R_{DS(on)}$	Static Drain-to-Source On-Resistance	—	—	0.55	$\Omega$	$V_{GS} = 10V, I_D = 6.0A$ ④
$V_{GS(th)}$	Gate Threshold Voltage	2.0	—	4.0	V	$V_{DS} = V_{GS}, I_D = 250\mu A$
$I_{DSS}$	Drain-to-Source Leakage Current	—	—	25	$\mu A$	$V_{DS} = 400V, V_{GS} = 0V$
		—	—	250		$V_{DS} = 320V, V_{GS} = 0V, T_J = 125^\circ\text{C}$
$I_{GSS}$	Gate-to-Source Forward Leakage	—	—	100	nA	$V_{GS} = 30V$
	Gate-to-Source Reverse Leakage	—	—	-100		$V_{GS} = -30V$

Dynamic @  $T_J = 25^\circ\text{C}$  (unless otherwise specified)

	Parameter	Min.	Typ.	Max.	Units	Conditions
$g_{fs}$	Forward Transconductance	4.9	—	—	S	$V_{DS} = 50V, I_D = 6.0A$
$Q_g$	Total Gate Charge	—	—	36	nC	$I_D = 10A$ $V_{DS} = 320V$ $V_{GS} = 10V$ , See Fig. 6 and 13 ④
$Q_{gs}$	Gate-to-Source Charge	—	—	9.9		
$Q_{gd}$	Gate-to-Drain ("Miller") Charge	—	—	16		
$t_{d(on)}$	Turn-On Delay Time	—	10	—		
$t_r$	Rise Time	—	35	—	ns	$V_{DD} = 200V$ $I_D = 10A$ $R_G = 10\Omega$ $R_D = 19.5\Omega$ , See Fig. 10 ④
$t_{d(off)}$	Turn-Off Delay Time	—	24	—		
$t_f$	Fall Time	—	22	—		
$C_{iss}$	Input Capacitance	—	1030	—	pF	$V_{GS} = 0V$ $V_{DS} = 25V$ $f = 1.0\text{MHz}$ , See Fig. 5
$C_{oss}$	Output Capacitance	—	170	—		
$C_{rss}$	Reverse Transfer Capacitance	—	7.7	—		
$C_{oss}$	Output Capacitance	—	1490	—		
$C_{oss}$	Output Capacitance	—	52	—		
$C_{oss}$	Output Capacitance	—	52	—		
$C_{oss\ eff.}$	Effective Output Capacitance	—	61	—		

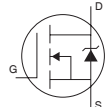
## Avalanche Characteristics

	Parameter	Typ.	Max.	Units
$E_{AS}$	Single Pulse Avalanche Energy②	—	630	mJ
$I_{AR}$	Avalanche Current①	—	10	A
$E_{AR}$	Repetitive Avalanche Energy①	—	12.5	mJ

## Thermal Resistance

	Parameter	Typ.	Max.	Units
$R_{\theta JC}$	Junction-to-Case	—	1.0	$^\circ\text{C/W}$
$R_{\theta CS}$	Case-to-Sink, Flat, Greased Surface	0.50	—	
$R_{\theta JA}$	Junction-to-Ambient	—	62	

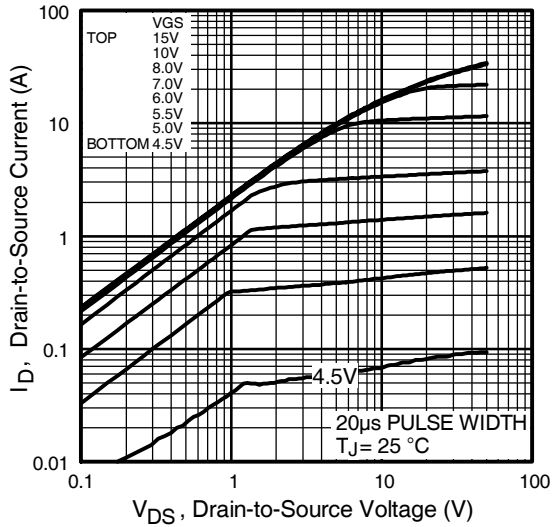
## Diode Characteristics

	Parameter	Min.	Typ.	Max.	Units	Conditions
$I_S$	Continuous Source Current (Body Diode)	—	—	10	A	MOSFET symbol showing the integral reverse p-n junction diode. 
$I_{SM}$	Pulsed Source Current (Body Diode) ①	—	—	40		
$V_{SD}$	Diode Forward Voltage	—	—	2.0	V	$T_J = 25^\circ\text{C}, I_S = 10A, V_{GS} = 0V$ ④
$t_{rr}$	Reverse Recovery Time	—	240	360	ns	$T_J = 25^\circ\text{C}, I_F = 10A$
$Q_{rr}$	Reverse Recovery Charge	—	1.9	2.9	$\mu\text{C}$	$di/dt = 100A/\mu\text{s}$ ④
$t_{on}$	Forward Turn-On Time	Intrinsic turn-on time is negligible (turn-on is dominated by $L_S+L_D$ )				

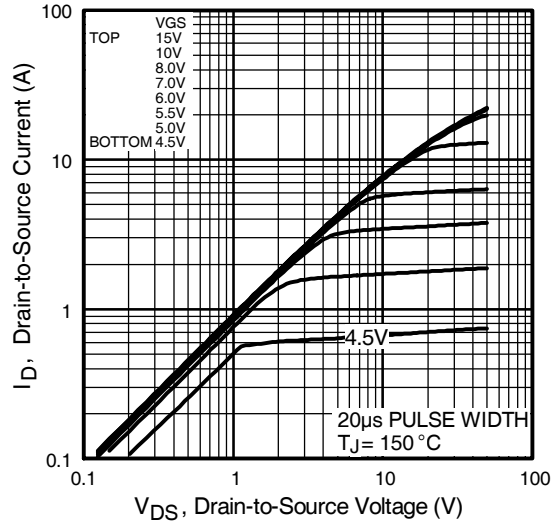
Document Number: 91051

www.vishay.com

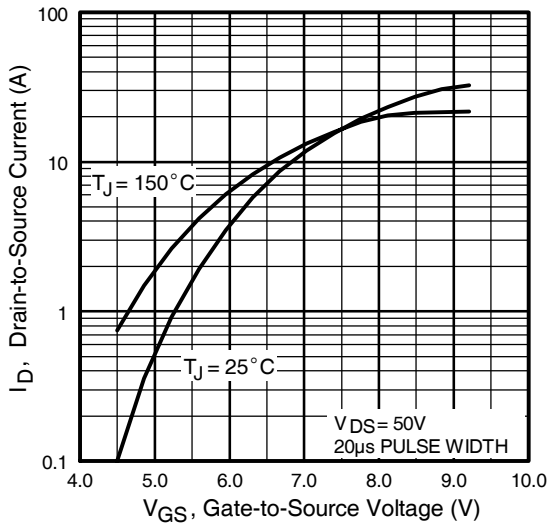
2



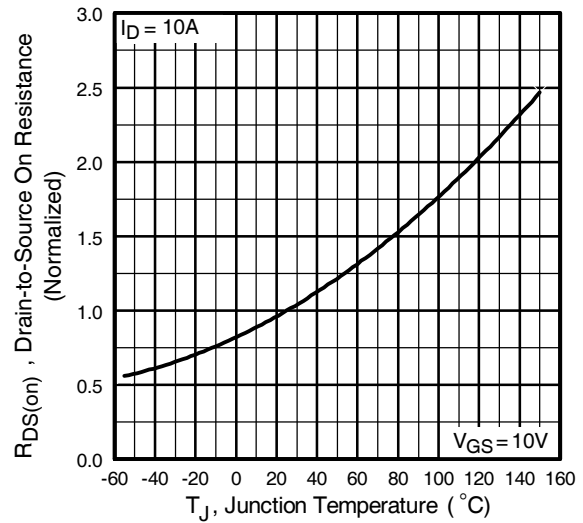
**Fig 1.** Typical Output Characteristics



**Fig 2.** Typical Output Characteristics

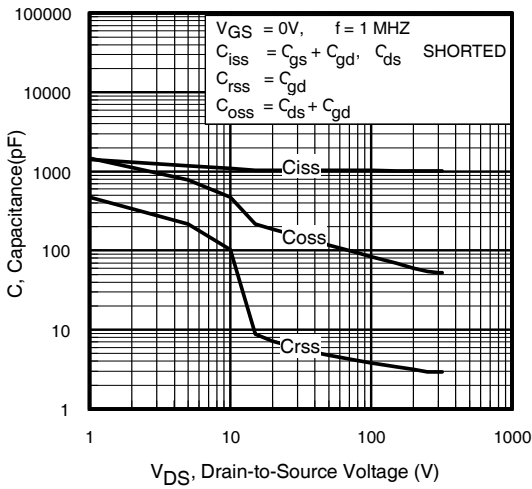


**Fig 3.** Typical Transfer Characteristics

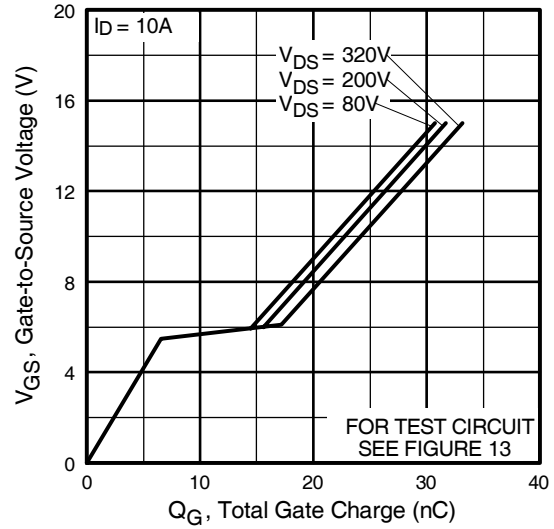


**Fig 4.** Normalized On-Resistance Vs. Temperature

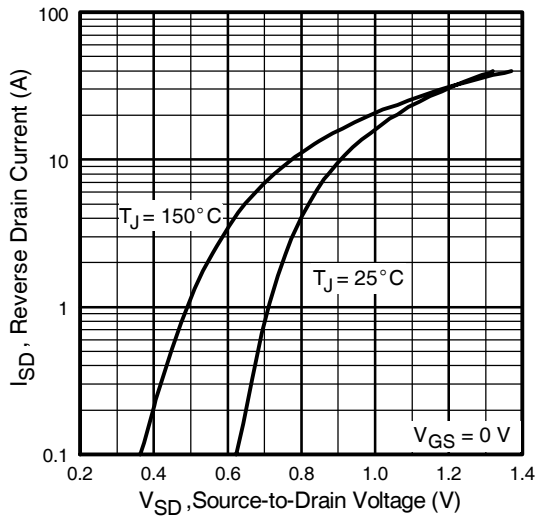
# IRF740APbF



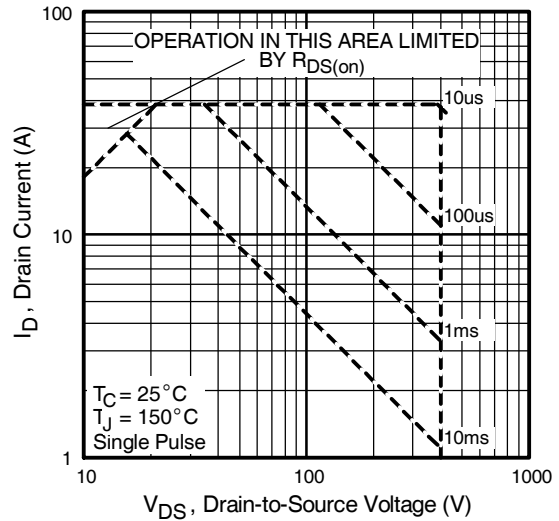
**Fig 5.** Typical Capacitance Vs. Drain-to-Source Voltage



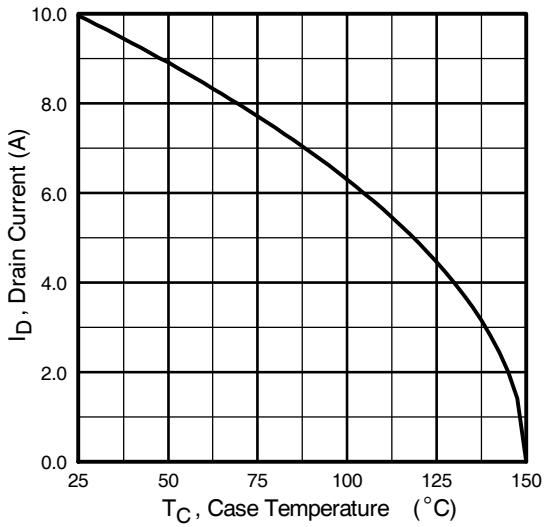
**Fig 6.** Typical Gate Charge Vs. Gate-to-Source Voltage



**Fig 7.** Typical Source-Drain Diode Forward Voltage



**Fig 8.** Maximum Safe Operating Area



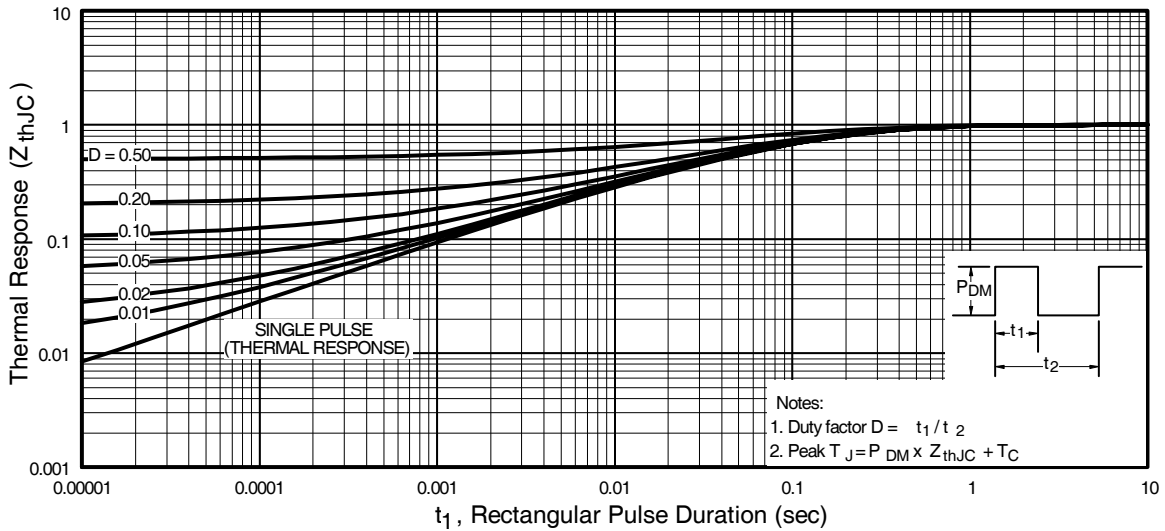
**Fig 9.** Maximum Drain Current Vs. Case Temperature



**Fig 10a.** Switching Time Test Circuit

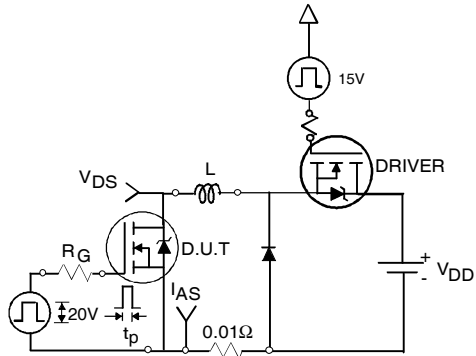


**Fig 10b.** Switching Time Waveforms

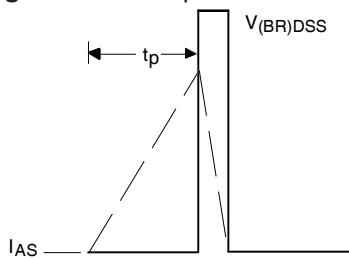


**Fig 11.** Maximum Effective Transient Thermal Impedance, Junction-to-Case

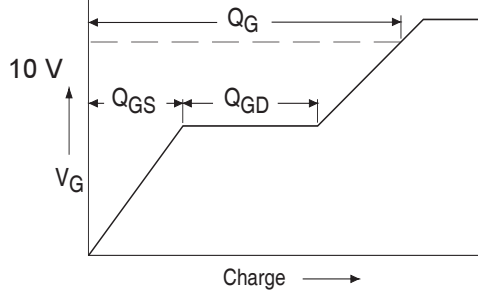
# IRF740APbF



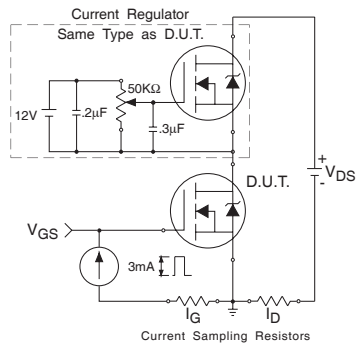
**Fig 12a.** Unclamped Inductive Test Circuit



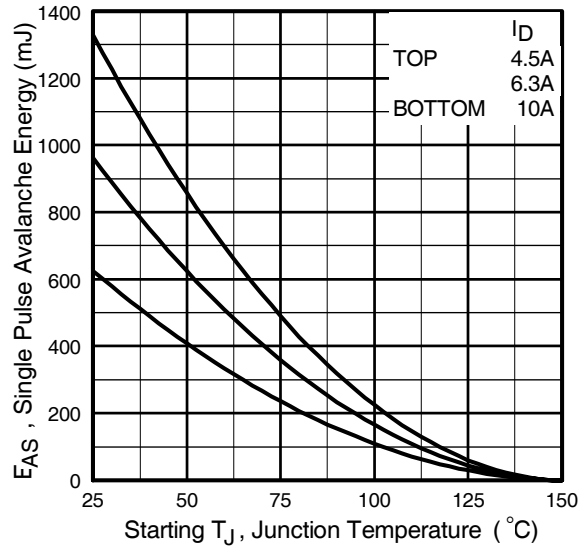
**Fig 12b.** Unclamped Inductive Waveforms



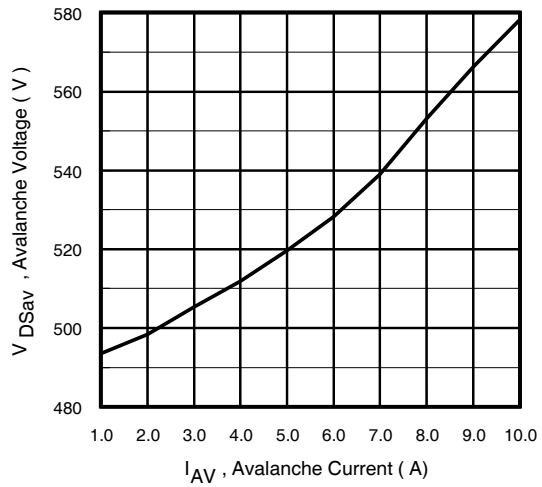
**Fig 13a.** Basic Gate Charge Waveform



**Fig 13b.** Gate Charge Test Circuit

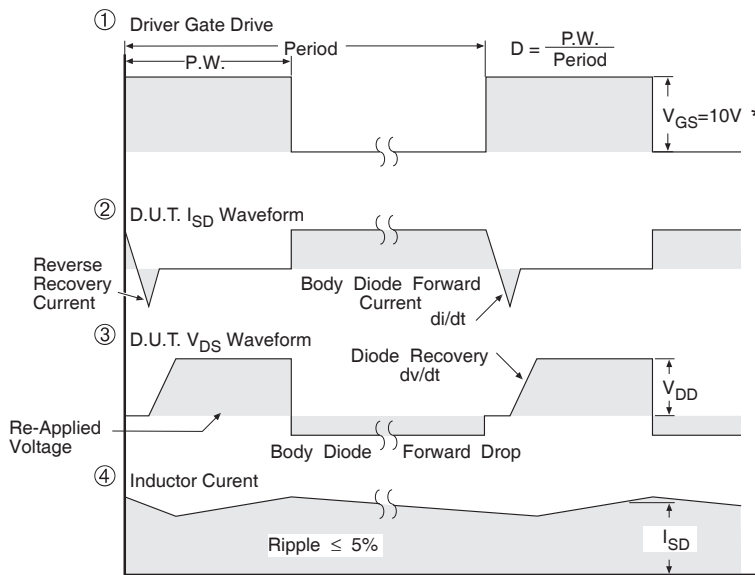
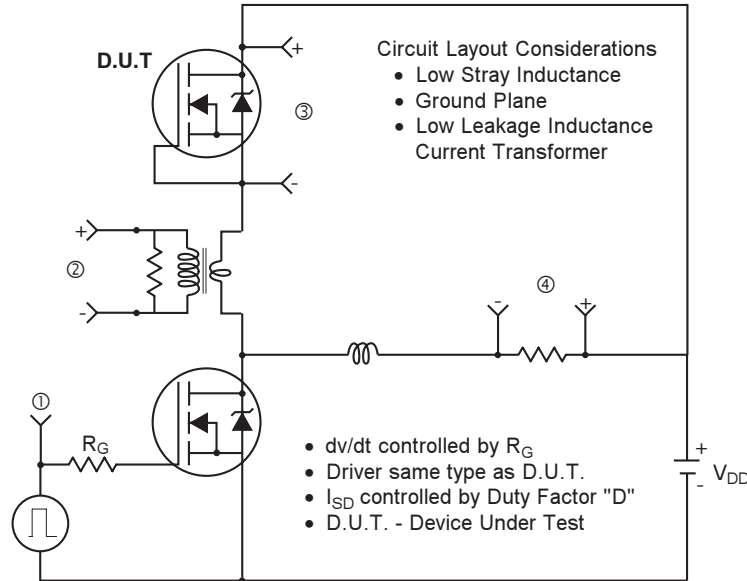


**Fig 12c.** Maximum Avalanche Energy Vs. Drain Current



**Fig 12d.** Typical Drain-to-Source Voltage Vs. Avalanche Current

## Peak Diode Recovery dv/dt Test Circuit



\*  $V_{GS} = 5V$  for Logic Level Devices

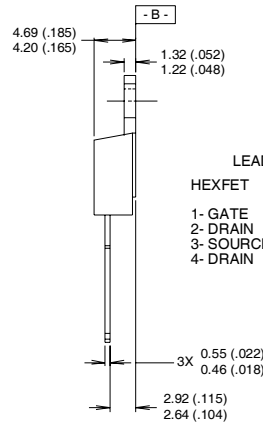
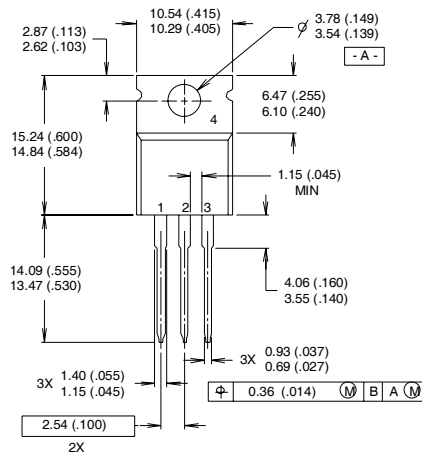
**Fig 14.** For N-Channel HEXFETS

# IRF740APbF

International  
**IR** Rectifier

## TO-220AB Package Outline

Dimensions are shown in millimeters (inches)



### LEAD ASSIGNMENTS

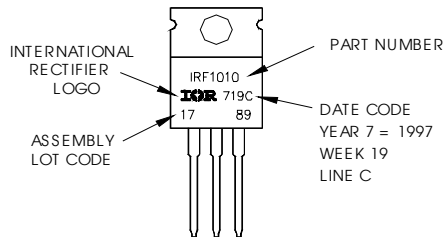
HEXFET	IGBTs, CoPACK
1- GATE	1- GATE
2- DRAIN	2- COLLECTOR
3- SOURCE	3- EMITTER
4- DRAIN	4- COLLECTOR

### NOTES:

- 1 DIMENSIONING & TOLERANCING PER ANSI Y14.5M, 1982.
- 2 CONTROLLING DIMENSION : INCH
- 3 OUTLINE CONFORMS TO JEDEC OUTLINE TO-220AB.
- 4 HEATSINK & LEAD MEASUREMENTS DO NOT INCLUDE BURRS.

## TO-220AB Part Marking Information

EXAMPLE: THIS IS AN IRF1010  
 LOT CODE 1789  
 ASSEMBLED ON WW 19, 1997  
 IN THE ASSEMBLY LINE "C"  
**Note:** "P" in assembly line position indicates "Lead-Free"



### Notes:

- ① Repetitive rating; pulse width limited by max. junction temperature. ( See fig. 11 )
- ② Starting  $T_J = 25^\circ\text{C}$ ,  $L = 12.6\text{mH}$   
 $R_G = 25\Omega$ ,  $I_{AS} = 10\text{A}$ . (See Figure 12)
- ③  $I_{SD} \leq 10\text{A}$ ,  $di/dt \leq 330\text{A}/\mu\text{s}$ ,  $V_{DD} \leq V_{(BR)DSS}$ ,  
 $T_J \leq 150^\circ\text{C}$
- ④ Pulse width  $\leq 300\mu\text{s}$ ; duty cycle  $\leq 2\%$ .
- ⑤  $C_{oss\ eff}$  is a fixed capacitance that gives the same charging time as  $C_{oss}$  while  $V_{DS}$  is rising from 0 to 80%  $V_{DSS}$

Data and specifications subject to change without notice.

International  
**IR** Rectifier

IR WORLD HEADQUARTERS: 233 Kansas St., El Segundo, California 90245, USA Tel: (310) 252-7105  
 TAC Fax: (310) 252-7903

11/03

Document Number: 91051

www.vishay.com

8





## Notice

The products described herein were acquired by Vishay Intertechnology, Inc., as part of its acquisition of International Rectifier's Power Control Systems (PCS) business, which closed in April 2007. Specifications of the products displayed herein are pending review by Vishay and are subject to the terms and conditions shown below.

Specifications of the products displayed herein are subject to change without notice. Vishay Intertechnology, Inc., or anyone on its behalf, assumes no responsibility or liability for any errors or inaccuracies.

Information contained herein is intended to provide a product description only. No license, express or implied, by estoppel or otherwise, to any intellectual property rights is granted by this document. Except as provided in Vishay's terms and conditions of sale for such products, Vishay assumes no liability whatsoever, and disclaims any express or implied warranty, relating to sale and/or use of Vishay products including liability or warranties relating to fitness for a particular purpose, merchantability, or infringement of any patent, copyright, or other intellectual property right.

The products shown herein are not designed for use in medical, life-saving, or life-sustaining applications. Customers using or selling these products for use in such applications do so at their own risk and agree to fully indemnify Vishay for any damages resulting from such improper use or sale.

International Rectifier®, IR®, the IR logo, HEXFET®, HEXSense®, HEXDIP®, DOL®, INTERO®, and POWIRTRAIN® are registered trademarks of International Rectifier Corporation in the U.S. and other countries. All other product names noted herein may be trademarks of their respective owners.